



## Features

- Wide input range 180 ~ 528VAC
- Constant Current mode output
- Metal housing with Class I design
- Built-in active PFC function
- IP67 / IP65 design for indoor or outdoor installations
- Function options: output adjustable via potentiometer; 3 in 1 dimming (dim-to-off) ; Smart timer dimming
- Typical lifetime > 50000 hours
- 5 years warranty

## Applications

- LED street lighting
- LED high-bay lighting
- Parking space lighting
- LED fishing lamp
- Type "HL" for use in Class I , Division 2 hazardous (Classified) location.

## GTIN CODE

MW Search: <https://www.meanwell.com/serviceGTIN.aspx>

## Description

HVGC-320 series is a 320W LED AC/DC LED power supply featuring the constant current mode and high voltage output. HVGC-320 operates from 180~528VAC and offers models with different rated current ranging between 700mA and 3500mA. Thanks to the high efficiency up to 93.5%, with the fanless design, the entire series is able to operate for -40°C ~ +90°C case temperature under free air convection. The design of metal housing and IP67/IP65 ingress protection level allows this series to fit both indoor and outdoor applications. HVGC-320 is equipped with various function options, such as dimming methodologies, so as to provide the optimal design flexibility for LED lighting system.

## Model Encoding

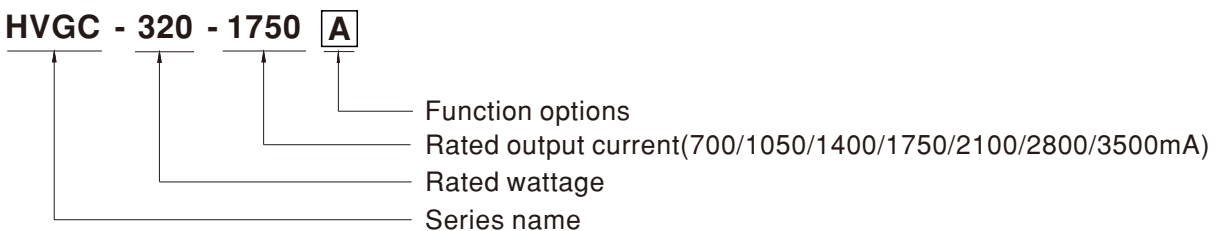

Type	IP Level	Function	Note
A	IP65	Io adjustable through built-in potentiometer.	In Stock
B	IP67	3 in 1 dimming function (0~10Vdc, 10V PWM signal and resistance)	In Stock
AB	IP65	Io adjustable through built-in potentiometer & 3 in 1 dimming function (0~10Vdc, 10V PWM signal and resistance)	In Stock
Dx	IP67	Built-in Smart timer dimming function by user request.	By request
D2	IP67	Built-in Smart timer dimming and programmable function.	By request



**SPECIFICATION**

MODEL		HVGC-320-700 <input type="checkbox"/>	HVGC-320-1050 <input type="checkbox"/>	HVGC-320-1400 <input type="checkbox"/>	HVGC-320-1750 <input type="checkbox"/>	HVGC-320-2100 <input type="checkbox"/>	HVGC-320-2800 <input type="checkbox"/>	HVGC-320-3500 <input type="checkbox"/>	
OUTPUT	RATED CURRENT	700mA	1050mA	1400mA	1750mA	2100mA	2800mA	3500mA	
	RATED POWER	300W	320W	320W	320W	320W	320W	320W	
	CONSTANT CURRENT REGION <small>Note.2</small>	214 ~ 428V	152.4 ~ 304.8V	114.3 ~ 228.6V	91.4~182.8V	76.2 ~ 152.4V	57 ~ 114.3V	45.7 ~ 91.4V	
	OPEN CIRCUIT VOLTAGE (max.)	442V	311V	234V	187V	156V	118V	94V	
	CURRENT ADJ. RANGE	Adjustable for A/AB-Type only (via built-in potentiometer)							
		350~700mA	525~1050mA	700~1400mA	875~1750mA	1050~2100mA	1400~2800mA	1750~3500mA	
	CURRENT RIPPLE	5.0% max. @rated current							
	CURRENT TOLERANCE	±5%							
SET UP TIME <small>Note.4</small>	500ms/230VAC, 347VAC, 480VAC								
INPUT	VOLTAGE RANGE <small>Note.3</small>	180 ~ 528VAC 254VDC ~ 747VDC (Please refer to "STATIC CHARACTERISTIC" section)							
	FREQUENCY RANGE	47 ~ 63Hz							
	POWER FACTOR (Typ.)	PF ≥ 0.98/230VAC, PF ≥ 0.97/277VAC, PF ≥ 0.95/347VAC, PF ≥ 0.93/480VAC @full load (Please refer to "POWER FACTOR (PF) CHARACTERISTIC" section)							
	TOTAL HARMONIC DISTORTION	THD < 20% (@ load ≥ 50%/230VAC, 277VAC, 347VAC, @ load ≥ 60%/480VAC) (Please refer to "TOTAL HARMONIC DISTORTION (THD)" section)							
	EFFICIENCY (Typ.)	93.5%	93.5%	93.5%	93.5%	93.5%	93.5%	93%	
	AC CURRENT (Typ.)	1.1A / 347VAC 0.8A / 480VAC							
	INRUSH CURRENT(Typ.)	COLD START 50A(twidth=920μs measured at 50% Ipeak) at 480VAC; Per NEMA 410							
	MAX. NO. of PSUs on 16A CIRCUIT BREAKER	2 unit(circuit breaker of type B) / 4 units(circuit breaker of type C) at 480VAC							
LEAKAGE CURRENT	<0.75mA / 480VAC								
PROTECTION	SHORT CIRCUIT	Constant current limiting, recovers automatically after fault condition is removed							
	OVER VOLTAGE	445 ~ 455V	320 ~ 351V	240 ~ 263V	192 ~ 210V	160 ~ 175V	120 ~ 131V	96 ~ 105V	
	OVER TEMPERATURE	Shut down o/p voltage with re-power on to recovery Shut down and latch off o/p voltage, re-power on to recover							
ENVIRONMENT	WORKING TEMP.	Tcase=-40 ~ +90°C (Please refer to "OUTPUT LOAD vs TEMPERATURE" section)							
	MAX. CASE TEMP.	Tcase=+90°C							
	WORKING HUMIDITY	20 ~ 95% RH non-condensing							
	STORAGE TEMP., HUMIDITY	-40 ~ +80°C, 10 ~ 95% RH							
	TEMP. COEFFICIENT	±0.03%/°C (0 ~ 60°C)							
VIBRATION	10 ~ 500Hz, 5G 12min./1cycle, period for 72min. each along X, Y, Z axes								
SAFETY & EMC	SAFETY STANDARDS <small>Note.11</small>	UL8750 (type"HL"), CSA C22.2 No. 250.13-12, IEC/BS EN/EN61347-1,IEC/BS EN/EN61347-2-13, BS EN/EN62384 independent, EAC TP TC 004, IP65 or IP67 approved							
	WITHSTAND VOLTAGE	I/P-O/P:3.75KVAC I/P-FG:2KVAC O/P-FG:1.5KVAC							
	ISOLATION RESISTANCE	I/P-O/P, I/P-FG, O/P-FG:100M Ohms / 500VDC / 25°C / 70% RH							
	EMC EMISSION	Compliance to FCC Part 15 Subpart B, BS EN/EN55015, BS EN/EN61000-3-2(@load ≥ 50%), BS EN/EN61000-3-3, EAC TP TC 020							
EMC IMMUNITY	Compliance to BS EN/EN61000-4-2,3,4,5,6,8,11, BS EN/EN61547, light industry level (surge immunity Line-Earth 4KV, Line-Line 2KV),EAC TP TC 020								
OTHERS	MTBF	1721.7K hrs min. Telcordia SR-332 (Bellcore) ; 146.9K hrs min. MIL-HDBK-217F (25°C)							
	DIMENSION	262*90*43.8mm (L*W*H)							
	PACKING	2Kg; 8pcs/17Kg/0.92CUFT							
NOTE	<ol style="list-style-type: none"> <li>All parameters NOT specially mentioned are measured at 347VAC input, rated current and 25°C of ambient temperature.</li> <li>Please refer to "DRIVING METHODS OF LED MODULE".</li> <li>De-rating may be needed under low input voltages. Please refer to "STATIC CHARACTERISTIC" sections for details.</li> <li>Length of set up time is measured at first cold start. Turning ON/OFF the power supply may lead to increase of the set up time.</li> <li>The driver is considered as a component that will be operated in combination with final equipment. Since EMC performance will be affected by the complete installation, the final equipment manufacturers must re-qualify EMC Directive on the complete installation again.</li> <li>This series meets the typical life expectancy of &gt;50,000 hours of operation when Tcase, particularly (Tc) point (or TMP, per DLC), is about 80°C or less.</li> <li>Please refer to the warranty statement on MEAN WELL's website at <a href="http://www.meanwell.com">http://www.meanwell.com</a>.</li> <li>The ambient temperature derating of 3.5°C/1000m with fanless models and of 5°C/1000m with fan models for operating altitude higher than 2000m(6500ft).</li> <li>For any application note and IP water proof function installation caution, please refer our user manual before using. <a href="https://www.meanwell.com/Upload/PDF/LED_EN.pdf">https://www.meanwell.com/Upload/PDF/LED_EN.pdf</a></li> <li>To fulfill requirements of the latest ErP regulation for lighting fixtures, this LED power supply can only be used behind a switch without permanently connected to the mains.</li> <li>The models certified by CCC (GB19510.14, GB19510.1, GB17743 and GB17625.1) are optional models. Please contact your MEAN WELL sales for more information.</li> </ol> <p>※ Product Liability Disclaimer : For detailed information, please refer to <a href="https://www.meanwell.com/serviceDisclaimer.aspx">https://www.meanwell.com/serviceDisclaimer.aspx</a></p>								

### Block Diagram

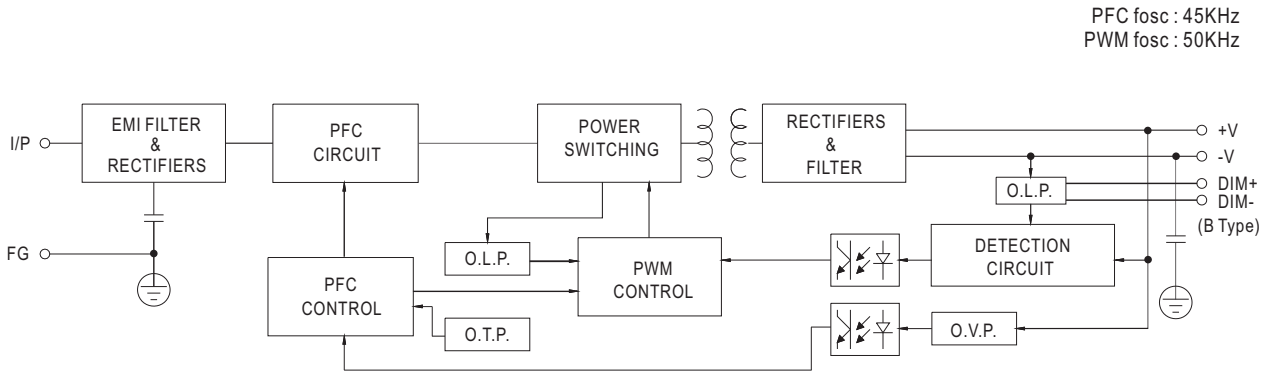

### DRIVING METHODS OF LED MODULE

※ This series works in constant current mode to directly drive the LEDs.

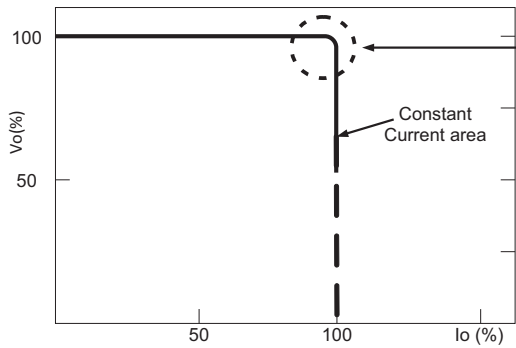

Typical output current normalized by rated current (%)

In the constant current region, the highest voltage at the output of the driver depends on the configuration of the end systems.  
Should there be any compatibility issues, please contact MEAN WELL.

**■ DIMMING OPERATION**

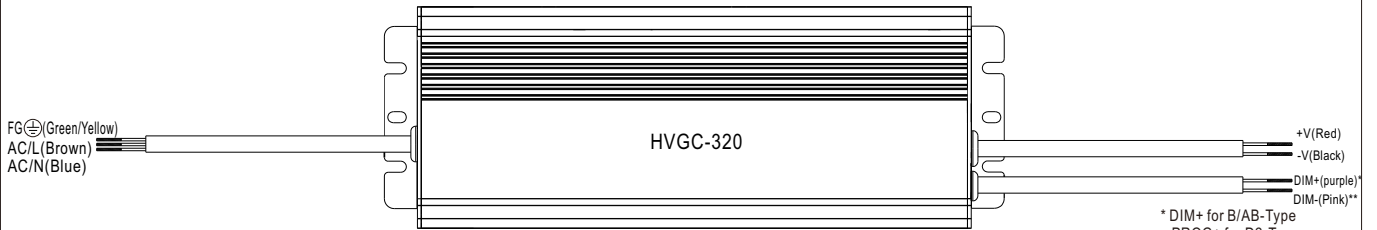

※ **3 in 1 dimming function (for B/AB-Type)**

- Output constant current level can be adjusted by applying one of the three methodologies between DIM+ and DIM-: 0 ~ 10VDC, or 10V PWM signal or resistance.
- Direct connecting to LEDs is suggested. It is not suitable to be used with additional drivers.
- Dimming source current from power supply: 100 $\mu$ A (typ.)

\* DIM+ for B/AB-Type  
PROG+ for D2-Type  
\* DIM- for B/AB-Type  
PROG- for D2-Type

◎ Applying additive 0 ~ 10VDC

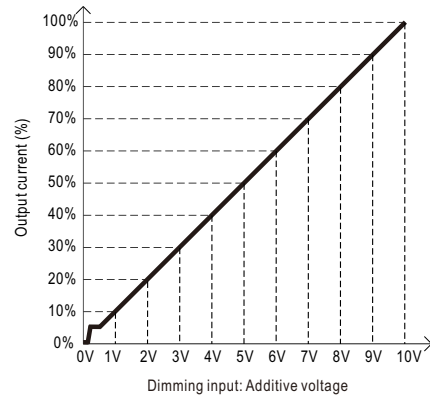
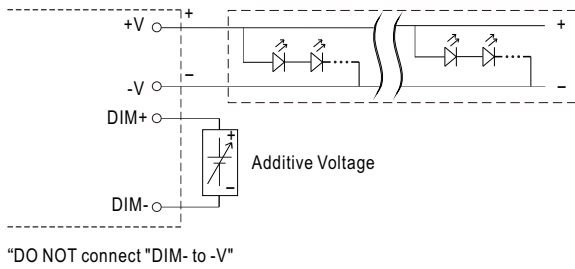

◎ Applying additive 10V PWM signal (frequency range 100Hz ~ 3KHz):

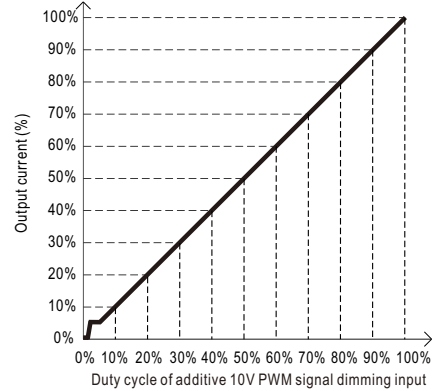
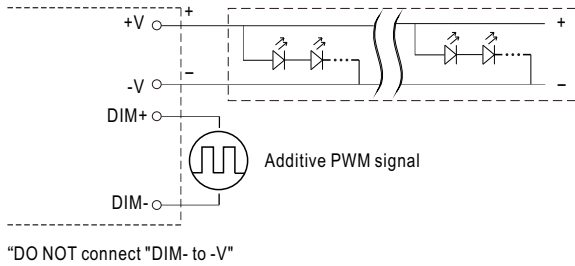

◎ Applying additive resistance:

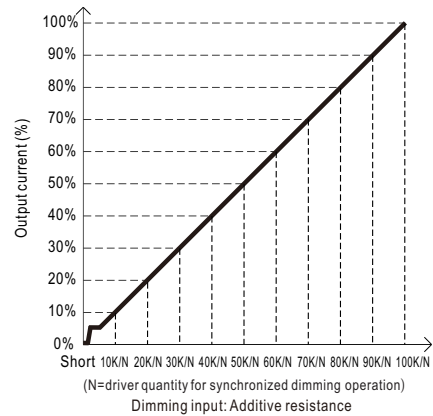
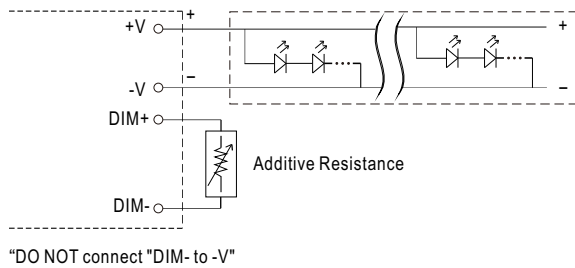

Note : 1. Min. dimming level is about 5% and the output current is not defined when 0% < I<sub>out</sub> < 5%.  
2. The output current could drop down to 0% when dimming input is about 0k $\Omega$  or 0Vdc, or 10V PWM signal with 0% duty cycle.

※ **Smart timer dimming function (for Dxx-Type by User definition)**

MEAN WELL Smart timer dimming primarily provides the adaptive proportion dimming profile for the output constant current level to perform up to 14 consecutive hours. 3 dimming profiles hereunder are defined accounting for the most frequently seen applications. If other options may be needed, please contact MEAN WELL for details.

Ex : ☉ D01-Type: the profile recommended for residential lighting

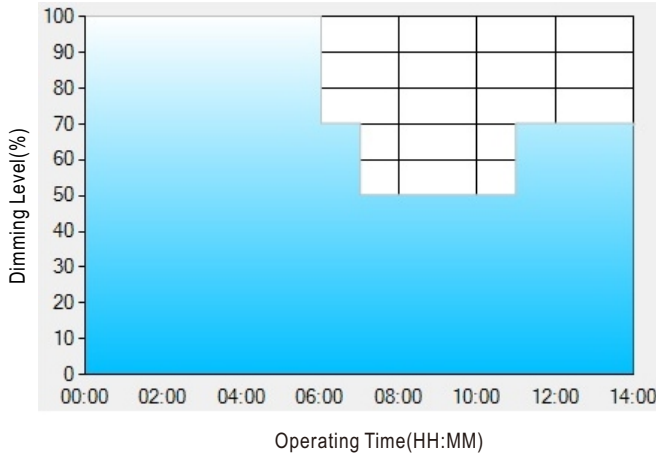

Set up for D01-Type in Smart timer dimming software program:

	T1	T2	T3	T4
TIME**	06:00	07:00	11:00	---
LEVEL**	100%	70%	50%	70%

\*\* : TIME matches Operating Time in the diagram whereas LEVEL matches Dimming Level.

Example: If a residential lighting application adopts D01-Type, when turning on the power supply at 6:00pm, for instance:

- [1] The power supply will switch to the constant current level at 100% starting from 6:00pm.
  - [2] The power supply will switch to the constant current level at 70% in turn, starting from 0:00am, which is 06:00 after the power supply turns on.
  - [3] The power supply will switch to the constant current level at 50% in turn, starting from 1:00am, which is 07:00 after the power supply turns on.
  - [4] The power supply will switch to the constant current level at 70% in turn, starting from 5:00am, which is 11:00 after the power supply turns on.
- The constant current level remains till 8:00am, which is 14:00 after the power supply turns on.

Ex : ☉ D02-Type: the profile recommended for street lighting

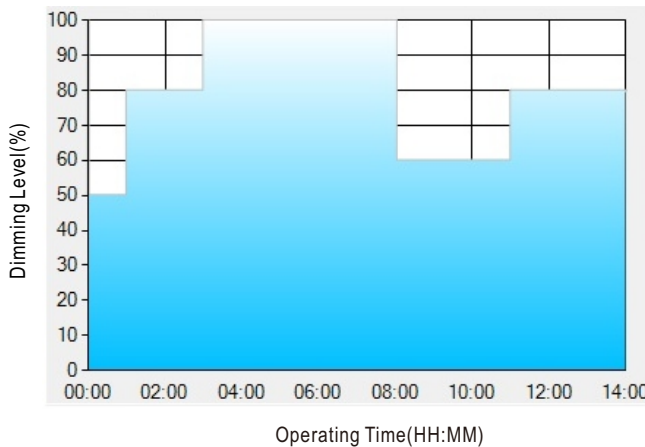

Set up for D02-Type in Smart timer dimming software program:

	T1	T2	T3	T4	T5
TIME**	01:00	03:00	8:00	11:00	---
LEVEL**	50%	80%	100%	60%	80%

\*\* : TIME matches Operating Time in the diagram whereas LEVEL matches Dimming Level.

Example: If a street lighting application adopts D02-Type, when turning on the power supply at 5:00pm, for instance:

- [1] The power supply will switch to the constant current level at 50% starting from 5:00pm.
- [2] The power supply will switch to the constant current level at 80% in turn, starting from 6:00pm, which is 01:00 after the power supply turns on.
- [3] The power supply will switch to the constant current level at 100% in turn, starting from 8:00pm, which is 03:00 after the power supply turns on.
- [4] The power supply will switch to the constant current level at 60% in turn, starting from 1:00am, which is 08:00 after the power supply turns on.
- [5] The power supply will switch to the constant current level at 80% in turn, starting from 4:00am, which is 11:00 after the power supply turns on. The constant current level remains till 6:30am, which is 14:00 after the power supply turns on.

Ex: © D03-Type: the profile recommended for tunnel lighting

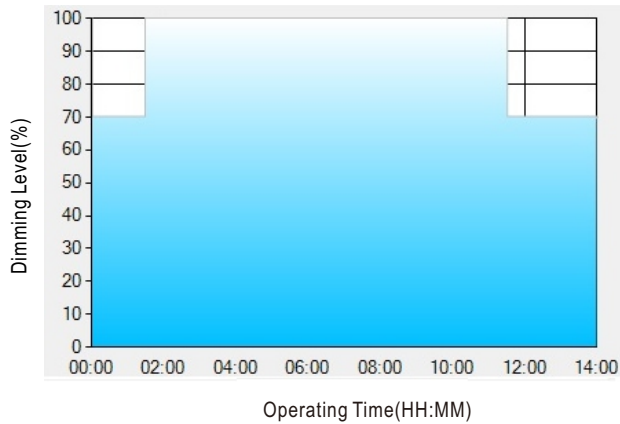

Set up for D03-Type in Smart timer dimming software program:

	T1	T2	T3
TIME**	01:30	11:00	---
LEVEL**	70%	100%	70%

\*\* : TIME matches Operating Time in the diagram whereas LEVEL matches Dimming Level.

Example: If a tunnel lighting application adopts D03-Type, when turning on the power supply at 4:30pm, for instance:

[1] The power supply will switch to the constant current level at 70% starting from 4:30pm.

[2] The power supply will switch to the constant current level at 100% in turn, starting from 6:00pm, which is 01:30 after the power supply turns on.

[3] The power supply will switch to the constant current level at 70% in turn, starting from 5:00am, which is 11:00 after the power supply turns on.

The constant current level remains till 6:30am, which is 14:00 after the power supply turns on.

### OUTPUT LOAD vs TEMPERATURE(Nota.7)

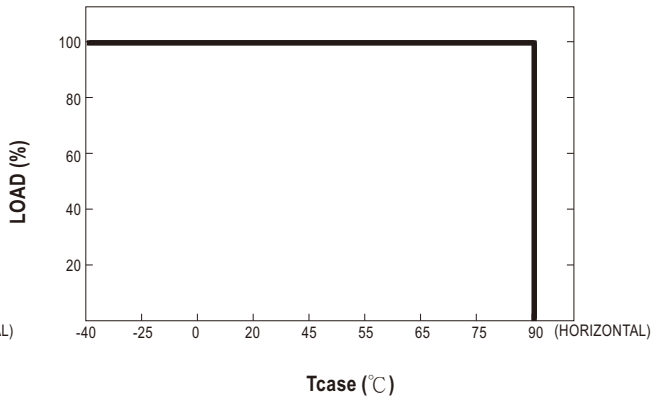
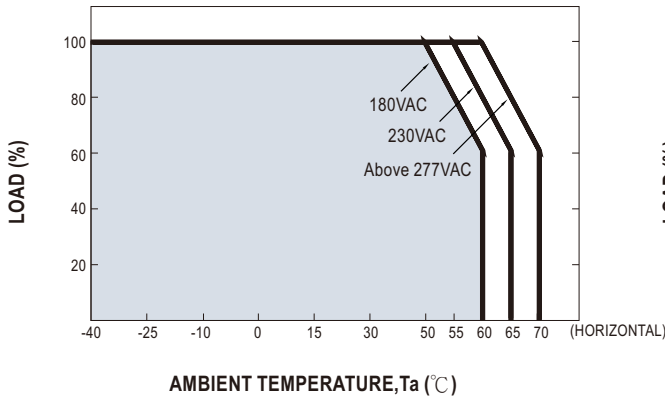

### STATIC CHARACTERISTIC

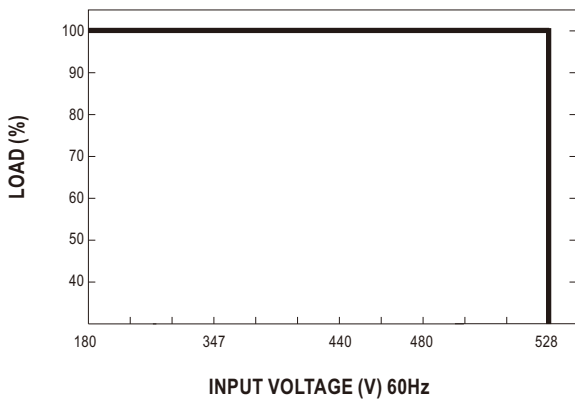

### POWER FACTOR (PF) CHARACTERISTIC

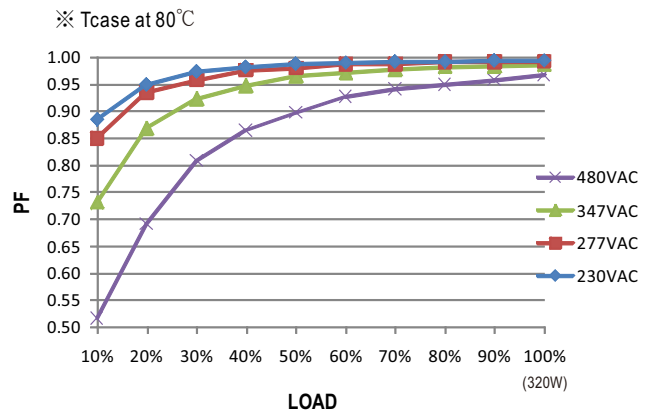

### TOTAL HARMONIC DISTORTION (THD)

※ 700mA Model, Tcase at 80°C

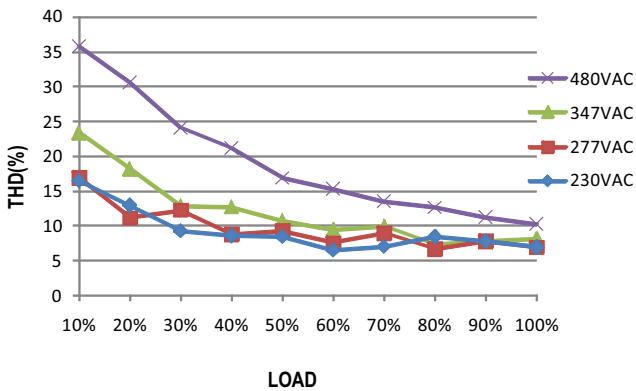

### EFFICIENCY vs LOAD

HVGC-320 series possess superior working efficiency that up to 93.5% can be reached in field applications.

※ 700mA Model, Tcase at 80°C

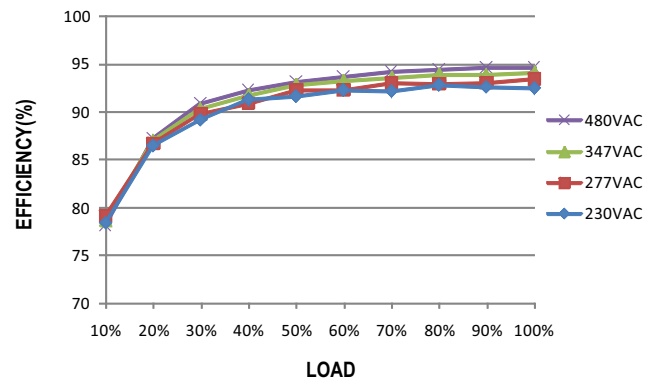

■ LIFE TIME

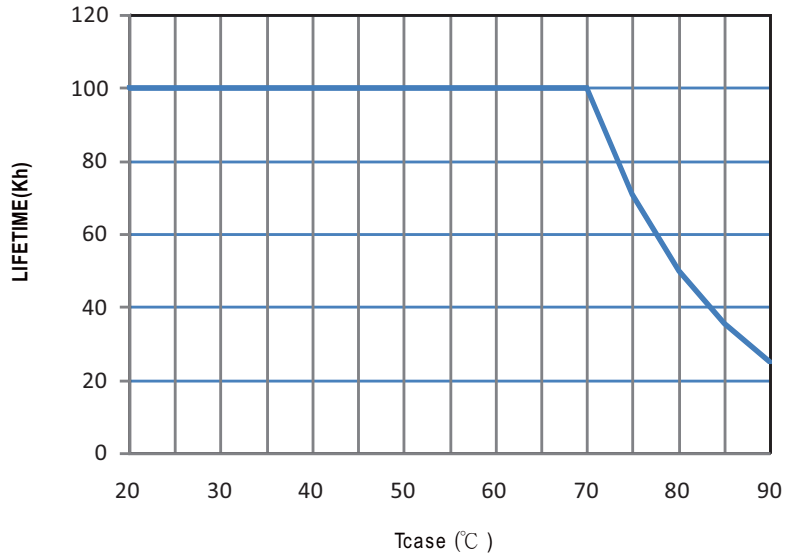



**MECHANICAL SPECIFICATION**

Case No. 228 Unit:mm

※ **A-Type**

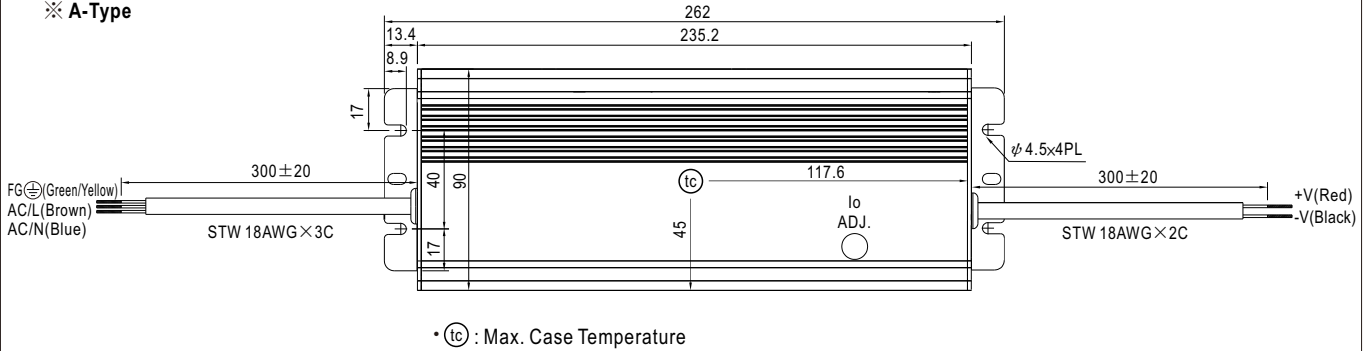

※ **AB-Type**

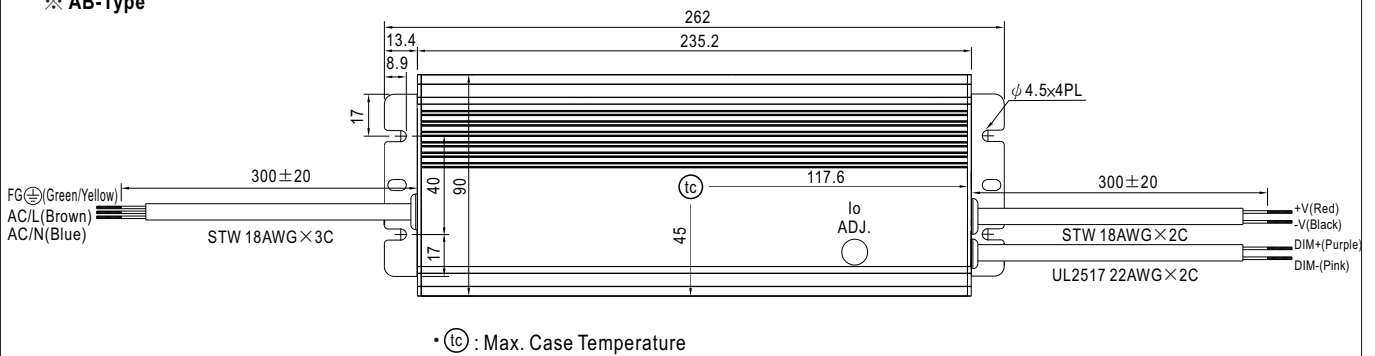

※ **B/D2-Type**

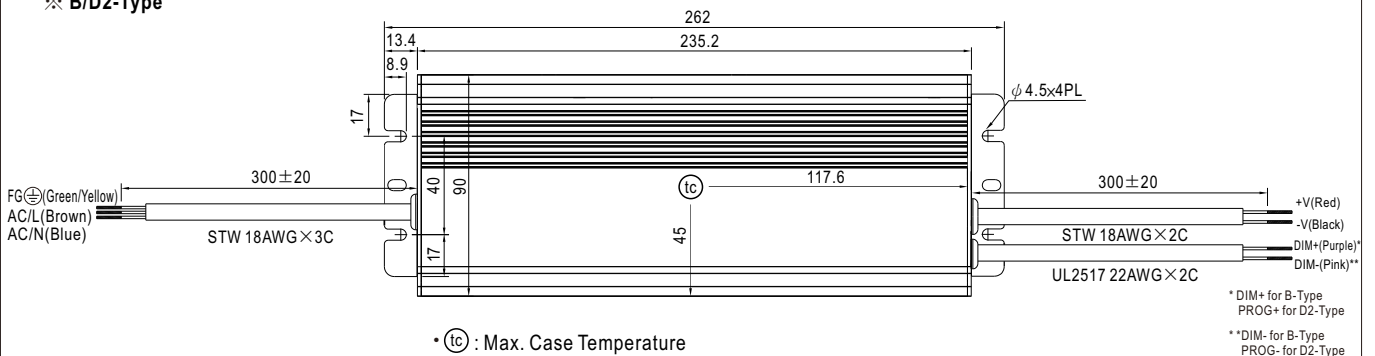

**INSTALLATION MANUAL**

Please refer to : <http://www.meanwell.com/manual.html>