

Rotary Encoder E6B2-C

New General-purpose Incremental Rotary Encoder

- A wide operating voltage range of 5 to 24 VDC (Open-collector Models).
- Resolution of 2,000 pulses/revolution in 40-mm housing.
- Phase Z can be adjusted with ease using the origin indicating function.
- A large load of 30 N in the radial direction and 20 N in the thrust direction is permitted.
- The load short-circuit and reversed connection protecting circuit assures highly reliable operation (except for line-driver outputs).



<READ AND UNDERSTAND THIS CATALOG>

Please read and understand this catalog before purchasing the products. Please consult your OMRON representative if you have any questions or comments.

Ordering Information

Power supply voltage	Output configuration	Resolution (P/R)	Model
5 to 24 VDC	NPN open-collector output	10/20/30/40/50/60/100/200/300/360/400/500/600/720/800/1,000/1,024/1,200/1,500/1,800/2,000	E6B2-CWZ6C
12 to 24 VDC	PNP open-collector output	100/200/360/500/600/1,000/2,000	E6B2-CWZ5B
5 to 12 VDC	Voltage output	10/20/30/40/50/60/100/200/300/360/400/500/600/1,000/1,200/1,500/1,800/2,000	E6B2-CWZ3E
5 VDC	Line driver output	10/20/30/40/50/60/100/200/300/360/400/500/600/1,000/1,024/1,200/1,500/1,800/2,000	E6B2-CWZ1X

Note: When ordering, specify the resolution in addition to the model number (example: E6B2-CWZ6C 100P/R).

Accessories (Order Separately)

Name	Model	Remarks
Coupling	E69-C06B	Provided with the product.
	E69-C68B	Different end diameter
	E69-C610B	Different end diameter
	E69-C06M	Metal construction
Flange	E69-FBA	---
	E69-FBA02	E69-2 Servo Mounting Bracket provided.
Servo Mounting Bracket	E69-2	---

Application Example

Filling Control

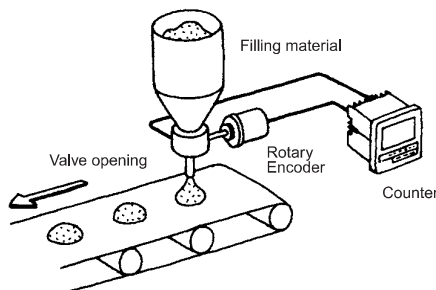

Specifications

■ Ratings/Characteristics

Item	E6B2-CWZ6C	E6B2-CWZ5B	E6B2-CWZ3E	E6B2-CWZ1X
Power supply voltage	5 VDC -5% to 24 VDC +15%, Ripple (p-p): 5% max.	12 VDC -10% to 24 VDC +15%, Ripple (p-p): 5% max.	5 VDC -5% to 12 VDC +10%, Ripple (p-p): 5% max.	5 VDC ±5%, Ripple (p-p): 5% max.
Current consumption (See note 1.)	70 mA max.	80 mA max.		130 mA max.
Resolution (pulses/rotation)	10/20/30/40/50/60/100/200/300/ 360/400/500/600/720/800/1,000/ 1,024/1,200/1,500/1,800/2,000 P/R	100/200/360/500/600/ 1,000/2,000 P/R	10/20/30/40/50/60/100/200/300/ 360/400/500/600/1,000/1,200/ 1,500/1,800/2,000 P/R	10/20/30/40/50/60/100/200/ 300/360/400/500/600/1,000/ 1,024/1,200/1,500/1,800/ 2,000 P/R
Output phases	A, B, and Z			A, \bar{A} , B, \bar{B} , Z, \bar{Z}
Output configuration	NPN open-collector output	PNP open-collector output	Voltage output (NPN output)	Line driver output (See note 2.)
Output capacity	Applied voltage: 30 VDC max. Sink current: 35 mA max. Residual voltage: 0.4 V max. (at sink current of 35 mA)	Applied voltage: 30 VDC max. Source current: 35 mA max. Residual voltage: 0.4 V max. (at source current of 35 mA)	Output resistance: 2 k Ω Sink current: 20 mA max. Residual voltage: 0.4 V max. (at sink current of 20 mA)	AM26LS31 equivalent Output current: High level = $I_o = -20$ mA Low level = $I_s = 20$ mA Output voltage: High level = $V_o = 2.5$ V min. Low level = $V_s = 0.5$ V max.
Max. response speed (See note 3.)	100 kHz	50 kHz	100 kHz	
Phase difference on output	90°±45° between A and B (1/4T±1/8T)			
Rise and fall times of output	1 μ s max. (Control output voltage: 5 V; load resistance: 1 k Ω ; cable length: 2 m)	1 μ s max. (Cable length: 2 m; source current: 10 mA max.)	1 μ s max. (Cable length: 2 m; sink current: 10 mA max.)	0.1 μ s max. (Cable length: 2 m; $I_o = -20$ mA; $I_s = 20$ mA)
Starting torque	0.98 m N·m max.			
Moment of inertia	1 x 10 ⁻⁶ kg·m ² max.; 3 x 10 ⁻⁷ kg·m ² max. at 600 P/R max.			
Shaft loading	Radial	30 N		
	Thrust	20 N		
Max. permissible speed	6,000 r/min.			
Protection circuits	Power supply reverse polarity protection, Output load short-circuit protection			---
Ambient temperature	Operating: -10°C to 70°C (with no icing) Storage: -25°C to 85°C (with no icing)			
Ambient humidity	Operating/storage: 35% to 85% (with no condensation)			
Insulation resistance	20 M Ω min. (at 500 VDC) between current-carrying parts and case			
Dielectric strength	500 VAC, 50/60 Hz for 1 min between current-carrying parts and case			
Vibration resistance	10 to 500 Hz, 150 m/s ² or 2-mm double amplitude for 11 min 3 times each in X, Y, and Z directions			
Shock resistance	1,000 m/s ² 3 times each in X, Y, and Z directions			
Degree of protection	IEC 60529: IP50			
Connection method	Pre-wired Models (standard length: 0.5 m)			
Weight (packed state)	Approx. 100 g			
Accessories	Coupling, Hexagonal Wrench, Instruction Manual			

Note 1. An inrush current of approximately 9 A will flow for approximately 0.3 ms when the power is turned ON.

- The line driver output is a data transmission circuit compatible with RS-422A and long-distance transmission is possible with a twisted-pair cable.
- The maximum electrical response speed is determined by the resolution and maximum response speed as follows:
Maximum electrical response speed (rpm) = Maximum response speed/resolution x 60
This means that the E6B2-C Rotary Encoder will not operate electrically if its speed exceeds the maximum electrical response speed.

Operation

Output Circuits

E6B2-CWZ6C

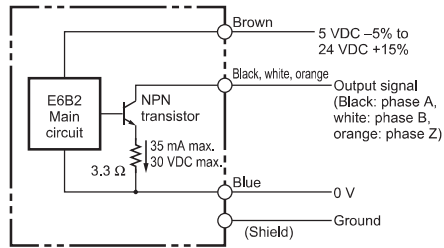

E6B2-CWZ5B

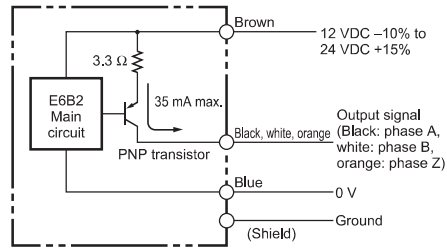

E6B2-CWZ3E

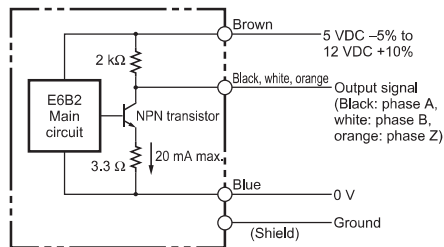

E6B2-CWZ1X

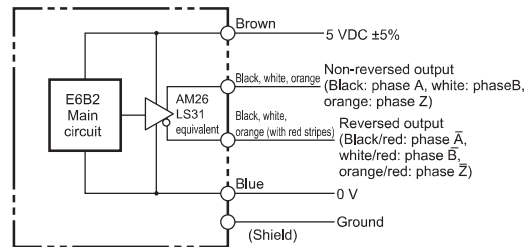

Connection

Be sure to connect the external terminals correctly or the E6B2-C Rotary Encoder may be damaged.

E6B2-CWZ6C/-CWZ5B/-CWZ3E

Color	Terminal
Brown	Power supply (+V _{CC})
Black	Output phase A
White	Output phase B
Orange	Output phase Z
Blue	0 V (common)

E6B2-CWZ1X

Color	Terminal
Brown	Power supply (+V _{CC})
Black	Output phase A
White	Output phase B
Orange	Output phase Z
Black/red stripes	Output phase \bar{A}
White/red stripes	Output phase \bar{B}
Orange/red stripes	Output phase \bar{Z}
Blue	0 V (common)

Note: Receiver: AM26LS32 equivalent

- Note 1.** The shielded cable outer core is not connected to the inner area or the case.
- 2.** The phase-A, phase-B, and phase-Z circuits are all identical.
- 3.** Normally, connect GND to 0 V or to an external ground.

■ Timing Charts

Open-collector Output

E6B2-CWZ6C

E6B2-CWZ5B

Direction or resolution: CW
(As viewed from the end of the shaft)

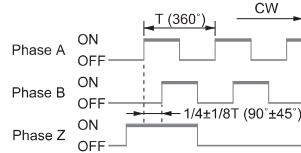

Note: Phase A is $1/4 \pm 1/8 T$ faster than phase B.
(The ONs in the above timing chart mean that the output transistor is ON and the OFFs mean that the output transistor OFF.)

Direction or resolution: CCW
(As viewed from the end of the shaft)

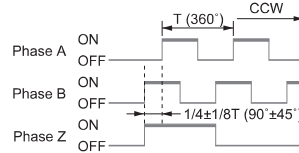

Note: Phase A is $1/4 \pm 1/8 T$ slower than phase B.

Voltage Output

E6B2-CWZ3E

Direction or resolution: CW
(As viewed from the end of the shaft)

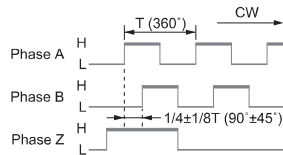

Note: Phase A is $1/4 \pm 1/8 T$ faster than phase B.

Direction or resolution: CCW
(As viewed from the end of the shaft)

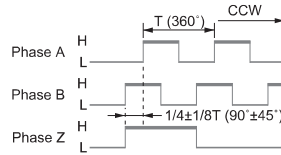

Note: Phase A is $1/4 \pm 1/8 T$ slower than phase B.

Line Driver Output

E6B2-CWZ1X

Direction or resolution: CW
(As viewed from the end of the shaft)

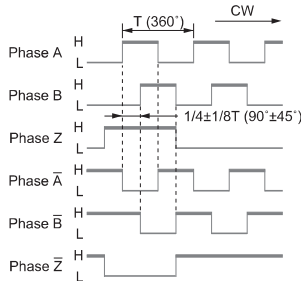

Direction or resolution: CCW
(As viewed from the end of the shaft)

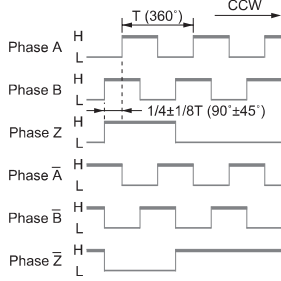

Connection Examples

Connection to H7CR-CW Counter

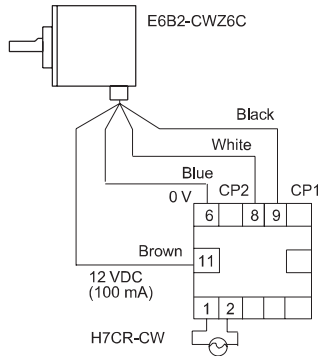

Features of H7CR

DIN-sized (DIN 48) counter incorporating a prescale function converting the measured value to the actual value.
Synchronized output and \pm indication are available (\pm area models).
Models with a general-purpose six-digit display and four-digit display are available.

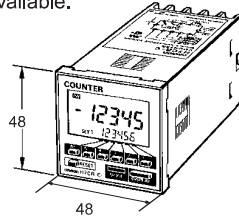

Connection to K3NR-NB□□□/K3NP-NB□□□ Rotary Intelligent Signal Processor

Features of K3NR/K3NP

Each model incorporates a prescale function with an input range of 50 kHz and the measurement accuracy is 0.006%.
A variety of outputs, including relay, transistor, BCD, linear, and communications outputs, are available.

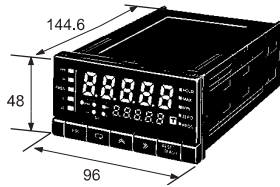

Connections with Peripheral Devices

Coupling	Specification	Resin, standard				Resin, non-standard opening diameter		Metal	
		4 (H8), 13	6 (H8), 15	8 (H8), 19	10 (H8), 22	6/8 (H8), 19	6/10 (H8), 22	6 (H8), 19.1	10 (H8), 25.4
Rotary Encoder	Model	E69-C04B	E69-C06B	E69-C08B	E69-C10B	E69-C68B	E69-C610B	E69-C06M	E69-C10M
E6B2, 6-mm diameter		C	A	C	C	B	B	B	C

Note: A: Possible to connect directly in most cases.
B: Possible to connect, but an independent power supply or pull-up resistor will be required.
C: Impossible to connect.

Precautions

⚠ WARNING

This product is not designed or rated for ensuring safety of persons.
Do not use it for such purposes.



■ Precautions for Safe Use

Incorrect wiring may damage internal circuits.

■ Precautions for Correct Use

Do not use the Encoder under ambient conditions that exceed the ratings.

Input to More than One Counter from Encoder (with Voltage Output)

Use the following formula to obtain the number of counters to be connected to a single E6B2-C Rotary Encoder.

$$\text{Number of counters (N)} = \frac{R1 (E-V)}{V \times R2}$$

- E: Voltage supplied to Rotary Encoder
- V: Minimum input voltage of the counter
- R2: Output resistance of the Rotary Encoder
- R1: Input resistance of the counter

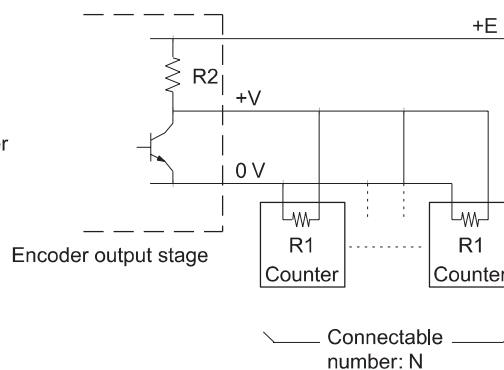

Origin Indication

It is easy to adjust the position of phase Z with the origin indication function. The following illustration (on the left-hand side) shows the relationship between phase Z and the origin. Set cut face D to the origin as shown in the illustration (on the right-hand side).

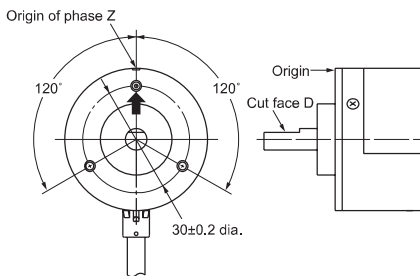

Mounting

Mounting Procedure

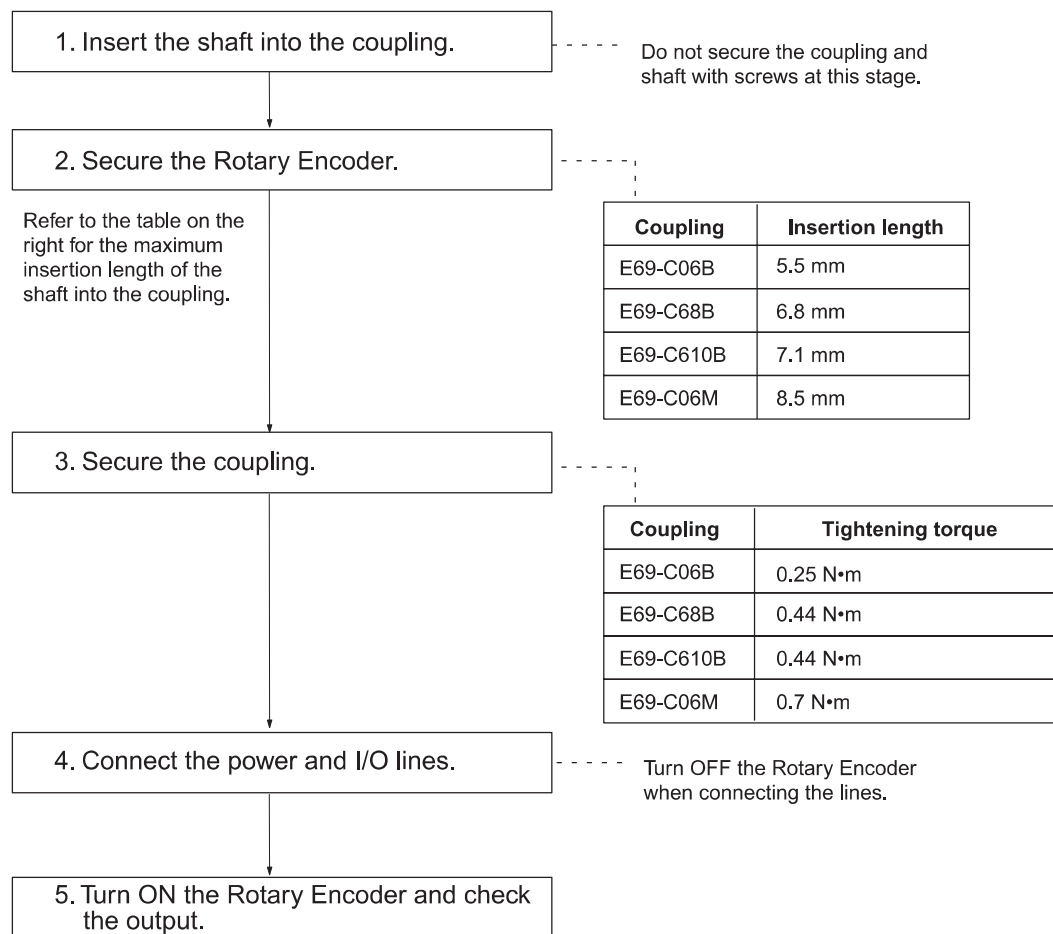

Installation

Be careful not to spray water or oil onto the E6B2-C Rotary Encoder.

The E6B2-C Rotary Encoder consists of high-precision components. Handle it with utmost care and do not drop the Rotary Encoder, otherwise malfunctioning may result.

When the E6B2-C Rotary Encoder is used in reversing operation, pay utmost attention to the mounting direction of the E6B2-C Rotary Encoder and the directions of increment and decrement rotation.

To match phase Z of the E6B2-C Rotary Encoder and the origin of the device to be connected to the E6B2-C Rotary Encoder, confirm the phase Z output when connecting the device.

Do not impose an excessive load on the shaft if the shaft is connected to a gear.

If the Rotary Encoder is mounted with screws, the tightening torque must be approximately 0.49 N•m.

Refer to the following illustrations when using a standard coupling.

Eccentricity tolerance	
Declination tolerance	
Displacement tolerance in the shaft direction	

If the eccentricity or declination value exceeds the tolerance, an excessive load imposed on the shaft may damage the Rotary Encoder or shorten the life of the Rotary Encoder.

Mounting

When connecting the shaft of the Rotary Encoder with a chain timing belt or gear, connect the chain timing belt or gear with the shaft via the bearing and coupling as shown in the following illustration.

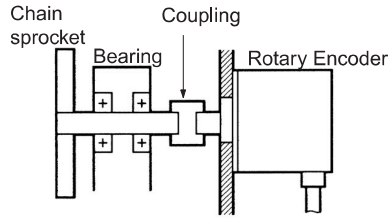

Do not hit the shaft or coupling with a hammer when inserting the shaft into the coupling. No shock must be applied to the shaft or coupling.

When connecting or disconnecting the coupling, do not bend, press, or pull the coupling excessively.

Bearing Life

The following graph shows the life expectancy (theoretical values) of the bearing with radial and thrust loads imposed on the bearing.

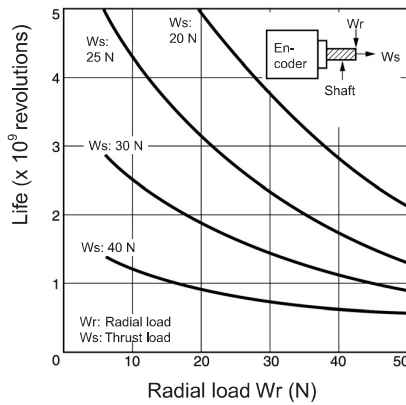

Wiring

If the Rotary Encoder is mounted in a panel, do not pull the cable with more than a force of 29.4 N.

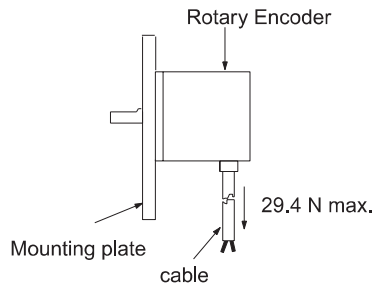

Do not pull the cable of the E6B2-C rotary Encoder after the E6B2-C Rotary Encoder is mounted to a panel. Do not apply any shock to the hollow shaft or the body.

Connections

When extending the cable, select the kind of cable with care, taking the response speed into consideration. The longer the cable is, the more the residual voltage increases due to the resistance of the cable and the capacitance between the wires. As a result, the waveform will be distorted.

OMRON recommends models with a line driver output if the cable needs to be extended.

To reduce inductive noise, the cable must be laid the shortest distance, especially when the signal is input to an IC.

Insert a surge absorber between the power supply terminals if there is any surge.

To reduce noise, the total cable length must be as short as possible.

Incorrect pulses may be generated when the E6B2-C Rotary Encoder is turned ON or OFF. Do not use the connected device for 0.1 s after the E6B2-C Rotary Encoder is turned ON and for 0.1 s before the E6B2-C Rotary Encoder is turned OFF.

Cable Extension

The rise time of each output waveform will increase when the cable is extended. This will affect the phase difference characteristics of phases A and B.

The rise time varies with the resistance of the cable, the kind of cable, and the length of the cable.

The residual output voltage will increase according to the length of the cable.

E6B2-CWZ6C

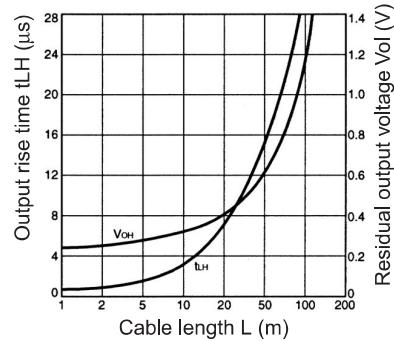

Measurement example

Power supply voltage: 5 VDC

Load resistance: 1 kΩ

(Residual output voltage was measured at a load current of 35 mA.)

Cable: Dedicated cable

Preventing Miscounting

If the operation of the E6B2-C Rotary Encoder is stopped near a signal rising or falling edge, incorrect pulses may be generated, in which case the E6B2-C Rotary Encoder will miscount. Use an increment-decrement counter to prevent miscounting.

Extension of Line Driver Output

Use twisted-pair cable to extend the line driver cable.

Recommended cable: Tachii Densen's TKVVS4P-02A

Use an RS-422A receiver.

The twisted-pair wires shown in the following illustration are suitable for RS-422A signal transmission. Normal mode noise can be eliminated by twisting the wires because the generated electrical forces on the lines cancel each other.

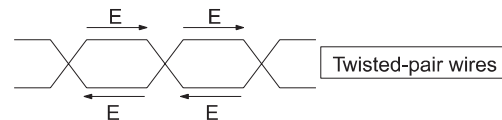

Check that the E6B2-C is supplied with 5 VDC when a line driver output is used. There will be an approximately 1 V voltage drop if the cable length is 100 m.

Using a Line Receiver IC

Recommended IC: Texas Instruments

AM26LS32, AM26C32

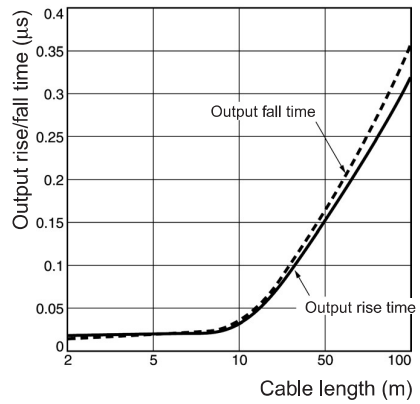

Others

Input to More than One Counter from Rotary Encoder (with Voltage Output)

Use the following formula to obtain the number of counters to be connected to a single E6B2-C Rotary Encoder.

$$\text{Connectable number of counters (N)} = \frac{R1(E-V)}{V \cdot R2}$$

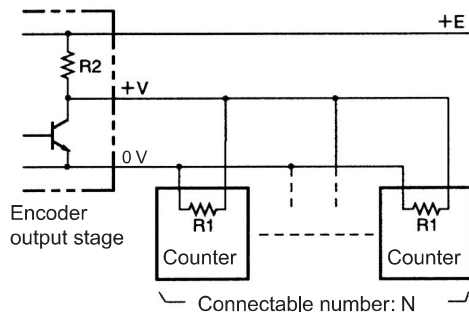

- E: Voltage supplied to Rotary Encoder
- V: Minimum input voltage of the counter
- R1: Input resistance of the counter
- R2: Output resistance of the Rotary Encoder

Dimensions

Note: All units are in millimeters unless otherwise indicated.

E6B2-C

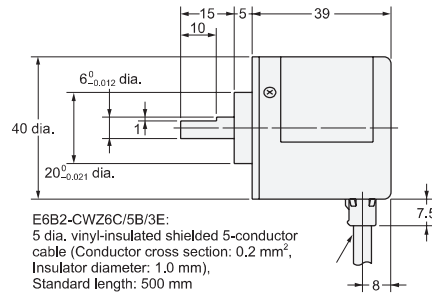
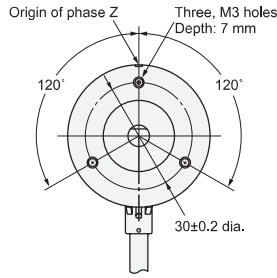
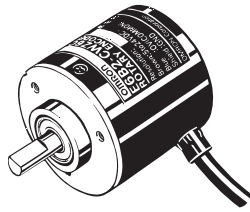

Couplings E69-C06B (Provided)

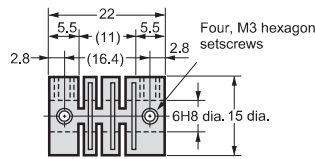

Material: Glass-reinforced PBT

E69-C68B (Order Separately, Different End Diameter)

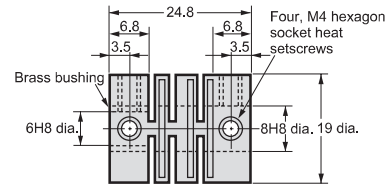

Material: Glass-reinforced PBT

E69-C610B (Order Separately, Different End Diameter)

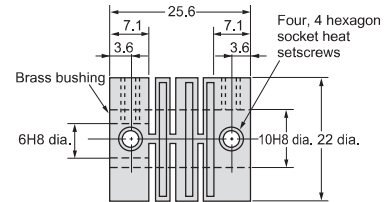

Material: Glass-reinforced PBT

E69-C06M (Order Separately, Different End Diameter)

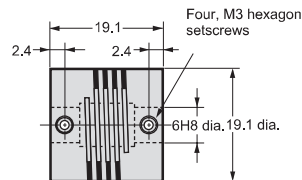

Material: Extra super duralumin

Flanges (Order Separately) E69-FBA

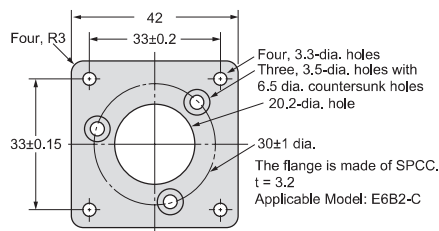

E69-FBA02

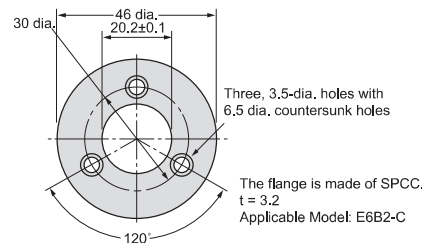

Mounting Bracket (Three Brackets in a set; Provided with the E69-FBA02) E69-2

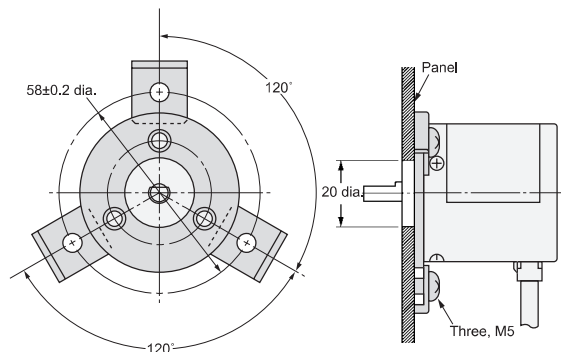
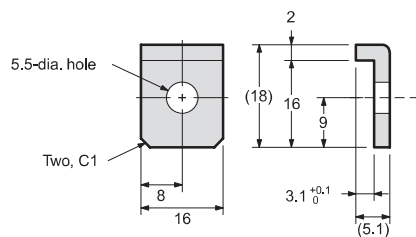

READ AND UNDERSTAND THIS DOCUMENT

Please read and understand this document before using the products. Please consult your OMRON representative if you have any questions or comments.

WARRANTY

OMRON's exclusive warranty is that the products are free from defects in materials and workmanship for a period of one year (or other period if specified) from date of sale by OMRON.

OMRON MAKES NO WARRANTY OR REPRESENTATION, EXPRESS OR IMPLIED, REGARDING NON-INFRINGEMENT, MERCHANTABILITY, OR FITNESS FOR PARTICULAR PURPOSE OF THE PRODUCTS. ANY BUYER OR USER ACKNOWLEDGES THAT THE BUYER OR USER ALONE HAS DETERMINED THAT THE PRODUCTS WILL SUITABLY MEET THE REQUIREMENTS OF THEIR INTENDED USE. OMRON DISCLAIMS ALL OTHER WARRANTIES, EXPRESS OR IMPLIED.

LIMITATIONS OF LIABILITY

OMRON SHALL NOT BE RESPONSIBLE FOR SPECIAL, INDIRECT, OR CONSEQUENTIAL DAMAGES, LOSS OF PROFITS OR COMMERCIAL LOSS IN ANY WAY CONNECTED WITH THE PRODUCTS, WHETHER SUCH CLAIM IS BASED ON CONTRACT, WARRANTY, NEGLIGENCE, OR STRICT LIABILITY.

In no event shall responsibility of OMRON for any act exceed the individual price of the product on which liability is asserted.

IN NO EVENT SHALL OMRON BE RESPONSIBLE FOR WARRANTY, REPAIR, OR OTHER CLAIMS REGARDING THE PRODUCTS UNLESS OMRON'S ANALYSIS CONFIRMS THAT THE PRODUCTS WERE PROPERLY HANDLED, STORED, INSTALLED, AND MAINTAINED AND NOT SUBJECT TO CONTAMINATION, ABUSE, MISUSE, OR INAPPROPRIATE MODIFICATION OR REPAIR.

SUITABILITY FOR USE

THE PRODUCTS CONTAINED IN THIS DOCUMENT ARE NOT SAFETY RATED. THEY ARE NOT DESIGNED OR RATED FOR ENSURING SAFETY OF PERSONS, AND SHOULD NOT BE RELIED UPON AS A SAFETY COMPONENT OR PROTECTIVE DEVICE FOR SUCH PURPOSES. Please refer to separate catalogs for OMRON's safety rated products.

OMRON shall not be responsible for conformity with any standards, codes, or regulations that apply to the combination of products in the customer's application or use of the product.

At the customer's request, OMRON will provide applicable third party certification documents identifying ratings and limitations of use that apply to the products. This information by itself is not sufficient for a complete determination of the suitability of the products in combination with the end product, machine, system, or other application or use.

The following are some examples of applications for which particular attention must be given. This is not intended to be an exhaustive list of all possible uses of the products, nor is it intended to imply that the uses listed may be suitable for the products:

- Outdoor use, uses involving potential chemical contamination or electrical interference, or conditions or uses not described in this document.
- Nuclear energy control systems, combustion systems, railroad systems, aviation systems, medical equipment, amusement machines, vehicles, safety equipment, and installations subject to separate industry or government regulations.
- Systems, machines, and equipment that could present a risk to life or property.

Please know and observe all prohibitions of use applicable to the products.

NEVER USE THE PRODUCTS FOR AN APPLICATION INVOLVING SERIOUS RISK TO LIFE OR PROPERTY WITHOUT ENSURING THAT THE SYSTEM AS A WHOLE HAS BEEN DESIGNED TO ADDRESS THE RISKS, AND THAT THE OMRON PRODUCT IS PROPERLY RATED AND INSTALLED FOR THE INTENDED USE WITHIN THE OVERALL EQUIPMENT OR SYSTEM.

PERFORMANCE DATA

Performance data given in this document is provided as a guide for the user in determining suitability and does not constitute a warranty. It may represent the result of OMRON's test conditions, and the users must correlate it to actual application requirements. Actual performance is subject to the OMRON Warranty and Limitations of Liability.

CHANGE IN SPECIFICATIONS

Product specifications and accessories may be changed at any time based on improvements and other reasons.

It is our practice to change model numbers when published ratings or features are changed, or when significant construction changes are made. However, some specifications of the product may be changed without any notice. When in doubt, special model numbers may be assigned to fix or establish key specifications for your application on your request. Please consult with your OMRON representative at any time to confirm actual specifications of purchased products.

DIMENSIONS AND WEIGHTS

Dimensions and weights are nominal and are not to be used for manufacturing purposes, even when tolerances are shown.

ERRORS AND OMISSIONS

The information in this document has been carefully checked and is believed to be accurate; however, no responsibility is assumed for clerical, typographical, or proofreading errors, or omissions.

PROGRAMMABLE PRODUCTS

OMRON shall not be responsible for the user's programming of a programmable product, or any consequence thereof.

COPYRIGHT AND COPY PERMISSION

This document shall not be copied for sales or promotions without permission.

This document is protected by copyright and is intended solely for use in conjunction with the product. Please notify us before copying or reproducing this document in any manner, for any other purpose. If copying or transmitting this document to another, please copy or transmit it in its entirety.

ALL DIMENSIONS SHOWN ARE IN MILLIMETERS.
To convert millimeters into inches, multiply by 0.03937. To convert grams into ounces, multiply by 0.03527.

Cat. No. Q085-E1-03A

In the interest of product improvement, specifications are subject to change without notice.

OMRON Corporation

Industrial Automation Company

Sensing Devices Division H.Q.

Industrial Sensors Division

Shiokoji Horikawa, Shimogyo-ku,

Kyoto, 600-8530 Japan

Tel: (81)75-344-7022/Fax: (81)75-344-7107

0306 (1092)