

Product Data Sheet

8315100166

VWCF080KKFLS

AF80-00166 48V P/2U

13.200

**ebmpapst**

engineering a better life



AF80-00166 48V P/2U 13.200

INDEX

- 1 General ..... 3**
- 2 Mechanics ..... 3**
  - 2.1 General ..... 3
  - 2.2 Connections ..... 3
- 3 Operating Data ..... 5**
  - 3.1 Electrical Interface - Input ..... 5
  - 3.2 Electrical Operating Data ..... 6
  - 3.3 Electrical Interface - Output ..... 7
  - 3.4 Electrical Features ..... 8
  - 3.5 Aerodynamics ..... 9
  - 3.6 Sound Data ..... 10
- 4 Environment ..... 10**
  - 4.1 General ..... 10
  - 4.2 Climatic Requirements ..... 11
  - 4.3 EMC ..... 11
- 5 Safety ..... 12**
  - 5.1 Electrical Safety ..... 12
  - 5.2 Approval Tests ..... 12
- 6 Reliability ..... 12**
  - 6.1 General ..... 12

**1 General**

Fan type	Axial	
Rotating direction looking at rotor	Counterclockwise	
Airflow direction	Air outlet over struts	
Bearing system	Ball bearing	
Mounting position - shaft	Any	

**2 Mechanics****2.1 General**

Width	80,0 mm	
Height	80,0 mm	
Depth	38,0 mm	
Mass	0,220 kg	
Housing material	Plastic	
Impeller material	Plastic	
Max. torque when mounted across both mounting flanges	Wire outlet corner: 50 Ncm Remaining corners: 110 Ncm	
Screw size	ISO 4762 - M4 degreased, without an additional brace and without washer	

**2.2 Connections**

Electrical connection	Wires	
Lead wire length	L = 310 mm	
Tolerance	+ - 10,0 mm	
Wire size (AWG)	22	
Insulation diameter	1,70 mm	

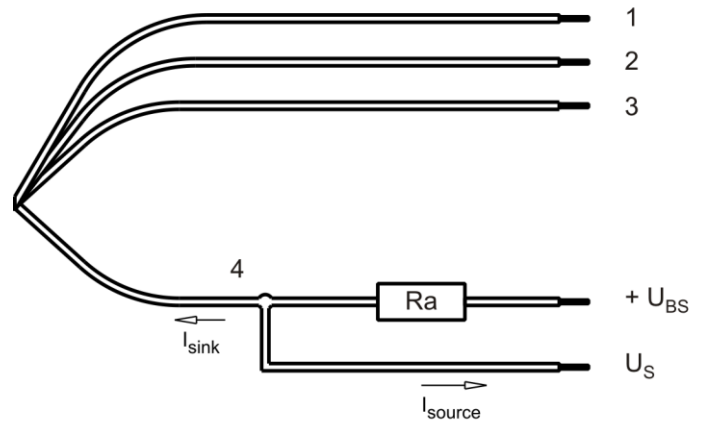

Wire	Color	Operation	Wire size	Insulation diameter
1	red	+ UB	AWG 22	1,70 mm
2	blue	- GND	AWG 22	1,70 mm
3	violet	PWM	AWG 22	1,70 mm
4	white	Tacho	AWG 22	1,70 mm

The auxiliaries shown on the schematic diagram (which are required for the intended use) are not part of our delivery.

3 Operating Data

3.1 Electrical Interface - Input

Control input	PWM
---------------	-----

Features

Input type	Open collector	
PWM - Frequency		1 kHz - 10 kHz typical: 2 kHz

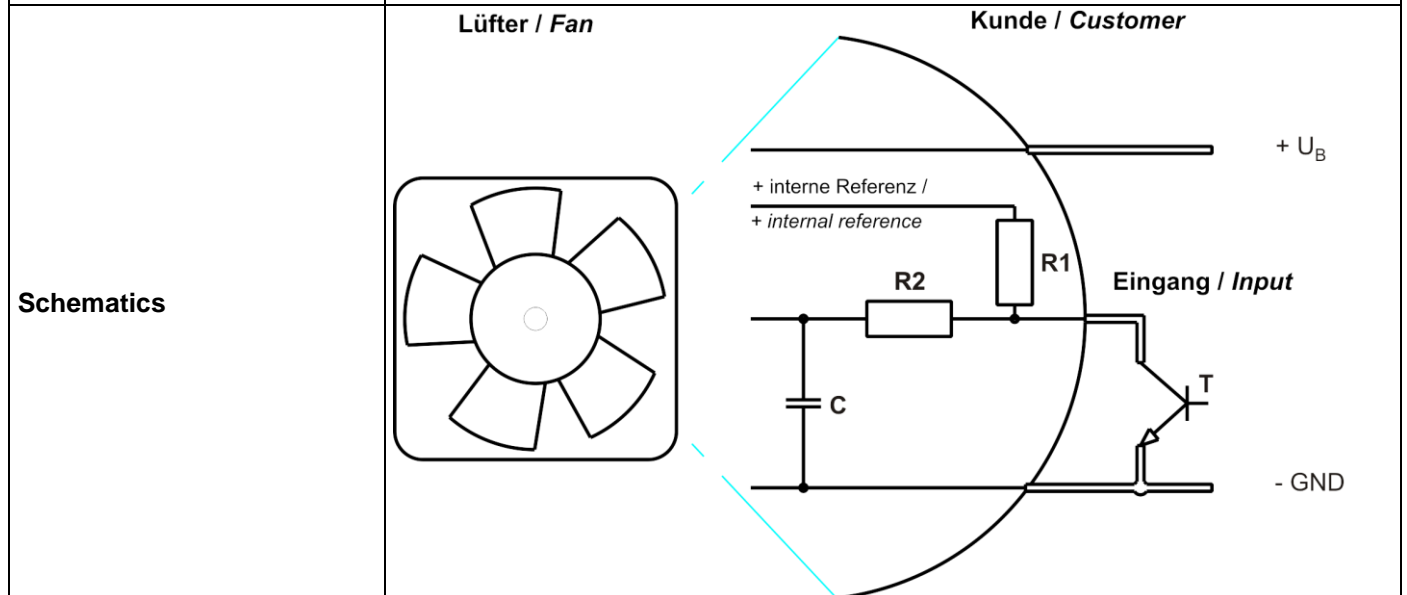
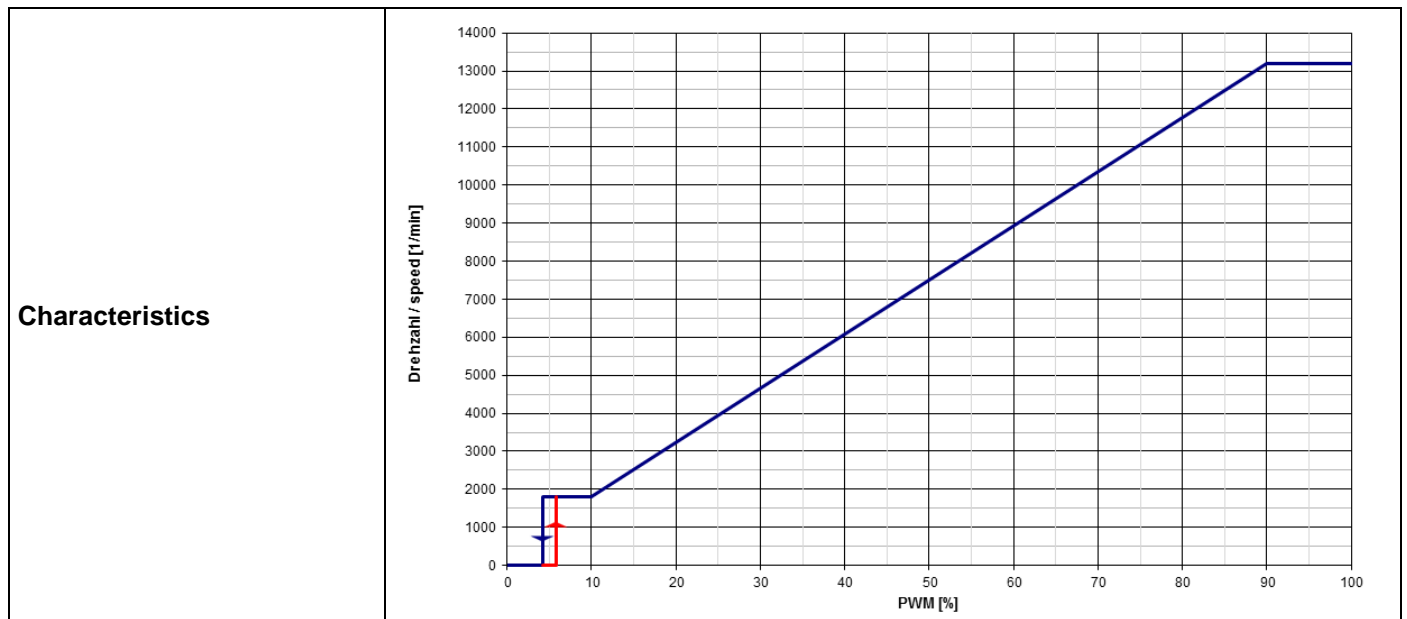

Speed controll: 0... 100 %, PWM-Low < 0,2 V

## 3.2 Electrical Operating Data

Measurement conditions: Normal air density = 1,2 kg/m<sup>3</sup>; Temperature 23°C +/- 3°C; Motor axis horizontal; warm-up time before measuring 5 minutes (unless otherwise specified). In the intake and outlet area should not be any solid obstruction within 0,5 m.

$\Delta p = 0$ : corresp. to free air flow (see chapter aerodynamics)  
I: corresp. to arithm. mean current value

Name	Condition
PWM 0001	PWM: 100 %; f: 2 kHz

Features	Condition	Symbol	Values		
Voltage range		U	36 V		60 V
Nominal voltage		U <sub>N</sub>		48 V	
Power consumption	$\Delta p = 0$	P	25 W	25 W	25 W
Tolerance	PWM 0010		+/- 17,5 %	+/- 17,5 %	+/- 17,5 %
Current consumption	$\Delta p = 0$	I	700 mA	520 mA	430 mA
Tolerance	PWM 0010		+/- 17,5 %	+/- 17,5 %	+/- 17,5 %
Speed	$\Delta p = 0$	n	13.200 1/min	13.200 1/min	13.200 1/min
Tolerance	PWM 0010		+/- 12,5 %	+/- 5 %	+/- 5 %
Starting current consumption				6.000 mA	

3.3 Electrical Interface - Output

Tacho type	/2 (open collector)
------------	---------------------

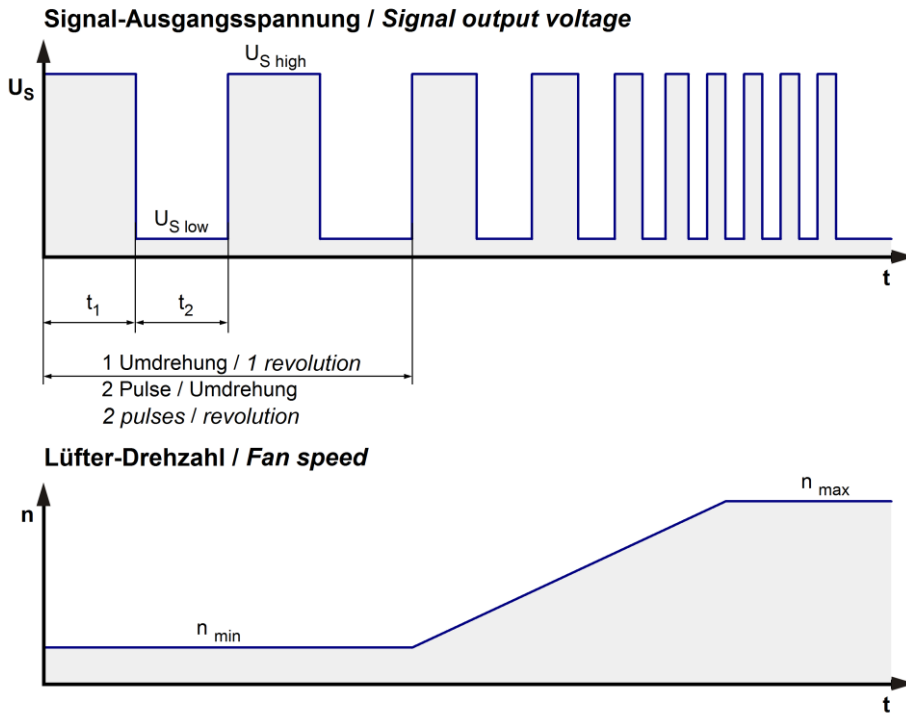

$$R_a = \frac{U_{BS} - U_{S\ low}}{I_{sink}}$$

Lüfter / Fan      Kunde / Customer

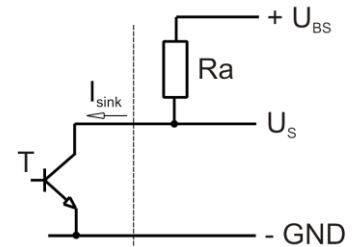

Features	Note	Values
Tacho operating voltage	$U_{BS}$	$\leq 30\ V$
Tacho signal Low	$U_{S\ low}$	$\leq 0,4\ V$
Tacho signal High	$U_{S\ high}$	$\leq 30\ V$
Maximum sink current	$I_{sink}$	$\leq 4\ mA$
External resistor	External resistor $R_a$ from $U_{BS}$ to $U_S$ required. All voltages measured to GND.	
Tacho frequency	$(2 \times n) / 60$	
Tacho isolated from motor	No	
Slew rate		$\Rightarrow 0,5\ V/\mu s$

n = revolutions per minute (1/min)

3.4 Electrical Features

Electronic function	Speed-Controlled	
Reversed polarity protection	Rectifying diode	
Max. residual current at $U_N$	$I_F \leq 100 \mu A$	
Locked rotor protection	Auto restart	
Locked rotor current at $U_N$	$I_{block}$ approx. 200 mA	
Clock signal at locked rotor	$t_3 / t_4$ typical: 2 s / 10,0 s	

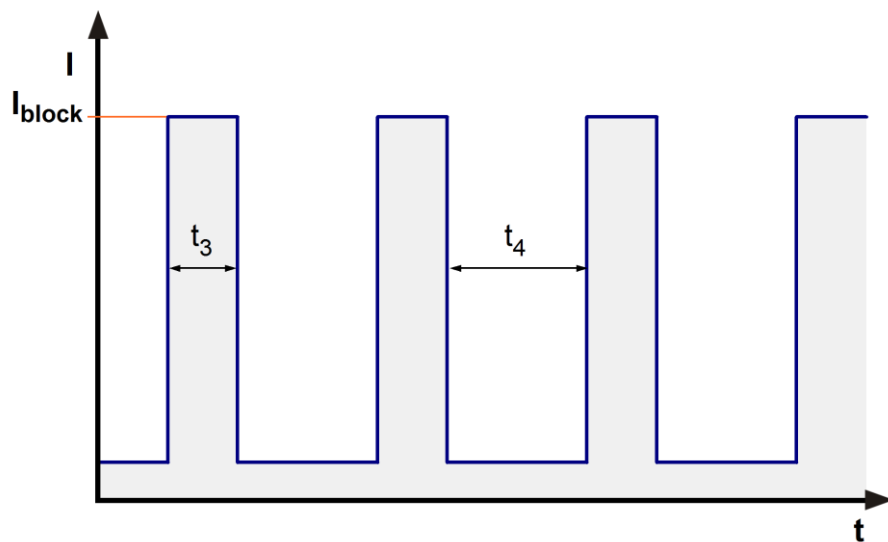



### 3.5 Aerodynamics

Measurement conditions: Measured with a double chamber intake rig acc. to DIN EN ISO 5801.  
 Normal air density = 1,2 kg/m<sup>3</sup>; Temperature 23°C +/- 3°C;  
 In the intake and outlet area should not be any solid obstruction within 0,5 m. Motor shaft horizontal.  
 The information is only valid under the specified test conditions and may be changed by the installation conditions. If there are deviations from the standard test conditions, the characteristic values must be checked under the installed conditions.

a.) Operation condition:

13.200 1/min at free air flow	PWM 100 %; f: 2 kHz		
-------------------------------	---------------------	--	--

Max. free-air flow ( $\Delta p = 0 / \dot{V} = \text{max.}$ )	175 m <sup>3</sup> /h	
Max. static pressure ( $\Delta p = \text{max.} / \dot{V} = 0$ )	840 Pa	

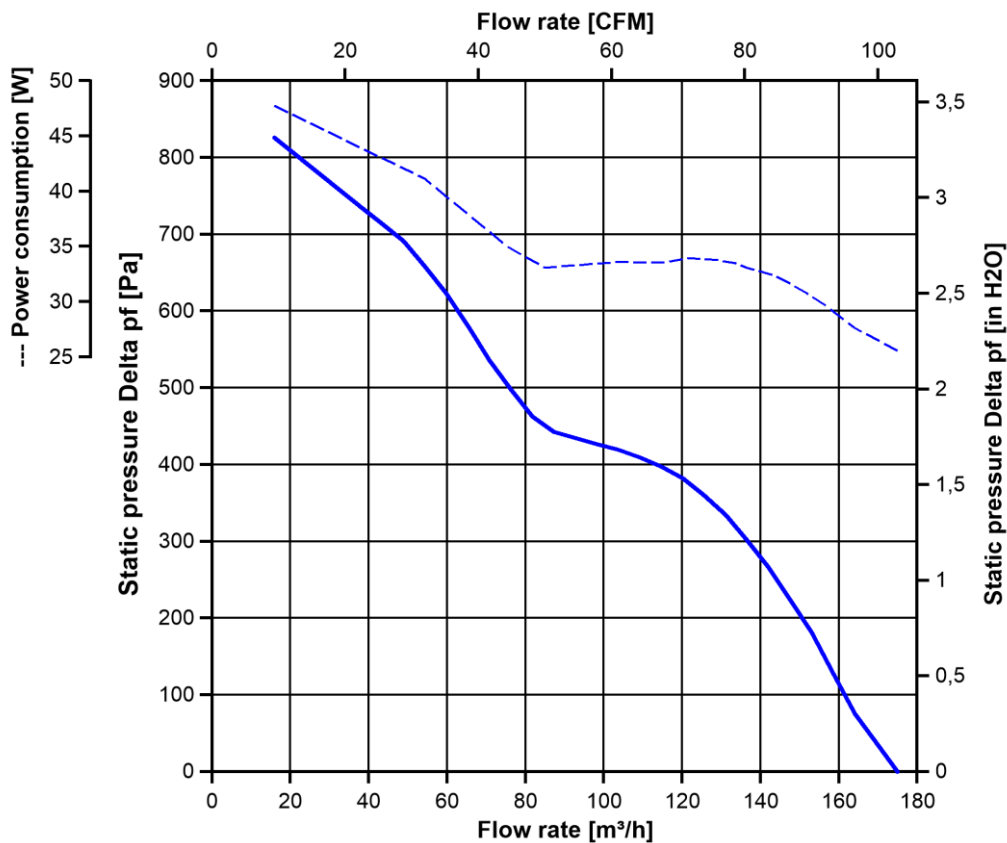

**3.6 Sound Data**

Measurement conditions: Sound pressure level: 1 meter distance between microphone and the air intake.  
 Sound power level: According to ISO 13347-3.  
 Measured in a semianechoic chamber with a background noise level of  $L_p(A) < 5 \text{ dB(A)}$   
 For further measurement conditions see chapter aerodynamics.

a.) Operation condition:

13.200 1/min at free air flow	PWM 100 %; f: 2 kHz		
-------------------------------	---------------------	--	--

Optimal operating point	125 m <sup>3</sup> /h @ 370 Pa		
Sound power level at the optimal operating point	7,9 bel(A)		
Sound pressure level at free air flow, measured in rubber bands	68 dB(A)		

Parts made with parts with pre-series tool.

**4 Environment**

**4.1 General**

Min. permitted ambient temperature TU min.	-20 °C		
Max. permitted ambient temperature TU max.	75 °C		
Min. permitted storage temperature TL min.	-40 °C		
Max. permitted storage temperature TL max.	80 °C		

## 4.2 Climatic Requirements

IP-protection type (certified)	IP 68 (for fan only, not for connector if applicable) **)	
Humidity requirements	humid temperature, cyclic; according to DIN EN 60068-2-38, 10 cycle and condensation water check; according to DIN EN ISO 6270-2, 14 days	
Salt fog requirements	salt fog, cyclic, in operation; according to DIN EN 60068-2-52, 3 cycle	

Permitted application area:

The product is for the use in open and unsheltered areas. Direct exposure to water as well as saline ambient conditions are allowed provided that this does not prevent the normal operation.

Pollution degree 3 (according DIN EN 60664-1)

It occurs conductive pollution or dry non-conductive pollution which becomes conductive due to condensation.

\*\* ) The specification of the IP protection refers to the conditions mentioned in certification of the fan. The above mentioned short description of the protection scope is not final. For detailed information of the respective protection scope and definitions, see certification as well as DIN EN 60529 (protection by housings) and ISO 20653 (for vehicles) with the letter K.

### **Short description of the IP-protection type:**

Solid particle Protection: Dust tight.

Protection against deliberate contact: Protected against contact to hazardous parts with a wire.

Protection against water: The fan test according to IP68 (Based on IEC 60529), is conducted in non-operating mode. The fan is tested by a complete immersion in water for a period of 2h at a water-level of 1,2m. Electrical connections are not immersed since they are customer specific.

Please require severity levels and specification parameters from the responsible development departments.

## 4.3 EMC

Kind	Radiated Emission; 30 MHz - 1000 MHz
According	DIN EN 55032:2016-02
Check accuracy / Limit	Class A
Result	Below limit Class A

Kind	Electrostatic Discharge Immunity Test
According	DIN EN 61000-4-2:2001-12
Check accuracy / Limit	Contact Discharge +/- 4 kV; Air Discharge +/- 8 kV
Result	A: The monitored function operates as designed during and after exposure to a disturbance.

**5 Safety****5.1 Electrical Safety**

Dielectric strength DIN EN 62368 and DIN EN 60335 A.) Type test Measuring conditions: After 48h of storage at 95% R.H. and 25°C. No arcing or breakdown is allowed! All connections together to ground. B.) Routine test Measuring conditions: At indoor climate. No arcing or breakdown is allowed! All connections together to ground.	500 VAC / 1 Min.  850 VDC / 1 Sec.	
Isolation resistance Measuring conditions: After 48h of storage at 95% R.H. and 25°C measured with U=500 VDC for 1 min.	RI > 10 MOhm	
Clearance / creepage distance	1,0 mm / 1,2 mm	
Protection class	III	

**5.2 Approval Tests**

CE	EC Declaration of Conformity	Yes
EAC	Eurasian Conformity	Yes
UL	Underwriters Laboratories	Yes / UL507, Electric Fans E38324
VDE	Association for Electrical, Electronic and Information Technologies	Yes / Approval acc. to EN 62368 - Audio/video, information and communication technology equipment
CSA	Canadian Standards Association	Yes / CSA audited by UL according to C22.2 No. 113 Fans and Ventilators
CCC	China Compulsory Certification	Yes / GB 12350 Safety Requirements for small Power Motors

**6 Reliability****6.1 General**

Life expectancy L10 at TU = 40 °C	57.500 h	
Life expectancy L10 at TU max.	22.500 h	
Life expectancy L10 acc. to IPC 9591 at TU = 40 °C	100.000 h	

The reproduction, distribution and utilization of this document as well as the communication of its contents to others without express authorization is prohibited. Offenders will be held liable for the payment of damages. All rights reserved in the event of the grant of a patent, utility model or design. Refer to protection notice ISO 18016.

**AxiForce 80 Baureihe**  
AxiForce 80 series

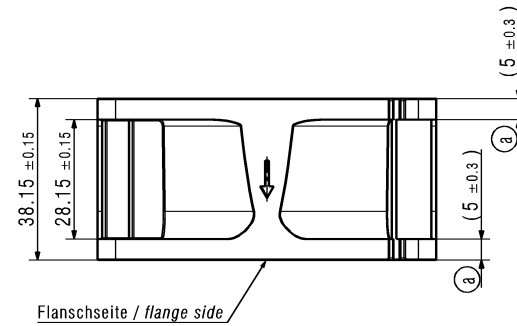
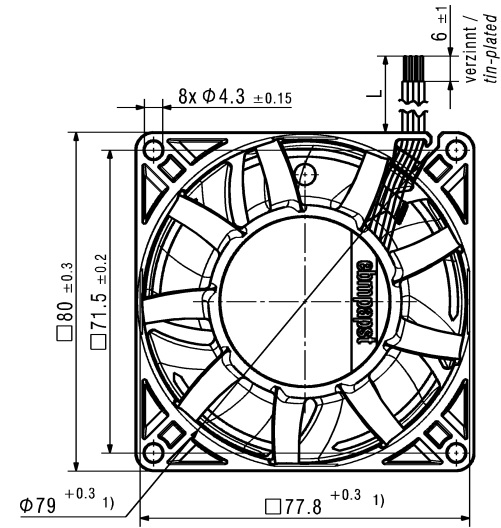
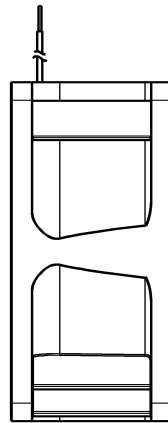
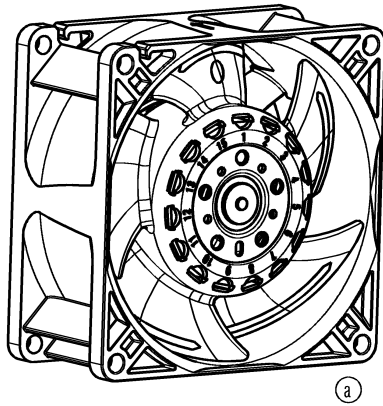

- 1) Maße für Montagewand / Dimensions for assembly wall
- Kein Axialspiel der Kugellager durch Federausgleich/  
No axial clearance of ball bearings due to a pre-load spring
  - Anzahl und Länge der Litze siehe Produktspezifikation  
Quantity and length of the wires according to design specification

Title				Material		Digital signature	
First created for		Index A	Doc type	Sheet	Change-No.		
Designed name		Designed date		Volume (mm³)		CAD environment	
Substitute for		Released name		Released date		Mass (g)	
<b>ebmpapst</b> ebm-papst St. Georgen GmbH & Co. KG				Tolerances		General tolerances	
				Scale		Format	
Document status							