

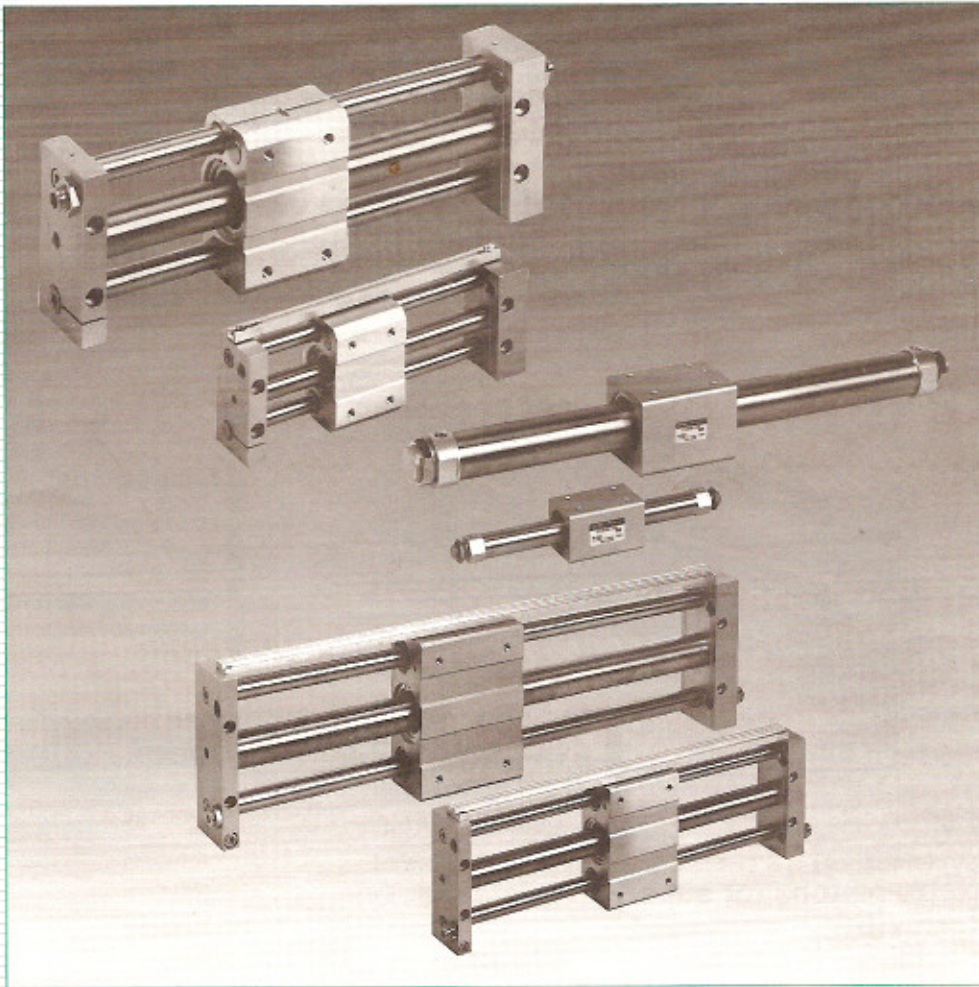

Air Cylinder

NCY2 Series

Magnetically Coupled Rodless Cylinder



Space Savings

Basic or Slider Model Available

2 Different Retaining Force Options

Long Stroke Available (up to 80" - Basic body)

Auto Switch Capable

Mounting space reduced by 1/2

Magnetically Coupled Rodless Cylinder *Series NCY2B/NCY2S*

The magnetically coupled cylinder is designed to be leak free due to no mechanical connection between the piston and the body. The NCY2S slider type offers guided support ideal for light loads when space is limited. The NCY2B basic type is designed to produce force in applications that require less support.

Basic

Series NCY2B



6 Bores Available
Standard tube I.D.s
are $\phi 6 \sim \phi 40$.

Great holding power

H type ($\phi 40$) - 227.94 lbs.
L type ($\phi 40$) - 140.65 lbs

The max. stroke is 80 inches

$\phi 6$ -12 in $\phi 10$ -20 in $\phi 15$ -40 in
 $\phi 25$, $\phi 32$, 40 - 80 in

Longer stroke available upon request

Slider

Slide Bearing Series NCY2S

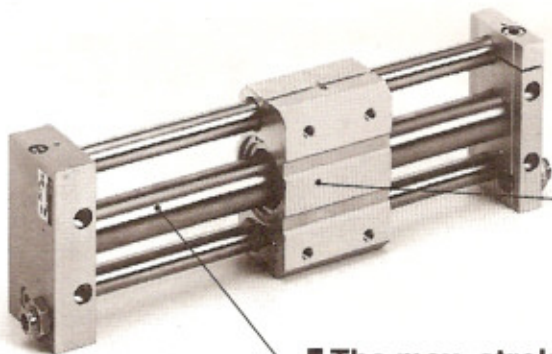

No external leakage

Force is applied through the magnetic coupling of the cylinder piston and guide body. A rod seal is not required. Intermediate stop positions are easier to maintain and longer service life can be achieved.

The max. stroke is 60 inches (as standard)

$\phi 6$ -12 in $\phi 10$ -20 in $\phi 15$ -30 in
 $\phi 25 \sim \phi 40$ -60 in

Bronze pistons for superior resistance
against wear

Two low friction U-cups on piston designed to lower
breakaway and compensate for seal wear adding to
cylinder life

Simple fine adjustment of stroke and
addition of auto switch after installation

Shock absorber for absorption of shock and noise

The SMC shock's original orifice design permits optimal energy absorption without adjustment within a wide range from high-speed small loads to low-speed large loads and from small energy to large energy.

Auto switch is attachable

An auto switch can be mounted in any position along stroke of cylinder.

Easy piping and wiring

Hollow shafts and special switch rails are adopted. (Porting from one end)

Direct mounting of load on slide block

Magnetically Coupled Rodless Cylinder Series **NCY2S**

Slide Bearing Type: $\phi 6, \phi 10, \phi 15, \phi 25, \phi 32, \phi 40$

How to Order

NC **D** Y2 **S** 25 **H** 05 25 **B** A73 **S** X116

With auto switch
With auto switch capability
Built in magnet

Mounting
S- Slider type

Stroke /
Inch*

Options
X116- Air Hydro
X161- High Speed
XB13- Low Speed

Number of switches

	2 pcs.
S	1 pc.
n	n pcs.

Applicable auto switch

Without auto switch			
Reed switch		Solid state switch	
A72	D-A72	F79	D-F79
A73	D-A73	F7P	D-F7P
A80	D-A80	J79	D-J79
A72H	D-A72H	F7NV	D-F7NV
A73H	D-A73H	F7PV	D-F7PV
A76H	D-A76H	F7BV	D-F7BV
A80H	D-A80H	J79C	D-J79C
A73C	D-A73C	F7NTL	D-F7NTL
A80C	D-A80C	2-color light	
		F7PW	D-F7PW
		J79W	D-J79W
		F7BAL	D-F7BAL
		F79F	D-F79F
		F7LF	D-F7LF

Bore size

Bore size (mm)	Bore size (inch)
6	1/4
10	3/8
15	5/8
25	1
32	1 1/4
40	1 1/2

Magnetic holding power*

H - Heavy duty
L - General purpose

*See table on page 8

Stroke/Hundredths of an inch*

*Note: Stroke length must be indicated as 4 digits. First and second digit: Stroke/Inch, Third and Fourth digit: Stroke/Hundredths of an inch.
Example: 0525 = 5.25 (5 1/4) Inch stroke

Stroke Adjustment

— - Adjustment bolts (Std) see pg. 11.

B - With shock absorbers

BS - With one shock absorber

BC - With cap type shock absorber

BCS - With one cap type shock absorber

"L" is added to the end when the lead wire is 3m long.

Example) A73L → D-A73L

However, 3m is applied to D-F7NTL and D-F7BAL by standard.

(Please consult SMC in case of 5m length.)

*Consult us when using a two-color display type auto switch (D-F79W).

To Order NCDY2S Switch Rail Separately

Bore	Part No.*
6	RCY6-O
10	RCY10-O
15	RCY15-O
25	RCY25-O
32	RCY32-O
40	RCY40-O

*O = specify stroke

Auto Switch Specifications (See applicable auto switch on P. 16 for details.)

Reed Switch

Auto switch No.	Load voltage	Max. load current and load current range (mA)	Application
D-A72-A72H	200VAC	5~10	Relay, Sequence controller
D-A73-A73H	24VDC	5~40	
	100VAC	5~20	
D-A76H	4~8VDC	20	IC circuit
D-A80-A80H	24V ^{AC} _{DC} or less	50	Relay, IC circuit, Sequence controller
	48V ^{AC} _{DC}	40	
	100V ^{AC} _{DC}	20	
D-A73C	24VDC	5~40	Relay, Sequence controller
D-A80C	24V ^{AC} _{DC} or less	50	Relay, IC circuit, Sequence controller

Switch Mounting Kit

Bore size	P/N	Switches
All	NCD-M3	All Available Switches

Solid State Switch

Auto Switch No.	Wiring method Output method	Power source	Load voltage-Load current	Application
D-F79	3 wire system (NPN)	5,12,24VDC (4.5~28VDC)	28VDC or less (150mA or less)	IC circuit, Relay, Sequence controller
D-F7P	3 wire system (PNP)		- (100mA or less)	
D-J79	2 wire system (-)	-	24VDC (10~28VDC) (5~150mA)	24VDC Relay, Sequence controller
D-F7NV	3 wire system (NPN)	5,12,24VDC (4.5~28VDC)	28VDC or less (150mA or less)	IC circuit, Relay, Sequence controller
D-F7PV	3 wire system (PNP)		- (100mA or less)	
D-F7BV	2 wire system (-)	-	24VDC (10~28VDC) (5~150mA)	24VDC Relay, Sequence controller
D-F7PW	3 wire system (PNP)	5,12,24VDC(4.5~28VDC)	- (80mA or less)	IC circuit, Relay, Sequence controller
D-J79W	2 wire system	-	24VDC (10~28VDC) (5~40mA)	24VDC Relay, Sequence controller
Improved water resistance D-F7BAL	2 wire system (-)	-	24VDC (10~28VDC) (5~40mA)	24VDC Relay, Sequence controller
D-J79C	2 wire system (-)	-	24VDC (10~28VDC) (5~150mA)	
D-F7LF	4 wire system (NPN)	24VDC (20~26VDC)	26VDC or less (40mA or less)	IC circuit, Relay, Sequence controller
D-F79F	3 wire system (NPN)	5,12,24VDC(4.5~28VDC)	28VDC or less (40mA or less)	
With timer D-F7NTL	3 wire system (NPN)	5,12,24VDC(4.5~28VDC)	28VDC or less (80mA or less)	Sequence controller

*A two-color display type auto switch (D-F79W) is mountable. Consult us when using it.

Series NCY2S

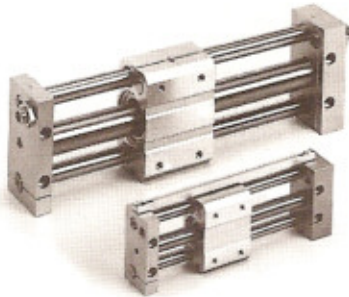

Model

Type	Bearing	Model	Bore size	Auto switch model	Adjustment
Slider	Oil impregnated bushing	NCY2S	φ6, φ10, φ15 φ25, φ32, φ40	D-A7-A8 type D-F7-J7 type	Adjusting bolt and Shock absorber

Specifications

1MPa=10.1972kgf/cm²

Fluid	Air
Proof pressure	152 psi {10.7kgf/cm ² }
Max. operating pressure	101 psi {7.1kgf/cm ² }
Min. operating pressure	26 psi {1.8kgf/cm ² }
Ambient and fluid temperature	14~140°F {-10~+60°C}
Operating piston speed	2~16 in/sec {50~400mm/s}
Cushion	Urethane cushion at both sides
Lubrication	Non-lube
Stroke tolerance (inch)	0~9.9st ₀ ^{±.0394} , 10~39.4st ₀ ^{±.065} , 39.5st ₀ ^{±.07}
Mounting position	Horizontal

* When setting an auto switch (in case of NCDY2S) at the intermediate position, the detectable max. piston speed is subject to the response time of the load (relay, sequence controller, etc.)

Standard Stroke

Bore size	Standard stroke (inch)	Manufacturable max. stroke (inch)
φ6	2, 3, 4, 5, 6, 8, 10	12
φ10	2, 3, 4, 5, 6, 8, 10	20
φ15	5, 10, 15, 20, 25, 30	30
φ25	5, 10, 15, 20, 25, 30, 40	60
φ32	5, 10, 15, 20, 25, 30, 40	
φ40	5, 10, 15, 20, 25, 30, 40	

Longer strokes available as special order

Magnetic Holding Power (lbs)

1 kg=2.2 lbs

1N=0.101972kgf

Type of magnetic holding power	φ6	φ10	φ15	φ25	φ32	φ40
H type	4.85	13.33	33.95	89.70	145.50	227.94
L type	-	-	20.13	54.55	88.50	140.65

Weight Table

(lbs)

Bore size (mm)	6	10	15	25	32	40	
Bore size (inch)	1/4	3/8	5/8	1	1 1/4	1 1/2	
Basic weight	NCY2B□H	0.59	1.06	2.00	4.05	8.00	8.85
	NCY2B□L	-	-	1.87	3.85	7.67	8.46
Additional weight per 1 in. stroke	0.048	0.084	0.117	0.192	0.300	0.454	

Calculation method/Example:

NCY2S32H-1050

Basic type, Bore 1.25 inch, stroke 10.5 inch

Basic weight 8.00 lbs

Additional weight 0.30/1 inch

Cylinder stroke 10.5inch

8.00+(0.30×10.5)=11.15 (lbs)

Main Parts

Description	Material	Note
Plate A,B	Aluminum alloy	Anodized
Cylinder tube	Stainless steel	-
Guide rod	Carbon steel	Hard chrome
Magnet	Rare earth metal magnet	-
Slide block	Aluminum alloy	Anodized

With shock absorber

See P.15 for the details of Series NCY2S.

Slider Type /Slide Bearing *Series NCY2S*

Construction/Parts List

NCY2S25H

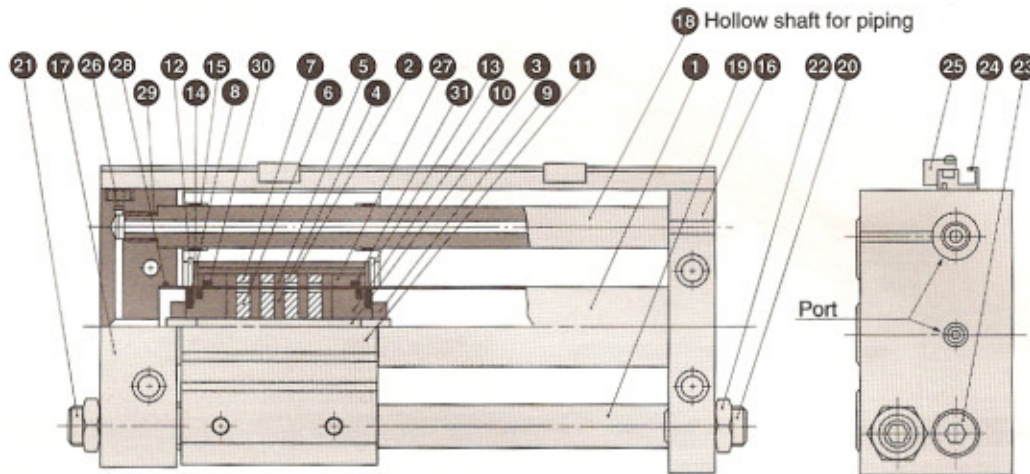

Parts List

No.	Description	Material	Note
1	Cylinder tube	Stainless steel	
2	External moving element side tube	Aluminum alloy	
3	Shaft	Stainless steel	
4	Piston side yoke	Rolled steel	Zinc chromate
5	External moving element side yoke	Rolled steel	Zinc chromate
6	Magnet A	Rare-earth metal magnet	
7	Magnet B	Rare-earth metal magnet	
8	Bumper	Urethane rubber	
9	Piston nut	Carbon steel	Zinc chromate
10	Piston	*Bronze	
11	Slide block	Aluminum alloy	Hard alumite
12	Moving element spacer	Rolled steel	Nickel plating
13	Retaining ring	Carbon tool steel	Nickel plating

Parts List

No.	Description	Material	Note
14	Spacer	Rolled steel	Nickel plating
15	Bushing	Bearing material impregnated with oil	
16	Plate A	Aluminum alloy	Hard alumite
17	Plate B	Aluminum alloy	Hard alumite
18	Guide shaft A	Carbon steel	Hard chromium plating
19	Guide shaft B	Carbon steel	Hard chromium plating
20	Adjusting bolt A	Chrome-Molybden steel	Nickel plating
21	Adjusting bolt B	Chrome-Molybden steel	Nickel plating
22	Hexagon nut	Carbon steel	Nickel plating
23	Hexagon socket head cap screw	Chrome-Molybden steel	Nickel plating
24	Switch mounting rail	Aluminum alloy	
25	Auto switch	-	
26	Plug	Brass	Nickel plating

*Brass in case of ø6 bore

Spare Parts/Exchange Parts

No.	Description	Bore size ø6		ø10		ø15		ø25		ø32		ø40	
		Packing set No.	CY2S6-PS	CY2S10-PS	CY2S15-PS	CY2S25-PS	CY2S32-PS	CY2S40-PS					
27	Scraper holder	CY-006-07-23536	2	CYB10-36-A8009	2	CYS15-36-A8019	2	CYS25-36-A8021	2	CYS32-36-A8022	2	CYS40-36-A8023	2
28	Cylinder tube gasket	C-8	2	C-12	2	C-17	2	C-27	2	C-34	2	C-42	2
29	Guide shaft gasket	C-6	1	C-8	1	C-7	1	C-8	1	C-12	1	C-18	1
30	Piston packing	DYP-6	2	DYP-10	2	PPY-15	2	PPY-25	2	PPY-32	2	SPY-40	2
31	Scraper	-	-	PDU-12Z	2	PDU-23x16	2	PDU-34x26	2	PDU-45x34	2	PDU-51x42	2

Applicable Grease (Soap group lithium grease with No.1 or No.2 consistency)

Grease name	Maker
Kyoseki Lisonix Grease No.1 Kyoseki Lisonix Grease No.2	Japan Energy
Lithtan No.1 Lithtan No.2 Lithtan EP1 Lithtan EP2	Esso Standard Sekiyu
Daphne Coronex Grease No.1 Daphne Coronex Grease No.2	Idemitsu Kosan
Diamond Multipurpose Grease No.1 Diamond Multipurpose Grease No.2	Mitsubishi Oil
Mobilux Grease No.1 Mobilux Grease No.2	Mobil Sekiyu

Grease name	Maker
Alvania Grease No.1 Alvania Grease No.2 Alvania EP Grease No.1 Alvania EP Grease No.2	Shell Sekiyu
Sunlight Grease No.2 Sunlight Grease EM1 Sunlight Grease EP1 Sunlight Grease EP2	Showa Sekiyu
Dynamic Grease MP1 Dynamic Grease MP2 Dynamic Grease S1 Dynamic Grease S2	Daikyo Sekiyu

Grease name	Maker
Kosmo Grease Dynamax No.1 Kosmo Grease Dynamax No.2	Kosmo Oil
Fukkol Multipurpose Grease No.1 Fukkol Multipurpose Grease No.2	Fuji Kosan
Multinoc Grease No.1 Multinoc Grease No.2 Epnoc Grease No.1 Epnoc Grease No.2	Nippon Oil
Gemico Grease MP-1 Gemico Grease MP-2 Gemico Grease MH-1 Gemico Grease MH-2	General Sekiyu

Note 1) The grease name No. shows the consistency.

Series NCY2S

Slider Type: Dimensions

NCY2S6,10

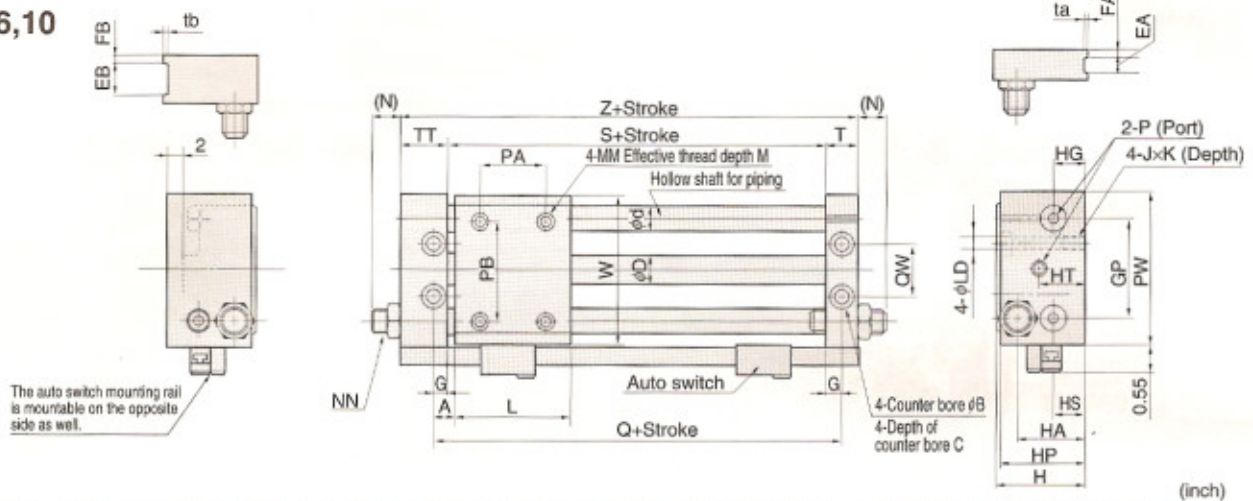

Model	Stroke range	A	φB	C	φD	φd	EA	EB	FA	FB	G	GP	H	HA	HG	HP	HS	HT	JxK
NCY2S6 NCDY2S6	~12 inch	0.28	0.26	0.13	0.30	0.31	-	-	-	-	0.20	1.26	1.06	0.75	0.31	1.02	0.31	0.67	No.8-32UNCx0.26
NCY2S10 NCDY2S10	~20 inch	0.31	0.31	0.17	0.47	0.39	.24	.47	.12	.20	0.26	1.57	1.37	1.00	0.51	1.30	0.55	0.74	No.10-32UNFx0.37

Model	L	LD	M	MM	(N)	NN	P	*PA	PB	PW	Q	QW	S	T	TT	ta	tb	W	Z
NCY2S6 NCDY2S6	1.57	.14	0.24	No.8-32UNC	0.35	3/8-32UNEF	No.10-32UNF	1.00	1.00	1.97	2.13	0.63	1.73	0.39	0.63	-	-	1.81	2.75
NCY2S10 NCDY2S10	1.77	.17	0.24	No.8-32UNC	0.37	3/8-32UNEF	No.10-32UNF	1.00	1.50	2.36	2.38	0.88	1.86	0.49	0.81	.02	.04	2.28	3.16

*The PA's dimension is symmetrical at the center.

NCY2S15,25,32,40

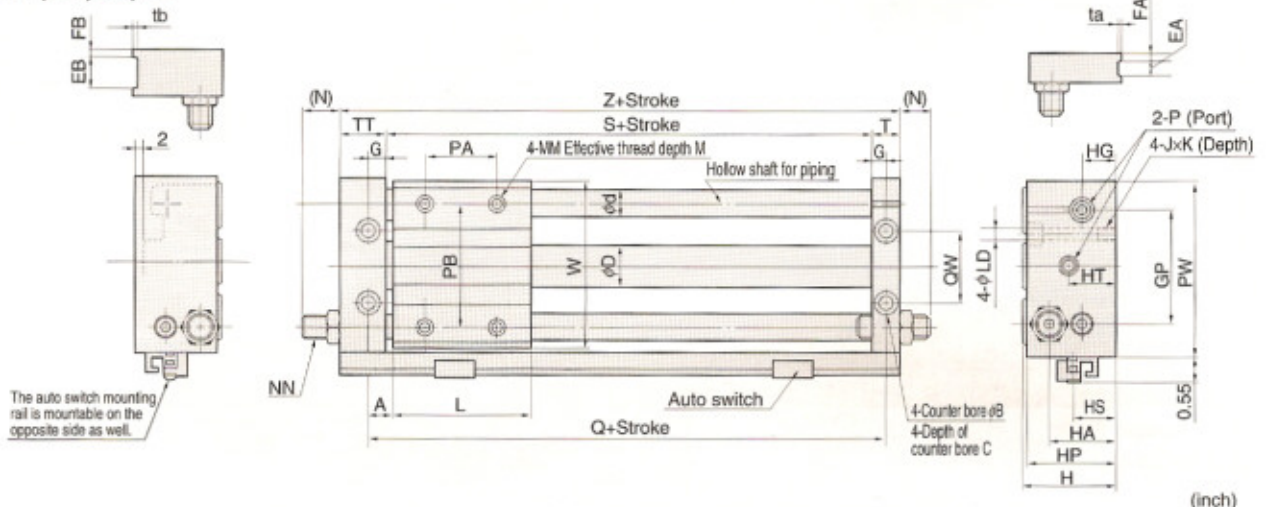

Model	Stroke range	A	φB	C	φD	φd	EA	EB	FA	FB	G	GP	H	HA	HG	HP	HS	HT	JxK
NCY2S15 NCDY2S15	~30 inch	0.32	0.38	0.20	0.65	0.47	.24	.51	.12	.24	0.26	2.05	1.63	1.14	0.56	1.54	0.59	0.88	1/4-28UNFx0.37
NCY2S25 NCDY2S25	~60 inch	0.37	0.44	0.26	1.04	0.63	.32	.55	.16	.28	0.33	2.76	2.13	1.57	0.79	2.09	0.91	0.79	5/16-24UNFx0.39
NCY2S32 NCDY2S32	~60 inch	0.45	0.55	0.31	1.32	0.79	.32	.63	.20	.28	0.37	3.39	2.63	1.97	0.97	2.52	1.06	0.97	3/8-24UNFx0.59
NCY2S40 NCDY2S40	~60 inch	0.51	0.55	0.31	1.64	0.98	.39	.79	.20	.39	0.41	4.09	3.00	2.05	0.99	2.91	1.18	0.99	3/8-24UNFx0.59

Model	L	LD	M	MM	(N)	NN	P	*PA	PB	PW	Q	QW	S	T	TT	ta	tb	W	Z
NCY2S15 NCDY2S15	2.36	.22	0.31	No.10-32UNF	0.28	1/2-20UNF	No.10-32UNF	1.25	2.00	2.95	3.00	1.13	2.48	0.49	0.89	.02	.04	2.83	3.86
NCY2S25 NCDY2S25	2.76	.28	0.39	1/4-28UNF	0.46	9/16-18UNF	NPT 1/8	1.50	2.75	3.94	3.50	1.63	2.84	0.65	1.00	.02	.04	3.82	4.49
NCY2S32 NCDY2S32	3.35	.34	0.47	5/16-24UNF	0.50	3/4-16UNF	NPT 1/8	1.63	3.00	4.80	4.25	2.00	3.51	0.73	1.12	.02	.04	4.69	5.36
NCY2S40 NCDY2S40	3.74	.34	0.47	5/16-24UNF	0.39	3/4-16UNF	NPT 1/4	2.5	4.13	5.71	4.75	2.50	3.93	0.81	1.40	.02	.04	5.59	6.14

*The PA's dimension is symmetrical at the center.

Series NCY2S

Slider Type

Application Information

① Horizontal operation (Mounted on floor)

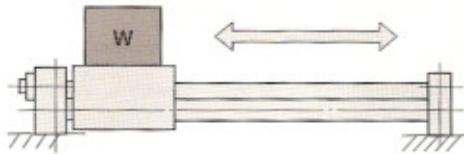

Max. live load (Center of slide block) (kg)

Bore size	φ6	φ10	φ15	φ25	φ32	φ40
W (kg)	1.8	3.0	7.0	20.0	30.0	50
Stroke (MAX)	12 in.	20 in.	30 in.	60 in.	60 in.	60 in.

Basic design value: Those of the max. allowable load are 60% of the max. thrust (P=0.7MPa). However, the above load is subject to the stroke length in case of every cylinder size due to the limit for deflection of the guide shaft. (Be careful of coefficient α.) In case of some operational direction, the allowable load may be different from the basic design value.

② Horizontal operation (Mounted to wall)

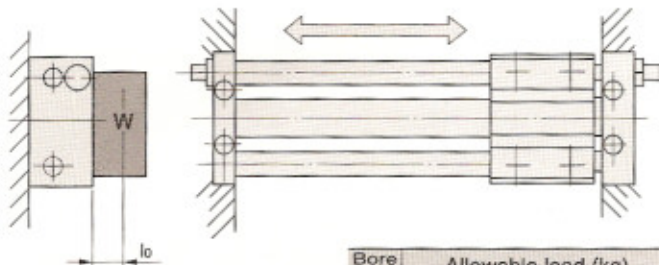

l₀: Distance from mounting surface to load's center of gravity (cm)

Bore size	Allowable load (kg)
φ6	$\frac{\alpha \cdot 5.44}{7+2l_0}$
φ10	$\frac{\alpha \cdot 12.0}{8.4+2l_0}$
φ15	$\frac{\alpha \cdot 36.4}{10.6+2l_0}$
φ25	$\frac{\alpha \cdot 140}{13.8+2l_0}$
φ32	$\frac{\alpha \cdot 258}{17+2l_0}$
φ40	$\frac{\alpha \cdot 520}{20.6+2l_0}$

③ Vertical movement

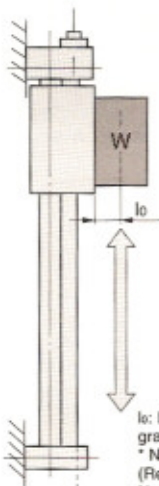

Bore size	Allowable load (kg)
φ6	$\frac{1.33}{1.9+l_0}$
φ10	$\frac{4.16}{2.2+l_0}$
φ15	$\frac{13.23}{2.7+l_0}$
φ25	$\frac{44.0}{3.4+l_0}$
φ32	$\frac{88.2}{4.2+l_0}$
φ40	$\frac{167.8}{5.1+l_0}$

l₀: Distance from mounting surface to load's center of gravity (cm)
 * Note) Principally, it becomes impossible to operate. (Reference value)
 Note) A safety coefficient for avoiding fall is taken into consideration.

④ Inclined operation (Operational direction)

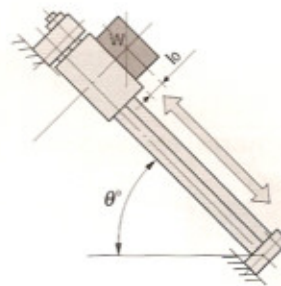

Angle	-45°	-60°	-75°	-90°
k	1	0.9	0.8	0.7

Angle coefficient [k]: k=[-45°(-θ)]=1
 [-60°]=0.9, [-75°]=0.8,
 [-90°]=0.7

l₀: Distance from mounting surface to load's center of gravity (cm).

Bore size	Allowable load (kg)
φ6	$\frac{\alpha \cdot 5.1 \cdot K}{3\cos\theta+2(1.9+l_0)\sin\theta}$
φ10	$\frac{\alpha \cdot 10.5 \cdot K}{3.5\cos\theta+2(2.2+l_0)\sin\theta}$
φ15	$\frac{\alpha \cdot 35 \cdot K}{5\cos\theta+2(2.7+l_0)\sin\theta}$
φ25	$\frac{\alpha \cdot 120 \cdot K}{6\cos\theta+2(3.4+l_0)\sin\theta}$
φ32	$\frac{\alpha \cdot 210 \cdot K}{7\cos\theta+2(4.2+l_0)\sin\theta}$
φ40	$\frac{\alpha \cdot 400 \cdot K}{8\cos\theta+2(5.1+l_0)\sin\theta}$

⑤ Inclined operation (Vertical to operational direction)

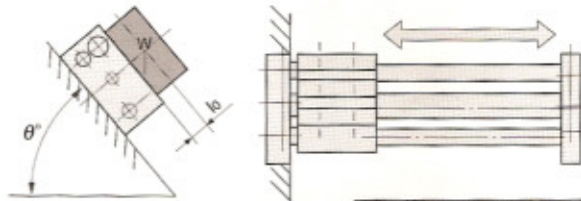

l₀: Distance from mounting surface to load's center of gravity (cm)

Bore size	Allowable load (kg)
φ6	$\frac{\alpha \cdot 5.44}{3.2+2(1.9+l_0)\sin\theta}$
φ10	$\frac{\alpha \cdot 12.0}{4+2(2.2+l_0)\sin\theta}$
φ15	$\frac{\alpha \cdot 36.4}{5.2+2(2.7+l_0)\sin\theta}$
φ25	$\frac{\alpha \cdot 140}{7+2(3.4+l_0)\sin\theta}$
φ32	$\frac{\alpha \cdot 258}{8.6+2(4.2+l_0)\sin\theta}$
φ40	$\frac{\alpha \cdot 520}{10.4+2(5.1+l_0)\sin\theta}$

⑥ The load's center of gravity is offset in the operational direction. (I)

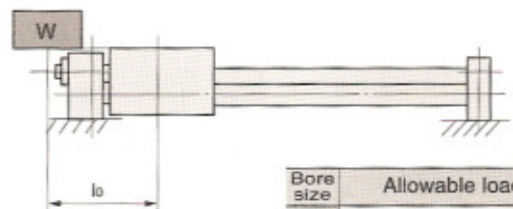

l₀: Distance from mounting surface to center of slide block (cm)

Bore size	Allowable load (kg)
φ6	$\frac{\alpha \cdot 2.55}{l_0+3}$
φ10	$\frac{\alpha \cdot 5.25}{l_0+3.5}$
φ15	$\frac{\alpha \cdot 17.5}{l_0+5.0}$
φ25	$\frac{\alpha \cdot 60}{l_0+6.0}$
φ32	$\frac{\alpha \cdot 105}{l_0+7.0}$
φ40	$\frac{\alpha \cdot 200}{l_0+8.0}$

Series NCY2S

⑦ Horizontal operation (Load pressing, Pressure)

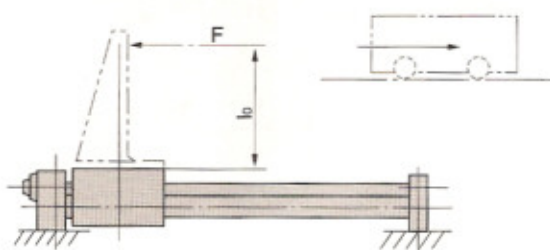

F: Drive (Position, l_0 from slide block) drag (kg)
 l_0 : Distance from mounting surface to load's center of gravity (cm)

Bore size	Allowable load (kg)
$\phi 6$	$\frac{\alpha \cdot 2.55}{1.9 + l_0}$
$\phi 10$	$\frac{\alpha \cdot 5.25}{2.2 + l_0}$
$\phi 15$	$\frac{\alpha \cdot 17.5}{2.7 + l_0}$
$\phi 25$	$\frac{\alpha \cdot 60}{3.4 + l_0}$
$\phi 32$	$\frac{\alpha \cdot 105}{4.2 + l_0}$
$\phi 40$	$\frac{\alpha \cdot 200}{5.1 + l_0}$

⑧ Horizontal operation [Load, Offset in operational direction (I)]

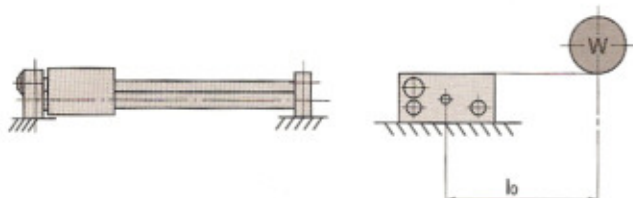

l_0 : Distance from center of slide block to load's center of gravity (cm)

Bore size	Allowable load (kg)
$\phi 6$	$\frac{\alpha \cdot 3.80}{3.2 + l_0}$
$\phi 10$	$\frac{\alpha \cdot 8.40}{4 + l_0}$
$\phi 15$	$\frac{\alpha \cdot 25.48}{5.2 + l_0}$
$\phi 25$	$\frac{\alpha \cdot 98}{7.0 + l_0}$
$\phi 32$	$\frac{\alpha \cdot 180}{8.6 + l_0}$
$\phi 40$	$\frac{\alpha \cdot 364}{10.4 + l_0}$

How to calculate α when selecting allowable load

α should be considered to be a coefficient decided in accordance with each stroke because the max. allowable load is related to the cylinder stroke and varies as shown in the table below.

Ex.) In case of NCY2S25-2560:

- (1) Max. allowable load=20kg
 (2) Max. allowable load in case of (650)st=13.6kg (25.6inch*25.4=650mm)
 (3) $\alpha = \frac{13.6}{20} = 0.68$

Calculation formula for α ($\alpha < 1$)
 1 inch = 25.4mm
 ST: Stroke (mm)

Model	NCY2S6	NCY2S10	NCY2S15
$\alpha =$	1	$\frac{10^{(0.66 - 1.3 \times 10^{-3} \times ST)}}{3}$	$\frac{10^{(1.5 - 1.3 \times 10^{-3} \times ST)}}{7}$

Model	NCY2S25	NCY2S32	NCY2S40
$\alpha =$	$\frac{10^{(1.98 - 1.3 \times 10^{-3} \times ST)}}{20}$	$\frac{10^{(2.26 - 1.3 \times 10^{-3} \times ST)}}{30}$	$\frac{10^{(2.48 - 1.3 \times 10^{-3} \times ST)}}{50}$

Note) Apply $\alpha=1$ in case of : $\phi 10$ -300mmST, $\phi 15$ -500mmST, $\phi 25$ -500mmST, $\phi 32$ 0-600mmST, and $\phi 40$ -600mmST at the max.

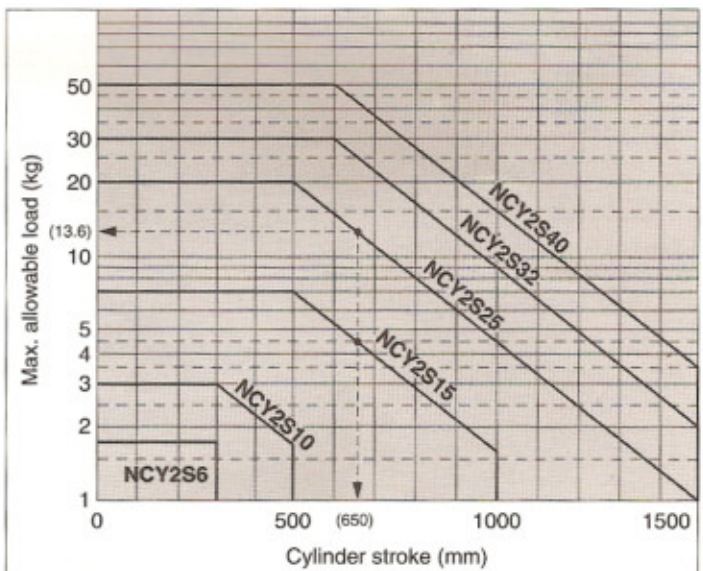

Cautions on use

- Avoid applying a load to the cylinder exceeding the calculation value in the data for selection.
- Secure the cylinder not to the slide block but to the plate.
- Consult us for operation under an ambience where the cylinder (surface of cylinder tube/guide shaft) may be exposed to water (hot water) or cooling liquid.
- Periodically grease the bearing of the slide block. (See the applicable greases described on P.9.)
- Consult our sales dept. for the change of the magnet holding power (ex. NCY2S25L → NCY2S25H), which should be changed in our plant.
- Avoid disassemble the magnet's component (piston moving element or external moving element), which may cause holding power's deterioration or defect.
- Principally, avoid operation in a vertical direction. If it cannot be avoided, consult us.

Shock Absorber Specifications/Series NRB

See the "shock absorber" in the catalog (CAT. N371) for details.

Applicable rodless cylinder		NCY2S6,10	NCY2S15	NCY2S25	NCY2S32, 40
Shock absorber model		NRB(C)37-025	NRB(C)50-030	NRB(C)56-045	NRB(C)75-045
Capacity	in. lb/cycle(kgf•m/cycle)	25(0.3)	50(0.6)	170(2)	170(2)
Stroke	in. (mm)	0.25(6)	0.30(7)	0.45(12)	0.45(12)
Velocity	ft/s(m/s)	16(5)			
*Frequency	cycle/min	80	70	45	45
Temperature	*F(*C)	14~176(-10~80)			
Spring force lbs {kgf}	Extended	0.77(0.35)	1.43(0.65)	1.54(0.70)	1.54(0.70)
	Compressed	1.65(0.75)	2.12(0.96)	3.59(1.63)	3.59(1.63)
Weight	lbs (gf)	0.04(20)	0.08(35)	0.13(60)	0.26(120)

* It is the max. absorption energy/hour per 1 cycle. Therefore, the operating frequency can be increased according to the absorption energy.

With shock absorber/Dimensions

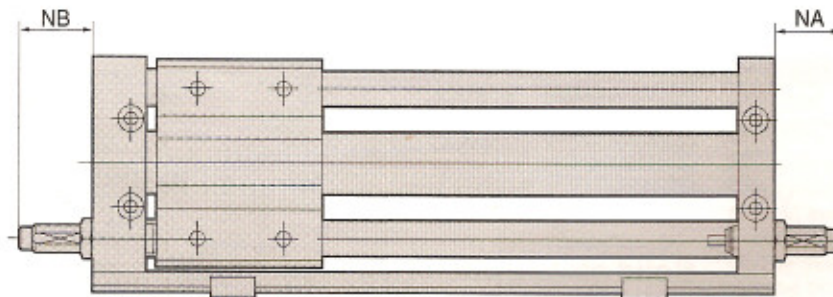

Type	Applicable shock absorber	(mm)	
		NA	NB
NC□Y2S6	NRB37-025	30	24
NC□Y2S10		27	19
NC□Y2S15	NRB50-030	33	23
NC□Y2S25	NRB56-045	49	40
NC□Y2S32	NRB75-045	48	38
NC□Y2S40		47	32

Series NCY2 Auto Switch Specifications

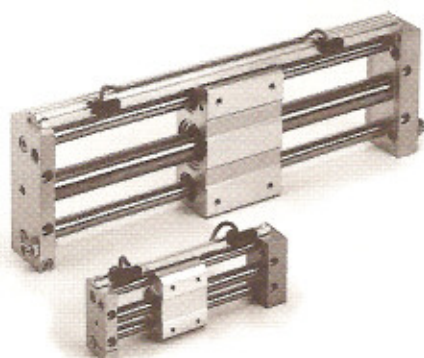

Applicable auto switch model

Applicable series	Applicable Cylinder Bore size (mm)	Applicable auto switch		Electrical entry
NCDY2S (Slider type)	φ6, φ10 φ15, φ25 φ32, φ40	Reed switch	D-A7-A8	Grommet (Vertical take-out)
			D-A7□H-A80H	Grommet (Horizontal take-out)
			D-A73C-A80C	Connector
		Solid state switch	D-F7/J7	Grommet (Horizontal take-out)
			D-F7NTL	Grommet (With timer-Horizontal take-out)
			D-F7□V	Grommet (Vertical take-out)
			D-J79C	Connector
			D-F7PW/J79W	Grommet (2-color indication-Horizontal take-out)
			D-F7□F	Grommet (2-color indication-With diagnosis output-Horizontal take-out)
			D-F7BAL	Grommet (2-color indication-Improved water resistance-Horizontal take-out)

Reed switch/Rail mount type

Auto switch model	Load voltage	Max. load current and load current range mA	Indicator lamp (ON: Lit)	Contact protection circuit	Applications
D-A72-A72H	200VAC	5~10	●	None	Relay, Sequence controller
D-A73 D-A73H	24VDC 100VAC	5~40 5~20	●	None	
D-A80 D-A80H	24V ^{AC} _{DC} or less 48V ^{AC} _{DC} 100V ^{AC} _{DC}	50 40 20	None	None	IC circuit, Relay, Sequence controller
D-A76H	4~8VDC	20	●	None	IC circuit
D-A73C	24VDC	5~40	●	None	Relay, Sequence controller
D-A80C	24V ^{AC} _{DC} or less	50	None	None	IC circuit, Relay, Sequence controller

Solid state switch/Rail mount type

Auto switch model	Wiring method Output method	Power voltage	Load current	Internal voltage drop Load current in case of 10mA	Indicator lamp (ON: Lit)	Applications	Function
D-F79	3 wire system NPN	5, 12, 24 VDC (4.5~28VDC)	150mA or less	0.8V or less	●	IC circuit, Relay, Sequence controller	-
D-F7NV			150mA or less	0.8V or less	●	IC circuit, Relay, Sequence controller	Lead wire: Vertical take-out
D-F7NTL			80mA or less	0.8V or less	●		With 200ms off-delay timer
D-F7P	3 wire system PNP		100mA or less	0.8V or less	●	IC circuit, Relay, Sequence controller	-
D-F7PV			100mA or less	0.8V or less	●		Lead wire: Vertical take-out
D-F7PW			80mA or less	0.8V or less	◎		2-color indication
D-J79	2 wire system	-	5~150mA	3V or less	●	24VDC Relay, Sequence controller	-
D-J79C			5~150mA	3V or less	●		Connector type
D-F7BV			5~150mA	3V or less	●		Lead wire: Vertical take-out
D-F7BAL			5~40mA	4V or less	◎		Improved water resistance
D-J79W			5~40mA	4V or less	◎		2-color indication
D-F79F	4 wire system NPN	5, 12, 24 VDC (4.5~28VDC)	40mA or less	0.8V or less	◎	IC circuit, Relay, Sequence controller	With diagnosis output
D-F7LF	NPN	24 VDC (20~26VDC)	40mA or less	0.8V or less	◎	24VDC Relay, Sequence controller	With latch type diagnosis output

Two-color display type

Series NCDY2

Auto switch/Internal circuit

Reed switch

D-A72, D-A72H

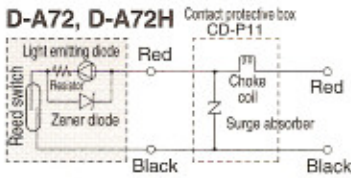

D-A73C

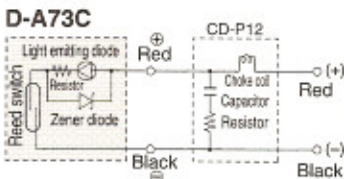

D-A73, D-A73H

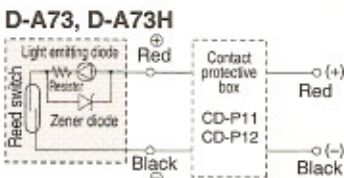

D-A76H

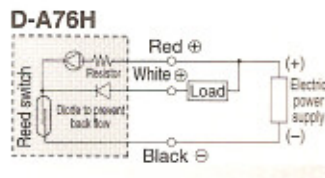

D-A80C

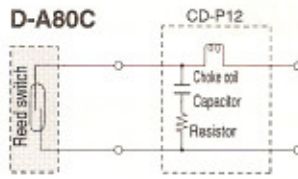

D-A80, D-A80H

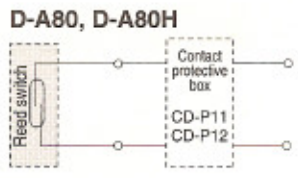

Solid state switch

D-F79, D-F7NV

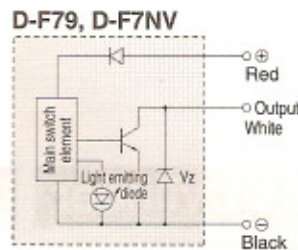

D-F7P, D-F7PV

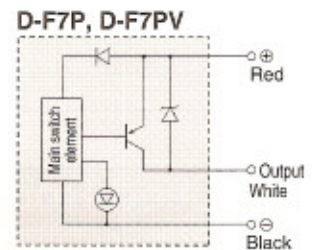

D-J79, D-J79C, D-F7BV

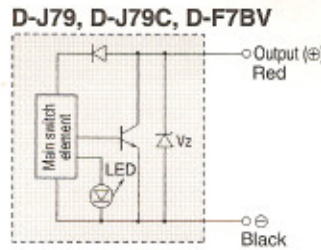

Mounting interchange ability with reed switch. It is possible to change type of switch because of its mounting compatibility.

Solid state switch Reed switch
 D-F7 type } ← D-A7 type
 D-J79 type }

Contact protective box/CD-P11,CD-P12

The auto switches of D-A7-A8 type, D-A7 H-A80H type, D-A7 C-A80C type, D-C7-C8 type are not incorporated with contact protective circuit.

- ① Operating load in an inductive load.
- ② The wiring length to load is 5m or more.
- ③ The load voltages are 100 or 200VAC. Either voltage should be used with the contact protective box.

Contact protective box of specifications

Part No.	CD-P11	CD-P12
Load voltage	100VAC	200VAC
Max. load current	25mA	12.5mA
Lead wire length	Switch connecting side 0.5m	
	Load connecting side 0.5m	

Lead wire length—Switch connecting side 0.5m
 Load connecting side 0.5m

Contact protective box/Internal circuit

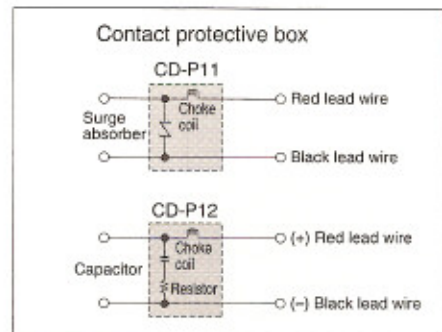

Contact protective box/Connection method

For connection of the switch body and the contact protective box, connect the load in the side indicated as switch on the contact protective box to the lead from the switch body. The length of lead between the switch body and the contact protective box should be within 1m and they should be set as close as possible.

How to connect solid state switch

3 wire system (When power source for switch and load is common)

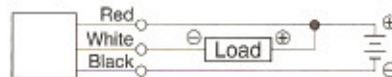

3 wire system (When power source for switch and load is not common)

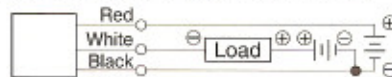

2 wire system



Red lead wire: Connect to the power source (+) (power source terminal) to operate main circuit of switch. In case of 2 wire systems connect with (-) side of load.

White lead wire: Connect to load (to the input of sequence controller and outlet relay)

Black lead wire: Connect to the power source (-).

Precautions

Solid state switch

- ① Load over the maximum load capacity of the switch should not be used.
- ② The switch should not be connected to the power supply until after connection to the load.
- ③ All switch types have functions to protect against incorrect connection, output short or over load in order to prevent damage of the switch. Since incorrect wiring may cause problems on the load side, caution should be exercised when wiring.
- ④ Since a D.C. 2 wire system auto switch is 3V or less in the internal voltage drop and 1mA or less in the leak current, it satisfies the input specification of most sequence controllers. If some trouble arises, a D.C. 3 wire system should be used.

Precautions

Reed switch

Contact capacity

- ① Loads over the maximum contact capacity of the switch should not be used.

Fuji Electric	Omron	Matsushita Electric
HH5 type	MY type	HC type
Tokyo electric	Idec Izumi	Mitsubishi Electric
MPM type	RM type	RD type

Wiring/current-voltage

- ① Auto switch: connect first a load and then connect the power source.
- ② The switches with 24VDC, indicator lamp have polarity. The red lead is (+) and the black lead is (-). [In case of D-97 type, the no-display side is (+) and the black-line-display side is (-).] The reverse connection allows the switch to operate but the light emitting diode does not light. If the current exceeds the specification failure may occur.

Applicable model: D-A73, A73H, A73C, E73A, Z73/D-97, 93A, A79W/D-A33, A34, A33A, A34A, A44, A44A/D-A53, A54, B53, B54

- ③ Switch with indicator lamp (without A76H)
 - 1) If using less than a specified current, the light emitting diode goes to dark light or does not light, but operation of the switch is possible.
 - 2) If the switches are connected in series as shown in the following figure, it makes voltage drop larger by the internal resistance of the light emitting diode (Refer to the internal resistance voltage in the auto switch specification).



- 3) If using less than a specified voltage, the load may not operate due to the internal voltage drop of switch even. In voltage drop, the allowable voltage range of load should be confirmed.
- ④ If an internal resistance of the light emitting diode causes trouble, the switches with no indicator lamp (D-A8) should be used. 17

Series NCY2

Specifications for made to order models

Contact SMC for the details of dimensions, specifications, and date of delivery.

High Speed Rodless Cylinder

NC(D)Y2S Bore Number of Magnets Stroke X161

NCY2B Bore size Type of magnetic holding power Stroke X160

High speed drive with a piston speed of 1500mm/s (basic type) is possible. (When without load)

Specifications

Applicable series	NCY2B
Bore size (mm)	φ25-φ40
Piston speed (when without load)	Basic 2 - 60 in/s (50 - 1500mm/s)
	Slider 2 - 40 in/s (50 - 1000mm/s)

Note 1) When operating this cylinder at high speed, be sure to provide a shock absorber.
 Note 2) The standard type of CY1S and CY1L can produce max. piston speed of 1000mm/s.
 Note 3) Bore 6 - 15 (basic type) are fully ported and do not require the x160 option.

Low Speed Rodless Cylinder

<Basic type>

NCY2B Bore size Type of magnetic holding power Stroke XB13

<Slider type>

NCY2S Bore size Type of magnetic holding power Stroke Stroke Adjustment Switch XB13

Specifications

Type	Basic type, Slider type
Bore size	Basic type NCY2B6-40 Slider type NCY2S6-40
Fluid	Air
Piston speed	7-50 mm/s

Air Hydro Rodless Cylinder

<Basic type>

NCY2B Bore size Type of magnetic holding power Stroke X116

<Slider type>

NCY2S Bore size Type of magnetic holding power Stroke Stroke Adjustment Switch X116

Specifications

Type	Basic type, Slider type
Bore size	Basic type NCY2B25-40 Slider type NCY2S25-40
Fluid	Hydraulic fluid
Piston speed	15-300mm/s

Note) Piping is from each plate on both sides

Dimensions

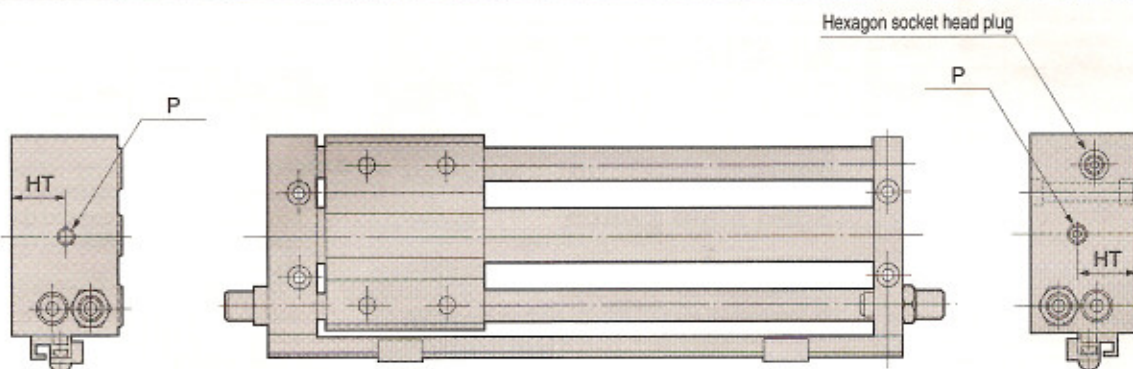

Model	HT	P	Restriction diam
NCY2S25	20	Rc(PT)1	7.5
NCY2S32	24		
NCY2S40	25	Rc(PT) 1/4	10

Limited Cylinder Warranty — Terms and Conditions of Sale...

SMC Pneumatics, Incorporated (SMC) warrants that for 18 months or 1800 service miles*, whichever occurs first, from date of purchase it will replace, or make adjustment at SMC's option, of any defective cylinder product sold if the cylinder product is returned with SMC's prior written consent, transportation prepaid by the original buyer, and received by SMC at its place of business in Indianapolis, Indiana within the warranty period.

SMC shall have the right to inspect, prior to return, at the buyers facility, any products claimed to be defective.

This warranty is limited exclusively to cylinder products which, in the opinion of SMC, have not been subjected to modification, misuse, negligence, misapplication, repairs or alterations. Damage caused by fire, theft, riot, explosion, or acts of God

are excluded from this warranty. The foregoing constitutes the sole exclusive remedy of the buyer and the only liability of SMC and is in lieu of any and all other warranties, expressed or implied, or statutory as to merchantability, fitness for purpose sold, description quality, productiveness or any other matter. SMC shall not be liable for loss of use, or profit, of special or consequential damages.

SMC assumes no responsibility for engineering or technical advice pertaining to any manufactured item to which SMC's products or goods have been attached. No agent, employee, distributor, or representative of SMC has the authority to extend the scope of this warranty or to make any other promises, warranties or guarantees concerning the manufacture, sale or application of SMC's products.

World Wide SMC Support...

North American Branch Offices For a branch office near you call: 1-800-SMC-SMC1 (762-7621)

SMC Pneumatics Inc. (Atlanta)
1440 Lakes Parkway, Suite 600
Lawrenceville, GA 30043
Tel: (770) 624-1940
FAX: (770) 624-1943

SMC Pneumatics Inc. (Columbus)
3687 Corporate Drive
Columbus, OH 43231
Tel: (614) 895-9765
FAX: (614) 895-9780

SMC Pneumatics Inc. (Mnpls.)
990 Lone Oak Road, Suite 162
Eagan, MN 55121
Tel: (612) 688-3490
FAX: (612) 688-9013

SMC Pneumatics Inc. (S.F.)
85 Nicholson Lane
San Jose, CA 95134
Tel: (408) 943-9600
FAX: (408) 943-9111

SMC Pneumatics Inc. (Austin)
2324-D Ridgepoint Drive
Austin, TX 78754
Tel: (512) 926-2646
FAX: (512) 926-7055

SMC Pneumatics Inc. (Dallas)
12801 N. Stemmons Frwy, Ste. 815
Dallas, TX 75234
Tel: (972) 406-0082
FAX: (972) 406-9904

SMC Pneumatics Inc. (Nashville)
5000 Linbar Drive, Suite 297
Nashville, TN 37211
Tel: (615) 331-0020
FAX: (615) 331-9950

SMC Pneumatics Inc. (St. Louis)
4130 Rider Trail North
Earth City, MO 63045
Tel: (314) 209-0080
FAX: (314) 209-0085

SMC Pneumatics Inc. (Boston)
Zero Centennial Drive
Peabody, MA 01960
Tel: (978) 326-3600
Fax: (978) 326-3700

SMC Pneumatics Inc. (Detroit)
44345 Macomb Industrial Dr.
Clinton Township, MI 48036
Tel: (810) 463-2300
FAX: (810) 463-2344

SMC Pneumatics Inc. (Newark)
3434 US Hwy. 22 West, Ste. 110
Somerville, NJ 08876
Tel: (908) 253-3241
FAX: (908) 253-3452

SMC Pneumatics Inc. (Tampa)
8507-H Benjamin Road
Tampa, FL 33634
Tel: (813) 243-8350
FAX: (813) 243-8621

SMC Pneumatics Inc. (Charlotte)
5029-B West W.T. Harris Blvd.
Charlotte, NC 28269
Tel: (704) 597-9292
FAX: (704) 596-9561

SMC Pneumatics Inc. (Houston)
9001 Jameel, Suite 180
Houston, TX 77040
Tel: (713) 460-0782
FAX: (713) 460-1510

SMC Pneumatics Inc. (Phoenix)
2001 W. Melinda Lane
Phoenix, AZ 85027
Tel: (602) 492-0908
FAX: (602) 492-9493

SMC Pneumatics Inc. (Tulsa)
10203 A East 61st Street
Tulsa, OK 74146
Tel: (918) 252-7820
FAX: (918) 252-9511

SMC Pneumatics Inc. (Chicago)
27725 Diehl Road
Warrenville, IL 60555
Tel: (630) 393-0080
FAX: (630) 393-0084

SMC Pneumatics Inc. (Indpls.)
3011 N. Franklin Rd.
Indianapolis, IN 46226
Tel: (317) 899-4743
FAX: (317) 898-4808

SMC Pneumatics Inc. (Portland)
14107 N.E. Airport Way
Portland, OR 97230
Tel: (503) 252-9299
FAX: (503) 252-9253

SMC Pneumatics Inc. (Cincinnati)
4598 Olympic Blvd.
Erlanger, KY 41018
Tel: (606) 647-5600
FAX: (606) 647-5609

SMC Pneumatics Inc. (L.A.)
14191 Myford Road
Tustin, CA 92780
Tel: (714) 669-1701
FAX: (714) 669-1715

SMC Pneumatics Inc. (Richmond)
5377 Glen Alden Drive
Richmond, VA 23231
Tel: (804) 222-2762
FAX: (804) 222-5221

SMC Pneumatics Inc. (Cleveland)
2305 East Aurora Road
Twinsburg, OH 44087
Tel: (330) 963-2727
FAX: (330) 963-2730

SMC Pneumatics Inc. (Milwaukee)
16850 W. Victor Road
New Berlin, WI 53151
Tel: (414) 827-0080
FAX: (414) 827-0092

SMC Pneumatics Inc. (Rochester)
245 Summit Point Drive
Henrietta, NY 14487
Tel: (716) 321-1300
FAX: (716) 321-1865

Europe
ENGLAND
SMC Pneumatics (U.K.) Ltd.
GERMANY
SMC Pneumatik GmbH
ITALY
SMC Italia SpA
FRANCE
SMC Pneumatique SA
HOLLAND
SMC Controls BV
SWEDEN
SMC Pneumatics Sweden AB
SWITZERLAND
SMC Pneumatik AG
AUSTRIA
SMC Pneumatik GmbH
SPAIN
SMC España, S.A.
IRELAND
SMC Pneumatics (Ireland) Ltd.
Asia
JAPAN

SMC Corporation
KOREA
SMC Pneumatics Korea Co., Ltd.
CHINA
SMC (China) Co., Ltd.
HONG KONG
SMC Pneumatics (Hong Kong) Ltd.
SINGAPORE
SMC Pneumatics (S.E.A.) Pte. Ltd.
PHILIPPINES
SMC Pneumatics (Philippines), Inc.
MALAYSIA
SMC Pneumatics (S.E.A.) Sdn. Bhd.
TAIWAN
SMC Pneumatics (Taiwan) Co., Ltd.
THAILAND
SMC Thailand Ltd.
INDIA
SMC Pneumatics (India) Pvt., Ltd.
North America
CANADA
SMC Pneumatics (Canada) Ltd.
MEXICO
SMC Pneumatics (Mexico) S.A. de C.V.

South America
ARGENTINA
SMC Argentina S.A.
CHILE
SMC Pneumatics (Chile) Ltda.

Oceania
AUSTRALIA
SMC Pneumatics (Australia) Pty. Ltd.
NEW ZEALAND
SMC Pneumatics (N.Z.) Ltd.

SMC offers the same quality and engineering expertise in many other pneumatic components

Valves
Directional Control Valves
Manual Valves
Mufflers
Exhaust Cleaners
Quick Exhaust Valves

Valves
Proportional Valves
Mechanical Valves
Miniature Valves
Fluid Valves

Cylinders/Actuators
Compact Cylinders
Miniature Cylinders
Rodless Cylinders
Rotary Actuators
Pneumatic Grippers

Vacuum
Vacuum Ejectors
Vacuum Accessories
Instrumentation
Pneumatic Positioners
Pneumatic Transducers

Air Preparation Equipment
Filters-Regulators-Lubricators
Coalescing Filters
Micro Mist Separators
Fittings
Air Fittings

SMC Pneumatics Inc.

P.O. Box 26640, Indianapolis, IN 46226
Tel: (317) 899-4440 • FAX: (317) 899-3102