

Round Type Hydraulic Cylinder

CHM Series

CHQ

CHK

CHN

CHM

CHS

CH2

CHA

Related
Products

D-

CHM Series



Nominal pressure: **3.5 MPa**

Bore size (mm): 20, 25, 32, 40

Round Type Hydraulic Cylinder

CH□M Series

3.5 MPa

ø20, ø25, ø32, ø40

How to Order

CHM **L** **25** - **100**

With Auto Switch CHDM **L** **25** - **100** - **M9BW** □ - **C**

With auto switch (built-in magnet)

Mounting type

B	Basic type
L	Axial foot type
F	Rod flange type
G	Head flange type
C	Single clevis type

Bore size

20	20 mm
25	25 mm
32	32 mm
40	40 mm

Cylinder stroke (mm)

Refer to the standard stroke table on page 317.

Number of auto switches

Nil	2 pcs.
S	1 pc.
n	"n" pcs.

Auto switch type

Nil	Without auto switch
------------	---------------------

* Select applicable auto switch models from the table below.

Auto switch mounting bracket ^(Note)

Note) This symbol is indicated when the D-A9□ or M9□ type auto switch is specified. This mounting bracket does not apply to other auto switches (D-C7□ and H7□, etc.).

Built-in Magnet Cylinder Model

If a built-in magnet cylinder without auto switch is required, there is no need to enter the symbol for the auto switch. (Example) CHDMB20-100

Applicable Auto Switches/Refer to pages 431 to 490 for further details on each auto switch.

Type	Special function	Electrical entry	Indicator light	Wiring (output)	Load voltage		Auto switch model		Lead wire length (m)					Pre-wired connector	Applicable load		
					DC	AC	Perpendicular	In-line	0.5 (Nil)	1 (M)	3 (L)	5 (Z)	None (N)				
Solid state auto switch	—	Grommet	—	3-wire (NPN)	5 V, 12 V	—	M9NV	M9N	●	—	●	○	—	○	IC circuit		
				3-wire (PNP)			M9PV	M9P	●	—	●	○	—	○			
		2-wire	M9BV	M9B	●	—	●	○	—	○	—						
		—	H7C	●	—	●	○	—	○								
	Diagnostic indication (2-color indicator)	Terminal conduit	—	—	3-wire (NPN)	5 V, 12 V	—	—	G39	—	—	—	—	—	—	IC circuit	
					2-wire			—	K39	—	—	—	—	—	—		
	Water resistant (2-color indicator)	Grommet	—	Yes	3-wire (NPN)	24 V	—	M9N WV	M9N WV	●	●	●	○	—	○	Relay PLC	
					3-wire (PNP)			M9P WV	M9P WV	●	●	●	○	—	○		
					2-wire	M9B WV	M9B WV	●	●	●	○	—	○				
					3-wire (NPN)	M9NAV ^{*1}	M9NA ^{*1}	○	○	●	○	—	○				
3-wire (PNP)					M9PAV ^{*1}	M9PA ^{*1}	○	○	●	○	—	○					
2-wire					M9BAV ^{*1}	M9BA ^{*1}	○	○	●	○	—	○					
Diagnostic output (2-color indicator)	Grommet	—	—	4-wire (NPN)	5 V, 12 V	—	—	H7NF	●	—	●	○	—	○	IC circuit		
				3-wire (NPN) equiv.			—	A96V	A96	●	—	●	○	—		○	
Reed auto switch	—	Grommet	Yes	—	5 V	—	A96V	A96	●	—	●	○	—	○	IC circuit		
							A93V ^{*2}	A93	●	●	●	○	—	○			
							A90V	A90	●	—	●	○	—	○			
							—	B54	●	—	●	○	—	○			
							—	B64	●	—	●	○	—	○			
							—	C73C	●	—	●	○	—	○			
							—	C80C	●	—	●	○	—	○			
							—	A33	—	—	—	—	●	—		—	PLC
							—	A34	—	—	—	—	●	—		—	
							Diagnostic indication (2-color indicator)	Terminal conduit	—	Yes	—	100 V, 200 V	—	—		A44	—
—	B59W	●	—	●	○	—								○			

*1 Water resistant type auto switches can be mounted on the above models, but in such case SMC cannot guarantee water resistance.

Consult with SMC regarding water resistant types with the above model numbers.

* Lead wire length symbols: 0.5 m Nil (Example) M9NV
 1 m M (Example) M9N WV
 3 m L (Example) M9N WL
 5 m Z (Example) M9N WZ
 None N (Example) H7CN

* Solid state auto switches marked "○" are produced upon receipt of order.

* Do not indicate lead wire length symbol N (none) for types D-A3□, D-A44, D-G-39 or D-K39.

* Since there are applicable auto switches other than listed, refer to page 326 for details.

* For details about auto switches with pre-wired connector, refer to pages 474 and 475.

* D-A9□, M9□, M9□W, M9□A are shipped together (but not assembled). (Only auto switch mounting brackets are assembled at the time of shipment.)

Specifications



Bore size (mm)	20	25	32	40
Action	Double acting/Single rod			
Fluid	Hydraulic fluid			
Nominal pressure	3.5 MPa			
Proof pressure	5.0 MPa			
Maximum allowable pressure	3.5 MPa			
Minimum operating pressure	0.3 MPa			
Ambient and fluid temperature	Without auto switch: -10° to 80°C			
	With auto switch: -10° to 60°C			
Piston speed	8 to 300 mm/s			
Cushion	None			
Stroke length tolerance	to 250 mm $\begin{matrix} +1.0 \\ 0 \end{matrix}$			
	250 to 800 mm $\begin{matrix} +1.4 \\ 0 \end{matrix}$			
Mounting type	Basic type, Axial foot type Head flange type, Rod flange type Single clevis type			

Note) Refer to page 214 for definitions of terms related to pressure.

Accessories

Mounting bracket	Basic type	Axial foot type	Head flange type	Rod flange type	Single clevis type	
Standard	Mounting nut	● (2 pcs.)	● (2 pcs.)	● (1 pc.)	● (1 pc.)	—
	Rod end nut	●	●	●	●	●

Optional

I-type single knuckle joint Y-type double knuckle joint Bracket for clevis type Knuckle pin Bracket pin	Refer to page 323
---	-------------------

Hydraulic Fluid Compatibility

Hydraulic fluid	Compatibility
Standard mineral hydraulic fluid	Compatible
W/O hydraulic fluid	Compatible
O/W hydraulic fluid	Compatible
Water/Glycol hydraulic fluid	Not compatible
Phosphate hydraulic fluid	Not compatible

Standard Strokes: Refer to page 325 regarding minimum strokes for auto switch mounting.

Bore size (mm)	Standard strokes (mm)
20	25 to 800
25	
32	
40	

* Orders of the standard strokes above can be supplied with a minimum lead time.
Please consult with SMC regarding the manufacture of strokes other than the above.

Mounting Brackets: Part Nos.

Bore size (mm)	20	25	32	40
Axial foot*	CHM-L020	CHM-L025	CHM-L032	CHM-L040
Flange	CHM-F020	CHM-F025	CHM-F032	CHM-F040

* When ordering the axial foot type, order 2 pcs. for each cylinder.

CHQ

CHK□

CHN

CHM

CHS□

CH2□

CHA

Related Products

D-□

Theoretical Output

Bore size (mm)	Rod size (mm)	Operating direction	Piston area (mm ²)	Operating pressure (MPa)					Unit: N
				1	1.5	2	2.5	3	
20	10	OUT	314	314	471	628	785	942	1099
		IN	235	235	352	470	587	705	822
25	12	OUT	490	490	735	980	1225	1470	1715
		IN	377	377	565	754	942	1131	1319
32	16	OUT	804	804	1206	1608	2010	2412	2814
		IN	603	603	904	1206	1507	1809	2110
40	18	OUT	1256	1256	1884	2512	3140	3768	4396
		IN	1002	1002	1503	2004	2505	3006	3507

Theoretical output (N) = Pressure (MPa) x Piston area (mm²)

Weight

		Unit: kg			
Bore size (mm)		20	25	32	40
Basic weight	Basic type	0.20	0.29	0.50	0.82
	Axial foot type	0.44	0.55	0.88	1.36
	Flange type	0.29	0.46	0.69	1.03
	Clevis type	0.18	0.37	0.64	0.77
Additional weight per 50 mm		0.06	0.08	0.12	0.16

- Calculation method (Example) **CHML20-100** (Foot type ø20/100 mm stroke)
 - Basic weight.....0.44 kg
 - Additional weight---0.06/50 mm
 - Cylinder stroke.....100 mm
 - 0.44 + 0.06 x 100/50 = 0.56 kg

Specific Product Precautions

Be sure to read this before handling the products.
Refer to back page 50 for Safety Instructions and pages 214 to 221 for Hydraulic Cylinder and Auto Switch Precautions.

Air Release

Caution

1. Since CH□M series does not have an air release valve, release air from components other than the cylinder (e.g. from piping, etc.).
2. When operating a cylinder for the first time, be sure to release the air at low pressure. When the air release is complete, operate the cylinder at reduced pressure, then gradually increase it to the normal operating pressure. However, the piston speed at this time should be adjusted to the minimum speed.

Mounting

Caution

1. When mounting with bracket mounting nuts, tighten them using the tightening torques in the table below as a guide.

Bore size (mm)	Mounting nut thread	Mounting nut width across flats (mm)	Tightening torque (N·m)
20	M22 x 1.5	26	45
25	M24 x 1.5	32	60
32	M30 x 1.5	38	85
40	M33 x 1.5	41	110

2. When mounted with one side attached and one side free (basic type, flange type) and operating at high speed, the bending moment acts on the cylinder due to oscillation at the stroke end, which may cause cylinder damage. In this type of situation, install brackets to suppress the oscillation of the cylinder body, or reduce the piston speed enough so that the cylinder body does not oscillate at the stroke end.

Construction

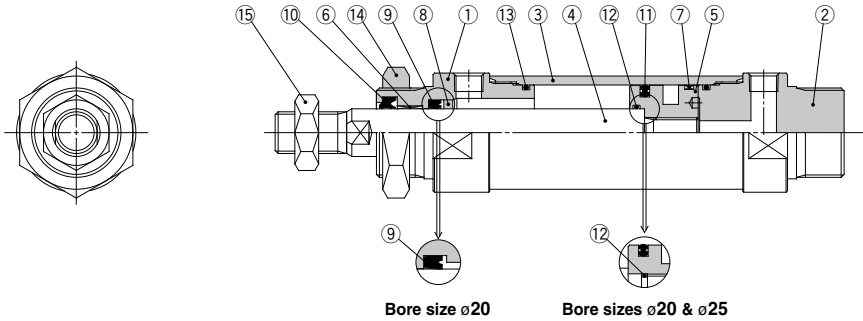

CHQ
CHK□
CHN
CHM
CHS□
CH2□
CHA
Related Products
D-□

Parts List

No.	Description	Material	Note
1	Rod cover	Aluminum alloy	Hard black anodized
2	Head cover	Aluminum alloy	Hard black anodized
3	Cylinder tube	Aluminum alloy	Hard anodized
4	Piston rod	Carbon steel	Hard chromium electroplated*
5	Piston	Aluminum alloy	Chromated
6	Bushing	Oil impregnated alloy	
7	Wear ring	Resin	
8	Retainer	Copper alloy	
9	Rod seal	NBR	
10	Wiper ring	NBR	
11	Piston seal	NBR	
12	Piston gasket	NBR	
13	Tube gasket	NBR	
14	Mounting nut	Carbon steel	Black zinc chromated
15	Rod end nut	Rolled steel	Nickel plated

* In case of cylinder bore sizes ø20 and ø25 for built-in magnet type, the piston rod material is stainless steel when equipped with auto switches.

Dimensions

Basic type: CHMB

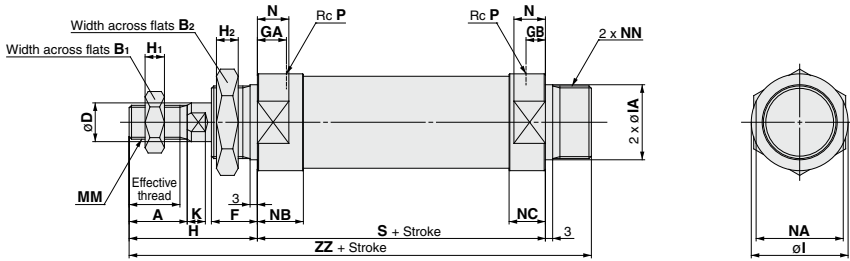

Bore size (mm)	Stroke range (mm)	Effective thread length (mm)	A	B ₁	B ₂	D	F	GA	GB	H	H ₁	H ₂	I	K	MM	P	S	NN	N	NA	NB	NC	ZZ	
20	Up to 800	15.5	18	13	26	10	16	12	8	41	5	8	30	23 18 ^{+0.020} _{-0.053}	5	M8 x 1.25	1/8	81	M22 x 1.5	13	26	19	15	138
25	Up to 800	19.5	22	17	32	12	16	12	8	46	6	8	32	25 18 ^{+0.020} _{-0.053}	5.5	M10 x 1.25	1/8	81	M24 x 1.5	13	28	19	15	143
32	Up to 800	21	24	22	38	16	19	12	8	53	8	9	40	31 18 ^{+0.025} _{-0.064}	7.5	M14 x 1.5	1/8	87	M30 x 1.5	13	36	19	15	159
40	Up to 800	21	24	24	41	18	21	14	11	54	10	11	48	34 18 ^{+0.025} _{-0.064}	7.5	M16 x 1.5	1/4	108	M33 x 2	19	44	24	21	183

Axial foot type: CHML

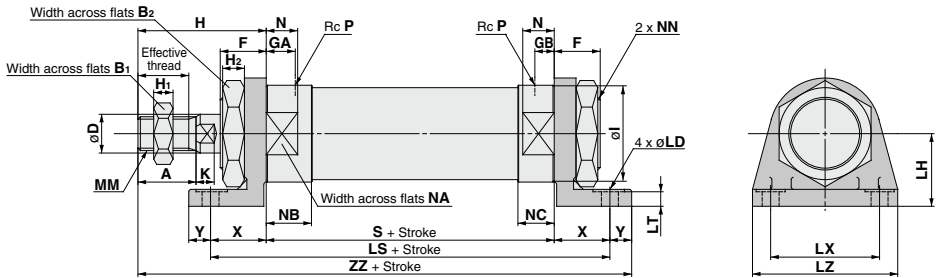

Bore size (mm)	Stroke range (mm)	Effective thread length (mm)	A	B ₁	B ₂	D	F	GA	GB	H	H ₁	H ₂	I	K	LD	LH	LS	LT	LX	LZ	MM	N	NA	NB	NC
20	Up to 800	15.5	18	13	26	10	16	12	8	41	5	8	30	5	7	25	121	5.5	40	55	M8 x 1.25	13	26	19	15
25	Up to 800	19.5	22	17	32	12	16	12	8	46	6	8	32	5.5	7	28	121	5.5	40	55	M10 x 1.25	13	28	19	15
32	Up to 800	21	24	22	38	16	19	12	8	53	8	9	40	7.5	7	30	133	6	45	60	M14 x 1.5	13	36	19	15
40	Up to 800	21	24	24	41	18	21	14	11	54	10	11	48	7.5	9	35	158	6	55	75	M16 x 1.5	19	44	24	21

(mm)

* Foot bracket plate thickness is dimension LT + 1 mm.

Bore size (mm)	NN	P	S	X	Y	ZZ
20	M22 x 1.5	1/8	81	20	9	151
25	M24 x 1.5	1/8	81	20	9	156
32	M30 x 1.5	1/8	87	23	9	172
40	M33 x 2	1/4	108	25	11	198

Rod flange type: **CHMF**

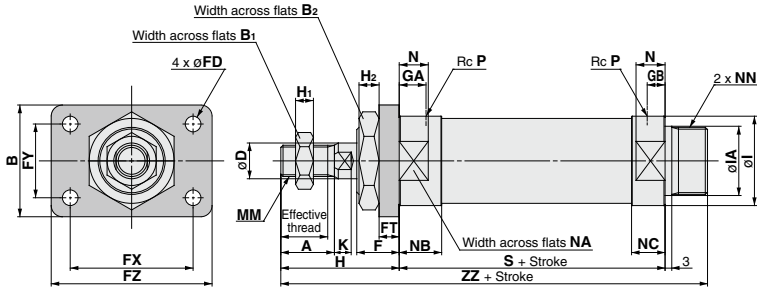

(mm)

Bore size (mm)	Stroke range (mm)	Effective thread length (mm)	A	B	B ₁	B ₂	D	F	FD	FT	FX	FY	FZ	GA	GB	H	H ₁	H ₂	I	IA (tolerance)	K	MM	N	NA
20	Up to 800	15.5	18	38	13	26	10	16	7	6	51	21	68	12	8	41	5	8	30	23 f8 ^{+0.020} _{-0.053}	5	M8 x 1.25	13	26
25	Up to 800	19.5	22	44	17	32	12	16	7	9	53	27	70	12	8	46	6	8	32	25 f8 ^{+0.020} _{-0.053}	5.5	M10 x 1.25	13	28
32	Up to 800	21	24	50	22	38	16	19	7	9	55	33	72	12	8	53	8	9	40	31 f8 ^{+0.025} _{-0.064}	7.5	M14 x 1.5	13	36
40	Up to 800	21	24	60	24	41	18	21	9	9	66	36	84	14	11	54	10	11	48	34 f8 ^{+0.025} _{-0.064}	7.5	M16 x 1.5	19	44

(mm)

Bore size (mm)	NB	NC	NN	P	S	ZZ
20	19	15	M22 x 1.5	1/8	81	138
25	19	15	M24 x 1.5	1/8	81	143
32	19	15	M30 x 1.5	1/8	87	159
40	24	21	M33 x 2	1/4	108	183

CHQ

CHK □

CHN

CHM

CHS □

CH2 □

CHA

Related Products

D □

Dimensions

Head flange type: CHMG

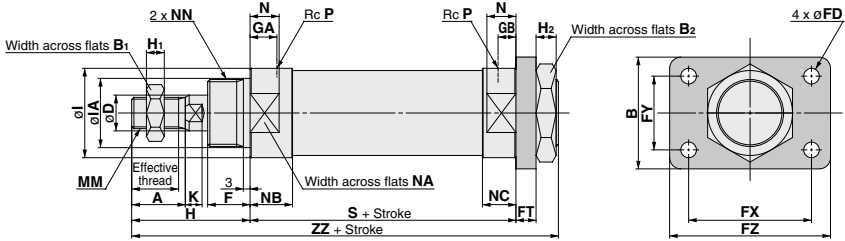

Bore size (mm)	Stroke range (mm)	Effective thread length (mm)	A	B	B ₁	B ₂	D	F	FD	FT	FX	FY	FZ	GA	GB	H	H ₁	H ₂	I	IA (tolerance)	K	MM	N	NA
20	Up to 800	15.5	18	38	13	26	10	16	7	6	51	21	68	12	8	41	5	8	30	23 f8 ^{+0.020} _{-0.053}	5	M8 x 1.25	13	26
25	Up to 800	19.5	22	44	17	32	12	16	7	9	53	27	70	12	8	46	6	8	32	25 f8 ^{+0.020} _{-0.053}	5.5	M10 x 1.25	13	28
32	Up to 800	21	24	50	22	38	16	19	7	9	55	33	72	12	8	53	8	9	40	31 f8 ^{+0.025} _{-0.064}	7.5	M14 x 1.5	13	36
40	Up to 800	21	24	60	24	41	18	21	9	9	66	36	84	14	11	54	10	11	48	34 f8 ^{+0.025} _{-0.064}	7.5	M16 x 1.5	19	44

(mm)

Bore size (mm)	NB	NC	NN	P	S	ZZ
20	19	15	M22 x 1.5	1/8	81	138
25	19	15	M24 x 1.5	1/8	81	143
32	19	15	M30 x 1.5	1/8	87	159
40	24	21	M33 x 2	1/4	108	183

Single clevis type: CHMC

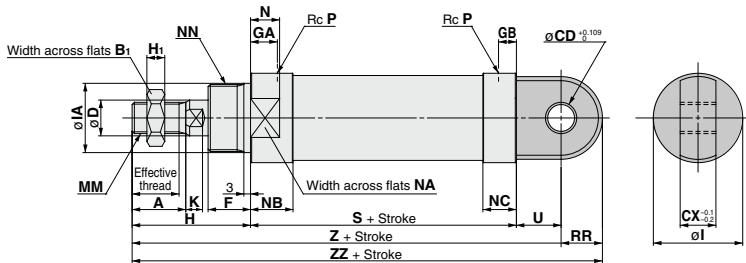

Bore size (mm)	Stroke range (mm)	Effective thread length (mm)	A	B ₁	CD	CX	D	F	GA	GB	H	H ₁	I	IA (tolerance)	K	MM	N	NA	NB	NC	NN	P	RR	S	U	Z	ZZ
20	Up to 800	15.5	18	13	10	16	10	16	12	8	41	5	30	23 f8 ^{+0.020} _{-0.053}	5	M8 x 1.25	13	26	19	15	M22 x 1.5	1/8	13.5	81	14	136	149.5
25	Up to 800	19.5	22	17	10	16	12	16	12	8	46	6	32	25 f8 ^{+0.020} _{-0.053}	5.5	M10 x 1.25	13	28	19	15	M24 x 1.5	1/8	14.5	81	15	142	156.5
32	Up to 800	21	24	22	12	16	19	12	8	53	8	40	31 f8 ^{+0.025} _{-0.064}	7.5	M14 x 1.5	13	36	19	15	M30 x 1.5	1/8	18.5	87	20	160	178.5	
40	Up to 800	21	24	24	12	24	18	21	14	11	54	10	48	34 f8 ^{+0.025} _{-0.064}	7.5	M16 x 1.5	19	44	24	21	M33 x 2	1/4	22.5	108	20	182	204.5

Accessories (Standard)

Rod end nut

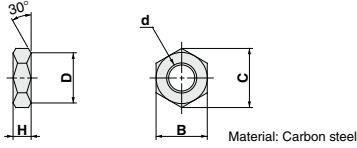

Part no.	Applicable bore size (mm)	d	H	B	C	D
NT-02	20	M8 x 1.25	5	13	15.0	12.5
NT-03	25	M10 x 1.25	6	17	19.6	16.5
NT-04	32	M14 x 1.5	8	22	25.4	21.0
AC-NI-50	40	M16 x 1.5	10	24	27.7	23

Mounting nut

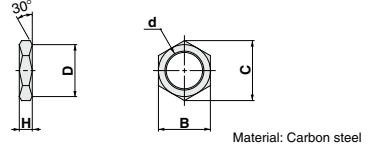

Part no.	Applicable bore size (mm)	d	H	B	C	D
SO-02	20	M22 x 1.5	8	26	30	26
SO-03	25	M24 x 1.5	8	32	36.9	32
SO-04	32	M30 x 1.5	9	38	43.9	38
SO-05	40	M33 x 2.0	11	41	47.3	41

Accessory Brackets (Optional)

I-type single knuckle joint

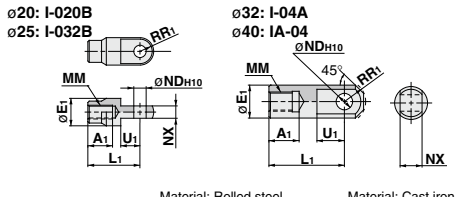

Part no.	Applicable bore size (mm)	A1	E1	L1	MM	R1	U1	NDH ¹⁰	NX
I-020B	20	16	20	36	M8 x 1.25	10	14	9 ^{+0.058} ₀	9 ^{-0.1} _{-0.2}
I-032B	25	18	20	38	M10 x 1.25	10	14	9 ^{+0.058} ₀	9 ^{-0.1} _{-0.2}
I-04A	32	22	24	55	M14 x 1.5	15.5	20	12 ^{+0.070} ₀	16 ^{-0.1} _{-0.3}
IA-04	40	22	24	55	M16 x 1.5	15.5	20	12 ^{+0.070} ₀	16 ^{-0.1} _{-0.3}

Bracket

4 x J counter bore * Order bracket pin separately.

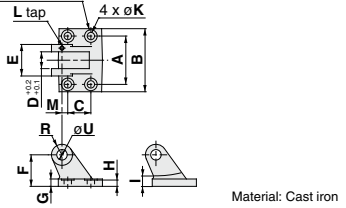

Part no.	Applicable bore size (mm)	A	B	C	D	U (H8)	E	F	G	H	I	J	K	L	M	R	Note
AD-FI-20	20	46	60	22	16	10 ^{+0.027} ₀	30	28	65	55	10	12	7	M4	5.5	10	M4 set screw
AD-FI-25	25	46	60	22	16	10 ^{+0.027} ₀	30	30	65	55	10	12	7	M4	5.5	10	(1 pc.)
AD-FI-32	32	56	80	30	16	12 ^{+0.027} ₀	36	40	10	9	13	12	7	M5	7	12	M5 set screw
AD-FI-40	40	64	88	30	24	12 ^{+0.027} ₀	44	43	10	9	13	16	9	M5	10	12	(1 pc.)

Y-type double knuckle joint

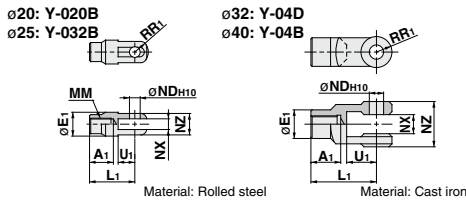

Part no.	Applicable bore size (mm)	A1	E1	L1	MM	R1	U1	NDH ¹⁰	NX	NZ	Note
Y-020B	20	16	20	36	M8 x 1.25	5	14	9 ^{+0.058} ₀	9 ^{+0.2} _{+0.1}	18	With CDP-1
Y-032B	25	18	20	38	M10 x 1.25	5	14	9 ^{+0.058} ₀	9 ^{+0.2} _{+0.1}	18	With CDP-1
Y-04D	32	22	24	55	M14 x 1.5	13	25	12 ^{+0.070} ₀	16 ^{+0.3} _{+0.3}	38	With CDP-3
Y-04B	40	22	24	55	M16 x 1.5	13	25	12 ^{+0.070} ₀	16 ^{+0.3} _{+0.3}	38	With CDP-3

Bracket pin

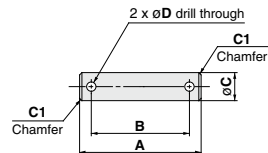

Part no.	Applicable bore size (mm)	A	B	C (f8)		D	Note
				Size	Tolerance		
AD-EI-20	20	45.5	35.5	10	-0.013 -0.035	3.2	Cotter pin ø3.2 x 15 ℓ (2 pcs.)
AD-EI-25	25	45.5	35.5	10	-0.015 -0.035	3.2	
AD-EI-32	32	52	42	12	-0.018 -0.045	4	Cotter pin
AD-EI-40	40	60	50	12	-0.018 -0.045	4	ø4 x 20 ℓ (2 pcs.)

Clevis pin & Knuckle pin

Bore size: ø20 & ø25

Part no.: CDP-1

Material: Carbon steel

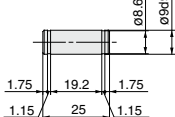

Bore size: ø32 & ø40

Part no.: CDP-3

Material: Carbon steel

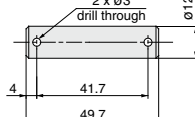

Retaining ring: C type, ø9 size for shaft

Cotter pin: ø3 x 18 ℓ (2 pcs.)

CH□M Series Auto Switch Mounting

Refer to pages 431 to 490 for detailed specifications.

Auto Switches: Proper Mounting Positions and Mounting Heights for Stroke End Detection

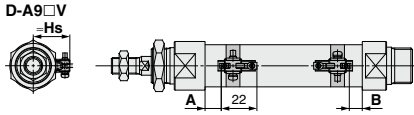

A and B are the dimensions from the end of the head cover/rod cover to the end of the auto switch.

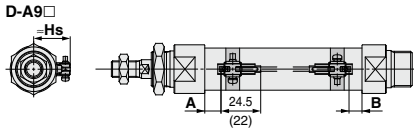

A and B are the dimensions from the end of the head cover/rod cover to the end of the auto switch.
* Values inside () are for D-M9□AV.

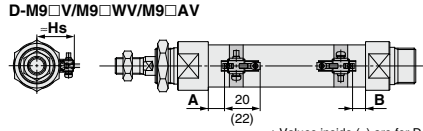

A and B are the dimensions from the end of the head cover/rod cover to the end of the auto switch.
* Values inside () are for D-M9□AV.

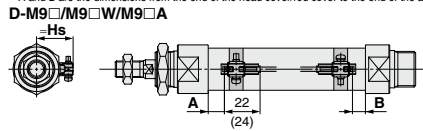

A and B are the dimensions from the end of the head cover/rod cover to the end of the auto switch.
* Values inside () are for D-M9□AV.

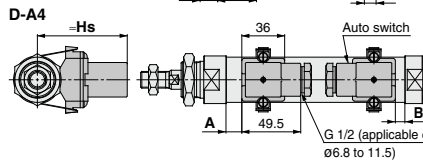
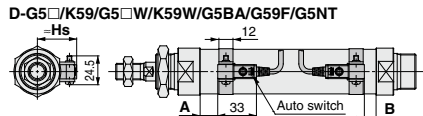
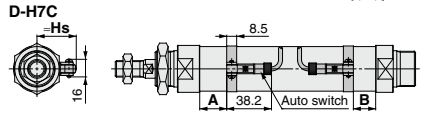
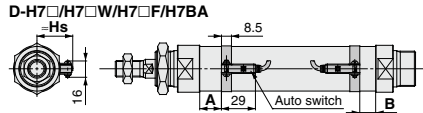
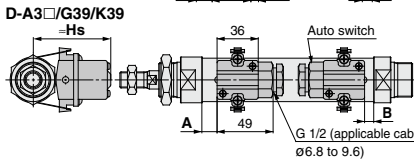
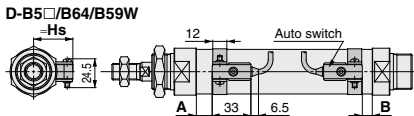
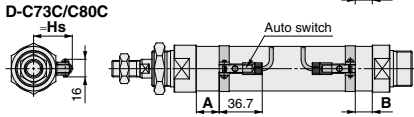
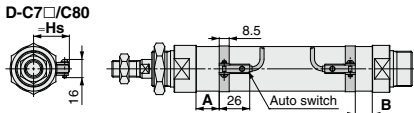

Auto Switch Proper Mounting Positions

Bore size (mm)	Solid state auto switch								Reed auto switch									
	D-M9□(V) D-M9□W(V) D-M9□A(V)		D-H7□ D-H7□W/H7C D-H7NF/H7BA		D-G5□/K59 D-G5□W/K59W D-G59F/G5BA D-G5NT		D-G39/K39		D-A9□(V)		D-C7□/C80 D-C73C/C80C		D-B5□/B64		D-B59W		D-A3□/A44	
	A	B	A	B	A	B	A	B	A	B	A	B	A	B	A	B	A	B
20	18	17	13.5	12.5	10	9	8	7	14	13	14.5	13.5	8.5	7.5	11.5	10.5	8	7
25	16	19	11.5	14.5	8	11	6	9	12	15	12.5	15.5	6.5	9.5	9.5	12.5	6	9
32	23	18	18.5	13.5	15	10	13	8	19	14	19.5	14.5	13.5	8.5	16	11.5	13	8
40	27.5	23.5	23	19	19.5	15.5	17.5	13.5	23.5	19.5	24	20	18	14	21	17	17.5	13.5

Note) When setting an auto switch, be sure to check its operation before adjusting.

Auto Switch Mounting Heights

Bore size (mm)	D-M9□(V) D-M9□W(V) D-M9□A(V) D-A9□(V)		D-H7□/H7□W D-H7NF/H7BA D-C7□/C80		D-C73C/C80C		D-G5□/K59 D-G5□W/K59W D-G59F/G5BA D-G5NT/H7C D-B5□/B64 D-B59W		D-G39/K39 D-A3□		D-A44	
	Hs		Hs		Hs		Hs		Hs		Hs	
20	26		25.5		27		27.5		62		72	
25	28.5		28		29.5		30		64.5		74.5	
32	32		31.5		33		33.5		68		78	
40	36.5		36		37.5		38		72.5		82.5	

Minimum Auto Switch Mounting Stroke

Auto switch model	Number of auto switches mounted (mm)				
	1 pc.	2 pcs.		n pcs.	
		Different surfaces	Same surface	Different surfaces	Same surface
D-M9□	5	20	55	$20 + 35 \frac{(n-2)}{2}$ (n = 2, 4, 6...) <small>Note 3)</small>	$55 + 35 (n-2)$ (n = 2, 3, 4, 5...)
D-M9□W	10	20	55	$20 + 35 \frac{(n-2)}{2}$ (n = 2, 4, 6...) <small>Note 3)</small>	$55 + 35 (n-2)$ (n = 2, 3, 4, 5...)
D-M9□A	10	25	60	$25 + 35 \frac{(n-2)}{2}$ (n = 2, 4, 6...) <small>Note 3)</small>	$60 + 35 (n-2)$ (n = 2, 3, 4, 5...)
D-A9□	5	15	50	$15 + 35 \frac{(n-2)}{2}$ (n = 2, 4, 6...) <small>Note 3)</small>	$50 + 35 (n-2)$ (n = 2, 3, 4, 5...)
D-M9□V	5	20	35	$20 + 35 \frac{(n-2)}{2}$ (n = 2, 4, 6...) <small>Note 3)</small>	$35 + 35 (n-2)$ (n = 2, 3, 4, 5...)
D-A9□V	5	15	25	$15 + 35 \frac{(n-2)}{2}$ (n = 2, 4, 6...) <small>Note 3)</small>	$25 + 35 (n-2)$ (n = 2, 3, 4, 5...)
D-M9□WV D-M9□AV	10	20	35	$20 + 35 \frac{(n-2)}{2}$ (n = 2, 4, 6...) <small>Note 3)</small>	$35 + 35 (n-2)$ (n = 2, 3, 4, 5...)
D-H7□/H7□W D-H7NF/H7BA	10	15	60	$15 + 45 \frac{(n-2)}{2}$ (n = 2, 4, 6...) <small>Note 3)</small>	$60 + 45 (n-2)$ (n = 2, 3, 4, 5...)
D-C7□ D-C80	10	15	50	$15 + 45 \frac{(n-2)}{2}$ (n = 2, 4, 6...) <small>Note 3)</small>	$50 + 45 (n-2)$ (n = 2, 3, 4, 5...)
D-H7C D-C73C D-C80C	10	15	65	$15 + 50 \frac{(n-2)}{2}$ (n = 2, 4, 6...) <small>Note 3)</small>	$65 + 50 (n-2)$ (n = 2, 3, 4, 5...)
D-G5□/K59 D-G5□W/K59W D-G59F/G5BA/G5NT D-B5□/B64	10	15	75	$15 + 50 \frac{(n-2)}{2}$ (n = 2, 4, 6...) <small>Note 3)</small>	$75 + 55 (n-2)$ (n = 2, 3, 4, 5...)
D-B59W	15	20	75	$20 + 50 \frac{(n-2)}{2}$ (n = 2, 4, 6...) <small>Note 3)</small>	$75 + 55 (n-2)$ (n = 2, 3, 4, 5...)
D-G39/K39 D-A3□/A44	10	35	100	$35 + 30 (n-2)$ (n = 2, 3, 4, 5...)	$100 + 100 (n-2)$ (n = 2, 3, 4, 5...)

Note 3) When "n" is an odd number, an even number that is one larger than this odd number is used for the calculation.

Note 1) Auto switch mounting

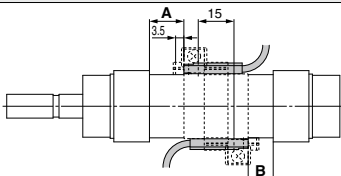
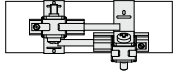
Auto switch model	Auto switches → 2 pcs.	
	Different surfaces	Same surface
	 <p>Correct auto switch mounting position is 3.5 mm from the back face of the switch holder.</p>	 <p>Mount auto switches offset (in circumferential direction of cylinder tube) so that auto switch units and lead wires do not run up against each other.</p>
D-M9□ D-M9□W	Less than 20 stroke <small>Note 2)</small>	Less than 55 stroke <small>Note 2)</small>
D-M9□A	Less than 25 stroke <small>Note 2)</small>	Less than 60 stroke <small>Note 2)</small>
D-A9□	—	Less than 50 stroke <small>Note 2)</small>

Note 2) Minimum stroke for auto switch mounting in types other than those mentioned in Note 1.

Operating Range

Auto switch model	Bore size (mm)			
	20	25	32	40
D-M9□(V) D-M9□W(V) D-M9□A(V)	4.5	6.5	4.5	6.5
D-H7□/H7C D-H7□W D-H7NF/H7BA	4.5	5.5	5	5.5
D-G5□/K59/G59F D-G5□W/K59W D-G5BA/G5NT	5	5	5	5.5

Auto switch model	Bore size (mm)			
	20	25	32	40
D-G39/K39	9	8.5	10	10.5
D-A9□(V)	7	6	8	8
D-C7□/C80 D-C73C/C80C	8	10	9	10
D-B5□/B64	8	10	9	10
D-B59W	13	13	14	14
D-A3□/A44	9	10	10	11

* Since this is a guideline including hysteresis, not meant to be guaranteed. (Assuming approximately ±30% dispersion.) There may be the case it will vary substantially depending on an ambient environment.

Auto Switch Mounting Brackets: Part Nos.

Auto switch model	Bore size (mm)			
	φ20	φ25	φ32	φ40
D-A9□(V) D-M9□(V) D-M9□W(V)	Note 1) BMA3-020	Note 1) BMA3-025	Note 1) BMA3-032	Note 1) BMA3-040
D-M9□A(V)	Note 2) BMA3-020S	Note 2) BMA3-025S	Note 2) BMA3-032S	Note 2) BMA3-040S
D-H7□ D-H7□W D-H7NF D-H7BA D-C7□/C80 D-C73C/C80C	BMA2-020A	BMA2-025A	BMA2-032A	BMA2-040A
D-G5□/G5□W D-G59F D-G5BA/G5NT D-B5□/B64 D-B59W	BA-01	BA-02	BA-32	BA-04
D-G39/K39 D-A3□/A44	BD1-01M	BD1-02M	BD1-02	BD1-04M

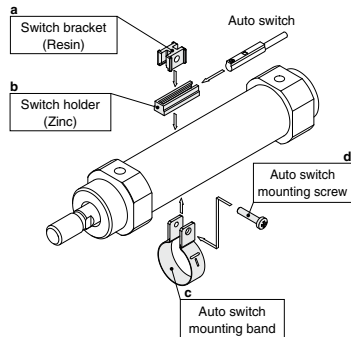

Note 1) Set part number which includes the auto switch mounting band (BMA2-□□□A) and the holder kit (BJ5-1/Switch bracket: Transparent).

Since the switch bracket (made from nylon) are affected in an environment where alcohol, chloroform, methylamines, hydrochloric acid or sulfuric acid is splashed over, so it cannot be used. Please consult SMC regarding other chemicals.

Note 2) Set part number which includes the auto switch mounting band, stainless steel screw and the holder kit (BJ4-1/Switch bracket: White).

Note 3) For the D-M9□A(V) type auto switch, do not install the switch bracket on the indicator light.

(1) BJ□-1 is a set of "a" and "b".

(2) BM2-□□□A(S) is a set of "c" and "d".
Band (c) is mounted so that the projected part is on the internal side (contact side with the tube).
BJ4-1 (Switch bracket: White)
BJ5-1 (Switch bracket: Transparent)

[Stainless steel mounting screw kits]

The following stainless steel mounting screw kits are available for use depending on the operating environment. (Switch mounting bands are not included and should be ordered separately.)

BBA3: D-G5, K5, B5, B6

BBA4: D-C7, C8, H7

Note) Refer to the table below for details on BBA3, BBA4.

The above stainless steel screws are used when a cylinder is shipped with the D-G5BA auto switches.

When only an auto switch is shipped independently, the BBA3 or BBA4 is attached.

Stainless mounting screw kit details

Part no.	Contents			Applicable auto switch mounting bracket part nos.	Applicable auto switches
	Description	Size	Pcs.		
BBA3	Auto switch mounting screws	M4 x 0.7 x 22L	1	BA-01, BA-02, BA-32, BA-04, BA-05, BA-06, BA-08, BA-10	D-B5, B6 D-G5, K5
				BA2-020, BA2-025, BA2-032, BA2-040	
				BA5-050, BHN2-025, BSG1-032	
				BH2-040, BH2-050, BH2-080, BH2-100	
				BAF-32, BAF-04, BAF-05, BAF-06, BAF-08, BAF-10	
BBA4	Auto switch mounting screws	M3 x 0.5 x 14L	1	BJ2-006, BJ2-010, BJ2-016	D-C7, C8 D-H7
				BM2-020A, BM2-025A, BM2-032A, BM2-040A	
				BMA2-020A, BMA2-025A, BMA2-032A, BMA2-040A, BMA2-050A, BMA2-063A	
				BHN3-025A, BHN3-032A, BHN3-040A	

Besides the models listed in "How to Order," the following auto switches are applicable.

Refer to pages 431 to 490 for detailed auto switch specifications.

Auto switch type	Part no.	Electrical entry	Features
Solid state	D-H7A1, H7A2, H7B	Grommet (in-line)	—
	D-G59, G5P, K59		Diagnostic indication (2-color indicator)
	D-H7NW, H7PW, H7BW		Water resistant (2-color indicator)
	D-G59W, G5PW, K59W		With timer
	D-G5BA, H7BA		Diagnostic output (2-color indicator)
	D-G5NT		—
Reed	D-G59F	Grommet (in-line)	—
	D-C73, C76, B53		With indicator light
	D-C80		—

* Solid state auto switches are also available with pre-wired connector. Refer to pages 474 and 475 for details.

* Normally closed (N.C. = b contact), solid state auto switches (D-F9G, F9H) are also available. For details, refer to page 443.

How to Mount and Move the Auto Switch

⚠ Caution

1. Tighten the screw under the specified torque when mounting auto switch.
2. Set the auto switch mounting band perpendicularly to cylinder tube.

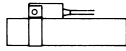

Mounting correctly

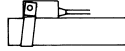

Mounting incorrectly

<Applicable auto switch>

- Solid state D-M9N, M9P, M9B, M9NV, M9PV, M9BV
 D-M9NW, M9PW, M9BW, M9NWV, M9PWV, M9BWV
 D-M9NA, M9PA, M9BA, M9NAV, M9PAV, M9BAV
 Reed..... D-A90, A93, A96, A90V, A93V, A96V

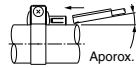

Figure 1. Switch insert angle

How to Mount and Move the Auto Switch

Mounting the Auto Switch

1. Mount the auto switch mounting band around the auto switch setting position on the cylinder tube.
2. Place the switch holder in the opening of the auto switch mounting band (1).
3. Make the concave part of the switch bracket faced downward and set the switch bracket on the switch holder (2).
Set the switch bracket so that both ends of the auto switch mounting band enter the portion between the ribs on both side surfaces of the switch bracket.
For the D-M9□A(V) type auto switch, do not install the switch bracket on the indicator light.
4. Pass the auto switch mounting screw (M3) supplied with the auto switch mounting band and engage it with the M3 female thread of the auto switch mounting band through the through-hole in the switch bracket.
5. Tighten the auto switch mounting screw with the specified tightening torque (0.6 to 0.7 N·m).
6. Insert the auto switch into the auto switch mounting groove of the switch holder (2).
7. After checking the detection position, tighten the set screw (M2.5) supplied with the auto switch to secure the auto switch.

Tightening torque for the set screw (M2.5) supplied with the auto switch (N·m)

Auto switch model	Tightening torque
D-M9□(V)	0.05 to 0.15
D-M9□W(V)	
D-M9□A(V)	
D-A9□(V)	0.1 to 0.2

When tightening the set screw supplied with the auto switch, use a watchmaker's screw driver with a handle diameter of 5 to 6 mm.

Adjustment the Auto Switch Position

- (1) To make the fine adjustment, loosen the set screw (M2.5) supplied with the auto switch and slide the auto switch inside the auto switch mounting groove to adjust the position.
- (2) To move the auto switch setting position largely, loosen the screw (M3) that secures the auto switch mounting band and slide the auto switch together with the switch holder on the cylinder tube to adjust the position.

Note) When removing the screw connection part with the auto switch mounting screw after the auto switch mounting band has been assembled, be careful not to drop the switch bracket, switch holder, auto switch mounting screw, or auto switch mounting band.

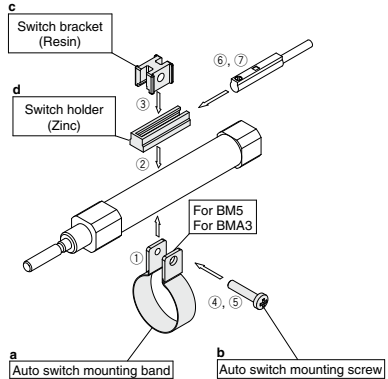

<Switch bracket>

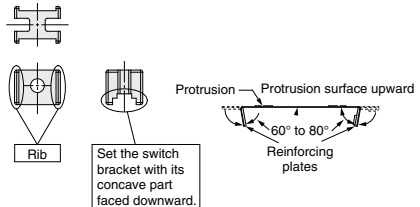

CHK

CHK□

CHN

CHM

CHS□

CH2□

CHA

Related Products

D-□

How to Mount and Move the Auto Switch

⚠ Caution

1. Tighten the screw under the specified torque when mounting auto switch.
2. Set the auto switch mounting band perpendicularly to cylinder tube.

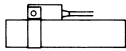

Mounting correctly

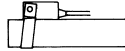

Mounting incorrectly

<Applicable auto switch>

Solid state D-G59, D-G5P, D-K59, D-G5BA
 D-G59W, D-G5PW, D-K59W
 D-G59F, D-G5NT, D-G5NB
 Reed D-B53, D-B54, D-B64, D-B59W

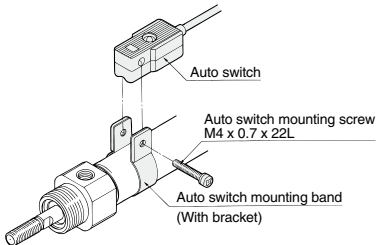

1. Put an auto switch mounting band on the cylinder tube and set it at the auto switch mounting position.
2. Put the mounting section of the auto switch between the auto switch mounting band mounting holes, then adjust the position of mounting holes of switch to those of mounting band.
3. Lightly thread the auto switch mounting screw through the mounting hole into the thread part of band fitting.
4. After reconfirming the detection position, tighten the auto switch mounting screw to secure the auto switch while properly contacting the auto switch bottom part and the cylinder tube. (The tightening torque of M4 screw should be about 1 to 1.2 N·m.)
5. Modification of the detection position should be made in the condition of 3.

<Applicable auto switch>

Solid state D-H7A1, D-H7A2, D-H7B, D-H7BA
 D-H7C, D-H7NF, D-H7NW, D-H7PW,
 D-H7BW
 Reed D-C73, D-C76, D-C80, D-C73C, D-C80C

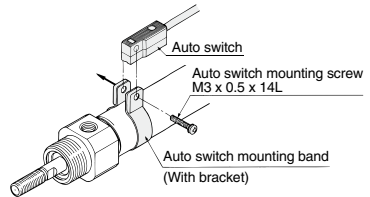

1. Put an auto switch mounting band on the cylinder tube and set it at the auto switch mounting position.
2. Put the mounting section of the auto switch between the auto switch mounting band mounting holes, then adjust the position of mounting holes of switch to those of mounting band.
3. Lightly thread the auto switch mounting screw through the mounting hole into the thread part of the auto switch mounting band fitting.
4. After setting the whole body to the detecting position by sliding, tighten the auto switch mounting screw to secure the auto switch while properly contacting the auto switch bottom part and the cylinder tube. (Tightening torque of M3 screw should be 0.8 to 1 N·m.)
5. Modification of the detection position should be made in the condition of 3.

How to Mount and Move the Auto Switch

⚠ Caution

1. Tighten the screw under the specified torque when mounting auto switch.
2. Set the auto switch mounting band perpendicularly to cylinder tube.

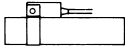

Mounting correctly

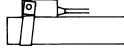

Mounting incorrectly

<Applicable auto switch>

Solid state D-G39, D-K39

Reed D-A33, D-A34, D-A44

How to Mount and Move the Auto Switch

D-A3, D-G3/K3 type

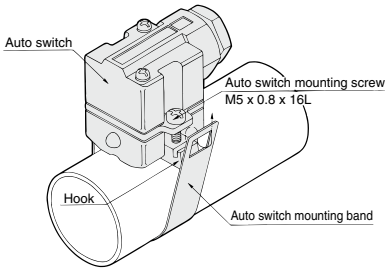

D-A4

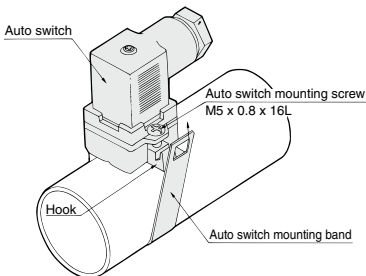

1. Loosen the auto switch mounting screws at both sides to pull down the hook.
2. Put an auto switch mounting band on the cylinder tube and set it at the auto switch mounting position, and then hook the band.
3. Screw lightly the auto switch mounting screw.
4. Set the whole body to the detecting position by sliding, tighten the auto switch mounting screw to secure the auto switch. (The tightening torque should be about 2 to 3 N·m.)
5. Modification of the detecting position should be made in the condition of 3.

CHQ

CHK□

CHN

CHM

CHS□

CH2□

CHA

Related Products

D-□