

Electric Actuators

LEPY/LEPS Series



Miniature Rod Type/Miniature Slide Table Type



Step Motor (Servo/24 VDC)

Compact and lightweight

- Maximum pushing force: **50 N**
- Positioning repeatability: **±0.05 mm**
- Possible to set position, speed and force. (64 points)

Rod Type LEPY Series

Size: 6, 10 ▶Page 374

Weight **240 g**

* LEPY6□-25



Slide Table Type LEPS Series

Size: 6, 10 ▶Page 383

Weight **290 g**

* LEPS6□-25

Linear guide integrated

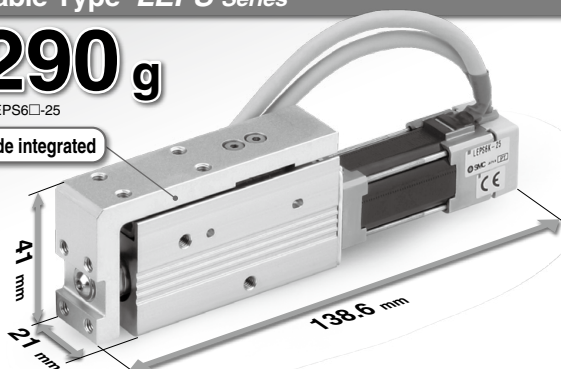

Step Motor (Servo/24 VDC) Controller/Driver

▶Page 547

▶ Step data input type
LECP6 Series

- 64 points positioning
- Input using controller setting kit or teaching box



▶ CC-Link direct input type
LECPMJ Series*

- ▶ EtherCAT®/EtherNet/IP™/PROFINET/DeviceNet™/IO-Link direct input type
JXCE1/91/P1/D1/L1 Series

* Not applicable to CE.



▶ Programless type
LECP1 Series

- 14 points positioning
- Control panel setting



▶ Pulse input type
LECPA Series



Compact and lightweight

Rod Type *LEPY Series*

Weight **240 g**
(LEPY6□-25)

Slide Table Type *LEPS Series*

Weight **290 g**
(LEPS6□-25)

Motor type can be selected to suit the application.
(Size 10 only)

- High pushing force type/basic type
- Compact and lightweight motor type

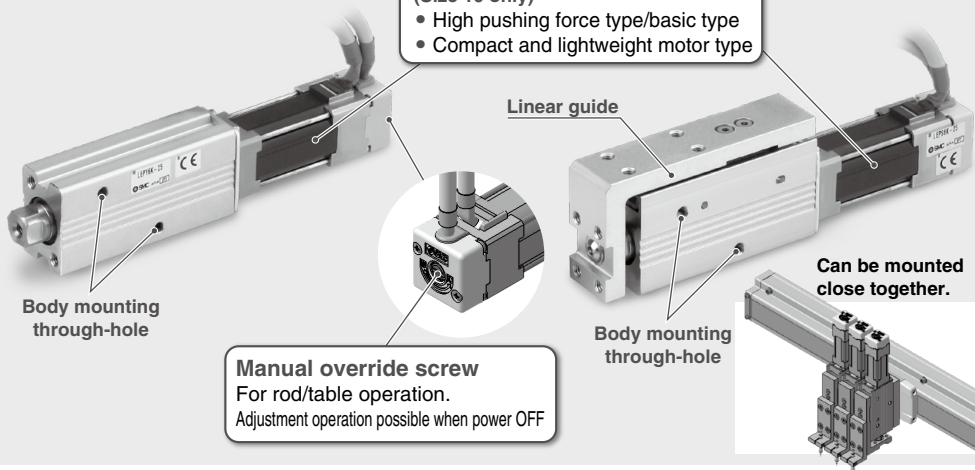

Application Examples

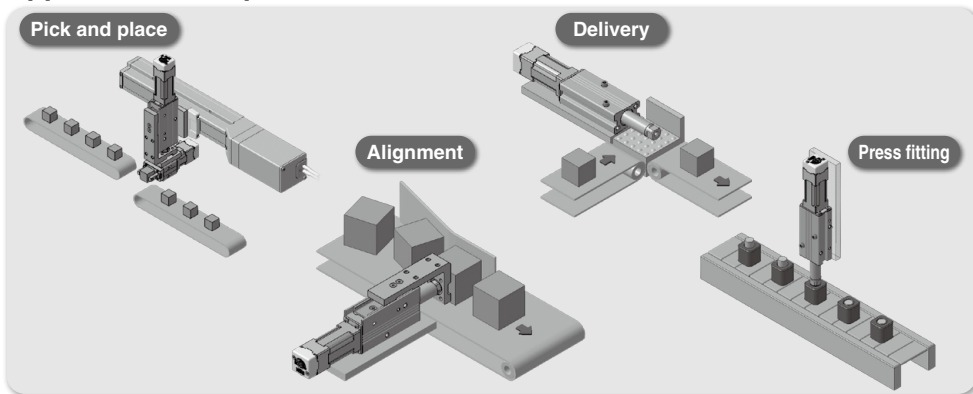

Variations

Type	Size	Screw lead	Pushing force [N]		Max. work load [kg] (Horizontal)		Max. work load [kg] (Vertical)		Max. speed [mm/s] (Horizontal)		Stroke [mm]	Page
			Basic	Compact	Basic	Compact	Basic	Compact	Basic	Compact		
Rod type <i>LEPY Series</i>	6	4	14 to 20	—	2.0	—	0.5	—	150	—	25 50 75	Page 374
		8	7 to 10	—	1.0	—	0.25	—	300	—		
	10	5	25 to 50	24 to 40	6.0	4.0	1.5	1.5	200	200		
		10	12.5 to 25	12 to 20	3.0	2.0	1.0	1.0	350	350		
Slide table type <i>LEPS Series</i>	6	4	14 to 20	—	1.0	—	0.5	—	150	—	25 50	Page 383
		8	7 to 10	—	0.75	—	0.25	—	300	—		
	10	5	25 to 50	24 to 40	2.0	2.0	1.5	1.5	200	200		
		10	12.5 to 25	12 to 20	1.5	1.5	1.0	1.0	350	350		

Mounting Variations

Mounting from various directions

Side mounting (Body mounting through-hole)

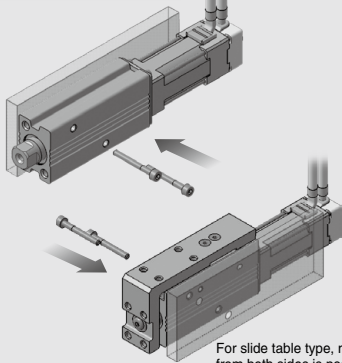

For slide table type, mounting from both sides is possible.

Side mounting (Body tapped)

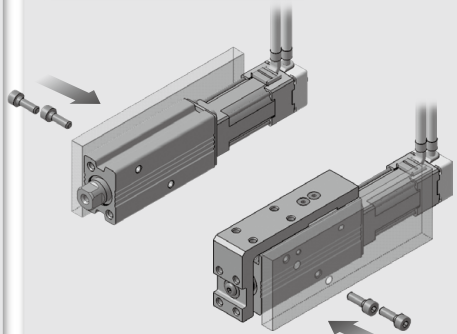

For slide table type, body tapped from both sides.

Bottom mounting (Body tapped)

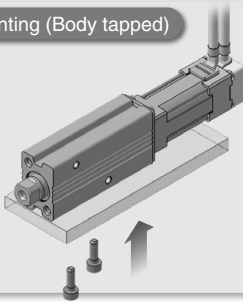

Axial mounting * Rod type only (Body tapped)

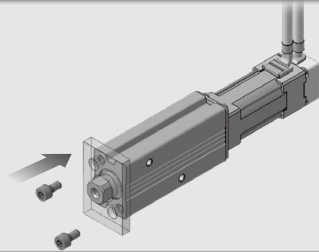

Motor Cable Entry Direction

Can be selected from 4 directions.

Top entry (Basic model)

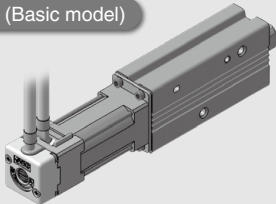

Entry on the right side (When selecting "R")

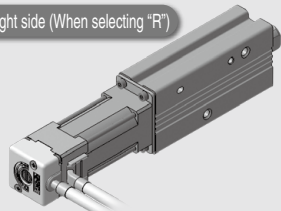

Bottom entry (When selecting "U")

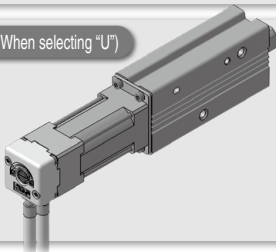

Entry on the left side (When selecting "L")

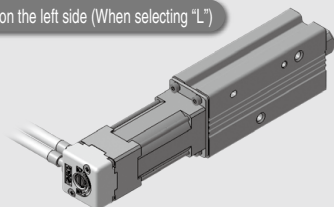

Step Motor (Servo/24 VDC)

Electric Actuator/Miniature Rod Type *LEPY Series*



Model Selection	Page 374
How to Order	Pages 378, 379-1
Specifications	Page 380
Construction	Page 380
Dimensions	Page 381

Step Motor (Servo/24 VDC)

Electric Actuator/Miniature Slide Table Type *LEPS Series*



Model Selection	Page 383
How to Order	Pages 390, 391-1
Specifications	Page 392
Construction	Page 392
Dimensions	Page 393
Specific Product Precautions	Page 395

Step Motor (Servo/24 VDC) Controller



Step Data Input Type/ <i>LECP6 Series</i>	Page 560
Controller Setting Kit/ <i>LEC-W2</i>	Page 569
Teaching Box/ <i>LEC-T11</i>	Page 570
CC-Link Direct Input Type/ <i>LECPMJ Series</i>	Page 600
Controller Setting Kit/ <i>LEC-W2</i>	Page 603-2
Teaching Box/ <i>LEC-T1</i>	Page 603-3
EtherCAT®/EtherNet/IP™/PROFINET/DeviceNet™/IO-Link Direct Input Type/ <i>JXCE1/91/P1/D1/L1 Series</i>	Page 603-5
Controller Setting Kit/ <i>LEC-W2</i>	Page 603-10
Teaching Box/ <i>LEC-T1</i>	Page 605
Gateway Unit/ <i>LEC-G Series</i>	Page 572
Programless Controller/ <i>LECP1 Series</i>	Page 576
Step Motor Driver/ <i>LECPA Series</i>	Page 590
Controller Setting Kit/ <i>LEC-W2</i>	Page 597
Teaching Box/ <i>LEC-T11</i>	Page 598

4-Axis Step Motor (Servo/24 VDC) Controller



Parallel I/O Type/ <i>JXC73/83 Series</i>	Page 606-1
EtherNet/IP™ Type/ <i>JXC93 Series</i>	Page 606-1

Miniature Rod Type *LEPY Series*

Step Motor (Servo/24 VDC)



Miniature Slide Table Type *LEPS Series*

Step Motor (Servo/24 VDC)



Model Selection

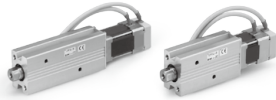

LEPY Series ▶ Pages 378, 379-1

Selection Procedure

Positioning Control Selection Procedure

Step 1 Check the work load–speed.
(Vertical transfer)

Step 2 Check the cycle time.

Selection Example

Operating conditions

- Workpiece mass: 0.2 [kg]
- Speed: 200 [mm/s]
- Acceleration/Deceleration: 3000 [mm/s²]
- Stroke: 40 [mm]
- Workpiece mounting condition: Vertical upward downward transfer

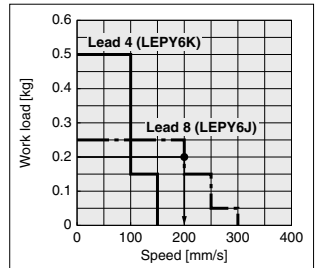
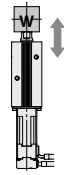
<Speed-Work load graph>
(LEPY6/Step motor)

Step 1 Check the work load–speed. <Speed-Work load graph>

Select the target model based on the workpiece mass and speed with reference to the <Speed-Work load graph>.

Selection example) The **LEPY6J** is temporarily selected based on the graph shown on the right side.

* It is necessary to mount a guide outside the actuator when used for horizontal transfer. When selecting the target model, refer to page 380 for the horizontal work load in the specifications, and page 380 for the precautions.

Step 2 Check the cycle time.

Calculate the cycle time using the following calculation method.

- Cycle time T can be found from the following equation.

$$T = T1 + T2 + T3 + T4 \text{ [s]}$$

- T1: Acceleration time and T3: Deceleration time can be obtained by the following equation.

$$T1 = V/a1 \text{ [s]} \quad T3 = V/a2 \text{ [s]}$$

- T2: Constant speed time can be found from the following equation.

$$T2 = \frac{L - 0.5 \cdot V \cdot (T1 + T3)}{V} \text{ [s]}$$

- T4: Settling time varies depending on the conditions such as motor types, load and in position of the step data. Therefore, calculate the settling time with reference to the following value.

$$T4 = 0.2 \text{ [s]}$$

Calculation example)

T1 to T4 can be calculated as follows.

$$T1 = V/a1 = 200/3000 = 0.067 \text{ [s]}, T3 = V/a2 = 200/3000 = 0.067 \text{ [s]}$$

$$T2 = \frac{L - 0.5 \cdot V \cdot (T1 + T3)}{V} = \frac{40 - 0.5 \cdot 200 \cdot (0.067 + 0.067)}{200} = 0.133 \text{ [s]}$$

$$T4 = 0.2 \text{ [s]}$$

Therefore, the cycle time can be obtained as follows.

$$T = T1 + T2 + T3 + T4 = 0.067 + 0.133 + 0.067 + 0.2 = 0.467 \text{ [s]}$$

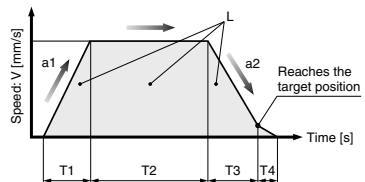

L : Stroke [mm] ... (Operating condition)
 V : Speed [mm/s] ... (Operating condition)
 a1: Acceleration [mm/s²] ... (Operating condition)
 a2: Deceleration [mm/s²] ... (Operating condition)

T1: Acceleration time [s] ... Time until reaching the set speed

T2: Constant speed time [s] ... Time while the actuator is operating at a constant speed

T3: Deceleration time [s] ... Time from the beginning of the constant speed operation to stop

T4: Settling time [s] ... Time until positioning is completed

Based on the above calculation result, the **LEPY6J-50** is selected.

Selection Procedure

Pushing Control Selection Procedure



* The duty ratio is a ratio at the time that can keep being pushed.

Selection Example

Operating conditions

- Mounting condition: Horizontal (pushing)
- Jig weight: 0.05 [kg]
- Pushing force: 30 [N]
- Duty ratio: 70 [%]
- Speed: 150 [mm/s]
- Stroke: 40 [mm]

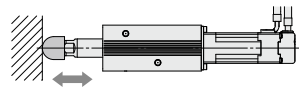

Step 1 Check the duty ratio.

<Conversion table of pushing force–duty ratio>

Select the [Pushing force] from the duty ratio with reference to the <Conversion table of pushing force–duty ratio>.

Selection example)

Based on the table below,

- Duty ratio: 70 [%]

Therefore, the set value of pushing force will be 80 [%].

<Conversion table of pushing force–duty ratio> (LEPY10L)

Set value of pushing force [%]	Duty ratio [%]	Continuous pushing time [minute]
70 or less	100	—
80	70	10
100	50	5

* [Set value of pushing force] is one of the step data input to the controller.

* [Continuous pushing time] is the time that the actuator can continuously keep pushing.

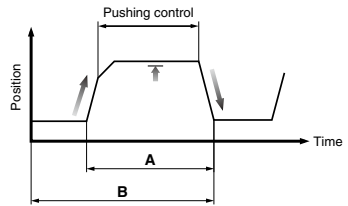

$$\text{Duty ratio} = A/B \times 100 [\%]$$

Step 2 Check the pushing force. <Set value of pushing force–Force graph>

Select the target model based on the set value of pushing force and force with reference to the <Set value of pushing force–Force graph>.

Selection example)

Based on the graph shown on the right side,

- Set value of pushing force: 75 [%]
- Pushing force: 30 [N]

Therefore, the LEPY10LK is temporarily selected.

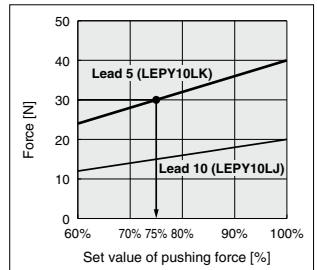

<Set value of pushing force–Force graph> (LEPY10L)

Step 3 Check the lateral load on the rod end.

<Allowable lateral load on the rod end>

Confirm the allowable lateral load on the rod end of the actuator: LEPY10L, which has been selected temporarily with reference to the <Allowable lateral load on the rod end>.

Selection example)

Based on the table below,

- Jig weight: 0.05 [kg] \approx 0.5 [N]

Therefore, the lateral load on the rod end is in the allowable range.

<Allowable lateral load on the rod end>

Model	Allowable lateral load on the rod end [N]
LEPY6 (Basic)	0.50
LEPY10 (Basic)	1.0
LEPY10L (Compact)	1.0

Based on the above calculation result, the LEPY10LK-50 is selected.

LEPY Series

Step Motor (Servo/24 VDC)

Speed-Work Load Graph (Guide)

* The following graph shows the values when moving force is 150%.

LEPY6 (Basic)

Horizontal

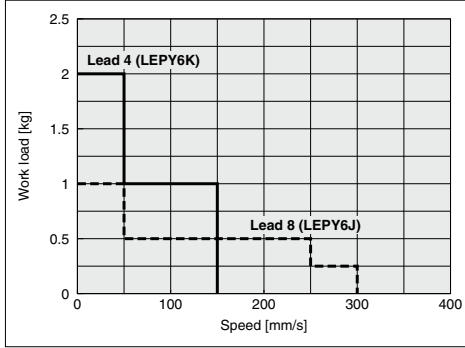

Vertical

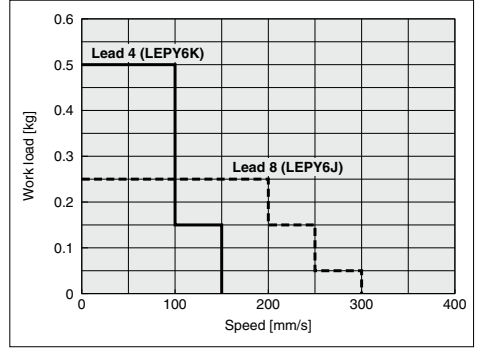

LEPY10L (Motor size: Compact)

Horizontal

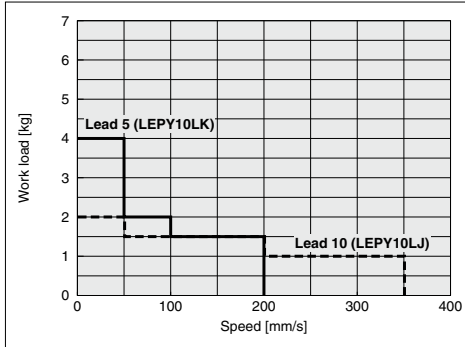

Vertical

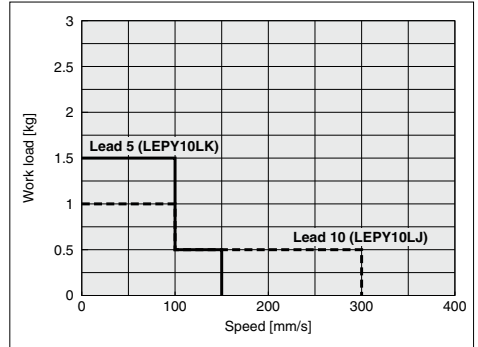

LEPY10 (Motor size: Basic)

Horizontal

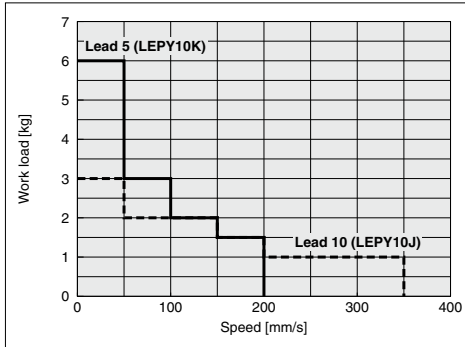

Vertical

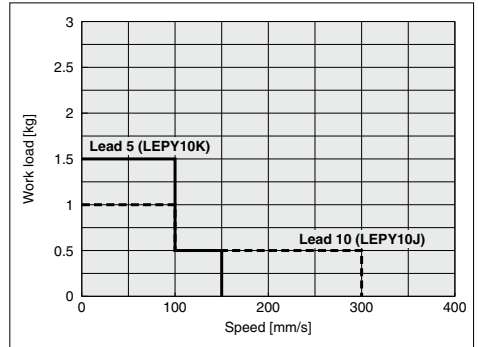

Note) The maximum value of the work load for the positioning operation. An external guide is necessary to support the load.
The actual work load and transfer speed change according to the condition of the external guide.

Set Value of Pushing Force–Force Graph (Guide)

LEPY6 (Basic)

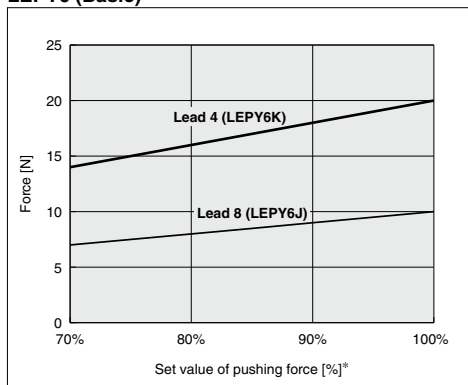

Set value of pushing force [%]	Duty ratio [%]	Continuous pushing time [minute]
70	100	—
80	70	10
100	50	5

LEPY10 (Basic)

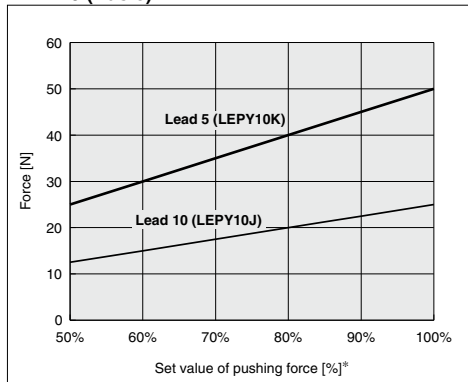

Set value of pushing force [%]	Duty ratio [%]	Continuous pushing time [minute]
60 or less	100	—
70	30	3
100	15	1

LEPY10L (Compact)

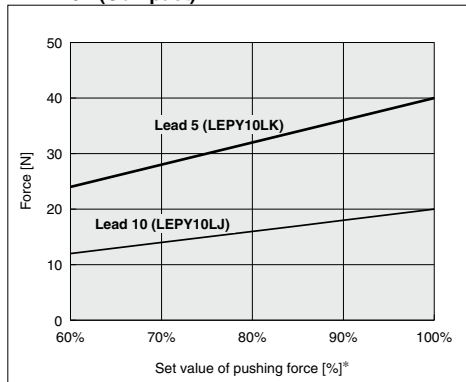

Set value of pushing force [%]	Duty ratio [%]	Continuous pushing time [minute]
70 or less	100	—
80	70	10
100	50	5

* Set values for the controller.

Allowable Lateral Load on the Rod End

Model	Allowable lateral load on the rod end [N]
LEPY6 (Basic)	0.50
LEPY10 (Basic)	1.0
LEPY10L (Compact)	1.0



Electric Actuator Miniature Rod Type

LEPY Series LEPY6, 10

Applicable to the
LEC□ series



Refer to page 379-1 for the communication protocols EtherCAT®, EtherNet/IP™, PROFINET, DeviceNet™, and IO-Link.

How to Order

LEPY **10** **□** **K** - **50** **□** - **R1** **6N** **1** **□**

① ② ③ ④ ⑤ ⑥ ⑦ ⑧ ⑨

① Size

6
10

② Motor size

Symbol	Motor size	Applicable size
Nil	Basic	6, 10
L	Compact	10



③ Lead screw type [mm]

Symbol	Screw lead	
	LEPY6	LEPY10
K	4	5
J	8	10

④ Stroke [mm]

Symbol	Stroke
25	25
50	50
75	75

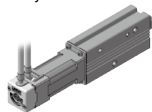
⑤ Motor cable mounting direction

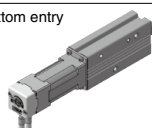
Nil	Top entry 	L	Entry on the left side 
	Bottom entry 		R

⚠ Caution

[CE-compliant products]

① EMC compliance was tested by combining the electric actuator LEP series and the controller LEC series.

The EMC depends on the configuration of the customer's control panel and the relationship with other electrical equipment and wiring. Therefore, conformity to the EMC directive cannot be certified for SMC components incorporated into the customer's equipment under actual operating conditions. As a result, it is necessary for the customer to verify conformity to the EMC directive for the machinery and equipment as a whole.

② CC-Link direct input type (LECPMJ) is not CE-compliant.

[UL-compliant products]

When conformity to UL is required, the electric actuator and controller/driver should be used with a UL1310 Class 2 power supply.

The actuator and controller/driver are sold as a package.

Confirm that the combination of the controller/driver and the actuator is correct.

<Check the following before use.>

- ① Check the actuator label for model number. This matches the controller/driver.
- ② Check Parallel I/O configuration matches (NPN or PNP).

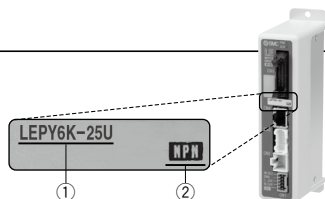

* Refer to the operation manual for using the products. Please download it via our website, <http://www.smcworld.com>



6 Actuator cable type/length

Nil	Without cable
S1	Standard cable 1.5 m
S3	Standard cable 3 m
S5	Standard cable 5 m
R1	Robotic cable 1.5 m
R3	Robotic cable 3 m
R5	Robotic cable 5 m
R8	Robotic cable 8 m ^{*1}
RA	Robotic cable 10 m ^{*1}
RB	Robotic cable 15 m ^{*1}
RC	Robotic cable 20 m ^{*1}

*1 Produced upon receipt of order (Robotic cable only)

*2 The standard cable should only be used on fixed parts.

For use on moving parts, select the robotic cable.

9 Controller/Driver mounting

Nil	Screw mounting
D	DIN rail mounting*

* DIN rail is not included. Order it separately.

7 Controller/Driver type^{*1}

Nil	Without controller/driver	
6N	LECP6	NPN
6P	(Step data input type)	PNP
1N	LECP1	NPN
1P	(Programless type)	PNP
MJ	LECPMJ ^{*2} (CC-Link direct input type)	—
AN	LECPA ^{*3}	NPN
AP	(Pulse input type)	PNP

*1 For details about controller/driver and compatible motor, refer to the compatible controller/driver below.

*2 Not applicable to CE.

*3 When pulse signals are open collector, order the current limiting resistor (LEC-PA-R-□) on page 596 separately.

8 I/O cable length [m]^{*1}, Communication plug





Nil	Without cable (Without communication plug connector) ^{*3}
1	1.5
3	3 ^{*2}
5	5 ^{*2}
S	Straight type communication plug connector ^{*3}
T	T-branch type communication plug connector ^{*3}

*1 When "Without controller/driver" is selected for controller/driver types, I/O cable cannot be selected. Refer to page 568 (For LECP6), page 582 (For LECP1) or page 596 (For LECPA) if I/O cable is required.

*2 When "Pulse input type" is selected for controller/driver types, pulse input usable only with differential. Only 1.5 m cables usable with open collector.

*3 For the LECPMJ, only "Nil", "S" and "T" are selectable since I/O cable is not included.

Compatible Controller/Driver

Type	Step data input type	CC-Link direct input type	Programless type	Pulse input type
				
Series	LECP6	LECPMJ	LECP1	LECPA
Features	Value (Step data) input Standard controller	CC-Link direct input	Capable of setting up operation (step data) without using a PC or teaching box	Operation by pulse signals
Compatible motor	Step motor (Servo/24 VDC)			
Maximum number of step data	64 points		14 points	—
Power supply voltage	24 VDC			
Reference page	Page 560	Page 600	Page 576	Page 590

Electric Actuator Miniature Rod Type

LEPY Series LEPY6, 10

Applicable to the
JXC□ series



How to Order

Refer to page 378 for the communication protocol CC-Link.

LEPY **10** **□** **K** - **50** **□** - **R1** **CD17T**

①
②
③
④
⑤
⑥
⑦

① Size

6
10

② Motor size

Symbol	Motor size	Applicable size
Nil	Basic	6, 10
L	Compact	10

③ Lead screw type [mm]

Symbol	Screw lead	
	LEPY6	LEPY10
K	4	5
J	8	10

④ Stroke [mm]

Symbol	Stroke
25	25
50	50
75	75

⑤ Motor cable mounting direction

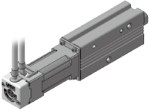
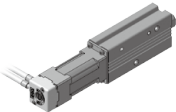
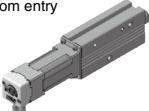
Nil	Top entry 	L	Entry on the left side 
	Bottom entry 		R

⚠ Caution

[CE-compliant products]

EMC compliance was tested by combining the electric actuator LE series and the JXCE1/91/P1/D1/L1 series.

The EMC depends on the configuration of the customer's control panel and the relationship with other electrical equipment and wiring. Therefore, conformity to the EMC directive cannot be certified for SMC components incorporated into the customer's equipment under actual operating conditions. As a result, it is necessary for the customer to verify conformity to the EMC directive for the machinery and equipment as a whole.



6 Actuator cable type/length

Nil	Without cable
S1	Standard cable 1.5 m
S3	Standard cable 3 m
S5	Standard cable 5 m
R1	Robotic cable 1.5 m
R3	Robotic cable 3 m
R5	Robotic cable 5 m
R8	Robotic cable 8 m ^{*1}
RA	Robotic cable 10 m ^{*1}
RB	Robotic cable 15 m ^{*1}
RC	Robotic cable 20 m ^{*1}

*1 Produced upon receipt of order (Robotic cable only)

*2 The standard cable should only be used on fixed parts.
For use on moving parts, select the robotic cable.

7 Controller

Nil	Without controller
C□1□□	With controller

C D 1 7 T

Communication protocol

E	EtherCAT®
9	EtherNet/IP™
P	PROFINET
D	DeviceNet™
L	IO-Link

For single axis

Communication plug connector for DeviceNet™

Nil	Without plug connector
S	Straight type
T	T-branch type





* Select "Nil" for anything other than DeviceNet™.

Mounting

7	Screw mounting
8*	DIN rail mounting

* The DIN rail is not included. It must be ordered separately.
(Refer to page 603-8.)

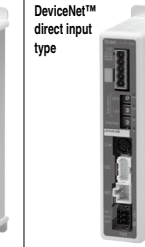
Compatible Controller

Type					
Series	JXCE1	JXC91	JXCP1	JXCD1	JXCL1
Features	EtherCAT® direct input	EtherNet/IP™ direct input	PROFINET direct input	DeviceNet™ direct input	IO-Link direct input
Compatible motor	Step motor (Servo/24 VDC)				
Maximum number of step data	64 points				
Power supply voltage	24 VDC				
Reference page	Page 603-5				

LEPY Series

Step Motor (Servo/24 VDC)



Weight

Model	LEPY6			
Stroke [mm]	25	50	75	
Product weight [kg]	Basic	0.24	0.29	0.34

Model	LEPY10			
Stroke [mm]	25	50	75	
Product weight [kg]	Basic	0.47	0.55	0.65
	Compact	0.41	0.49	0.59

Specifications

Model		LEPY6		LEPY10	
Stroke [mm]				25, 50, 75	
Screw lead [mm]		4		8	
Pushing force [N]		Basic		14 to 20	
		Compact		7 to 10	
		Basic		25 to 50	
		Compact		12.5 to 25	
Work load [kg]		Horizontal		Basic	
		Compact		2.0	
		Basic		1.0	
		Compact		6.0	
		Basic		4.0	
		Compact		2.0	
		Vertical		Basic	
		Compact		0.5	
		Basic		0.25	
		Compact		1.5	
		Basic		1.0	
		Compact		1.5	
Speed [mm/s]		Horizontal		Basic	
		Compact		10 to 150	
		Basic		20 to 300	
		Compact		10 to 200	
		Basic		20 to 350	
		Vertical		Basic	
		Compact		10 to 150	
		Basic		20 to 300	
		Compact		10 to 150	
		Basic		20 to 300	
		Compact		20 to 300	
Pushing speed [mm/s]		10		20	
Acceleration/Deceleration [mm/s ²]		3000			
Backlash [mm]		0.2 or less			
Positioning repeatability [mm]		±0.05			
Lost motion [mm]		0.2 or less			
Impact/Vibration resistance [m/s ²]		50/20			
Actuation type		Slide screw			
Guide type		Sliding bushing			
Max. operating frequency [c.p.m]		60			
Operating temperature range [°C]		5 to 40			
Operating humidity range [%RH]		90 or less (No condensation)			
Motor size		□20		□28	
Motor type		Step motor (Servo/24 VDC)			
Encoder		Incremental A/B phase (800 pulse/rotation)			
Rated voltage [V]		24 VDC ±10%			
Power consumption [W]		Basic		12	
		Compact		28	
Standby power consumption when operating [W]		Basic		11	
		Compact		22	
Max. instantaneous power consumption [W]		Basic		16	
		Compact		55	
		Compact		45	

Note 1) Pushing force accuracy is LEPY6: ±30% (F.S.), LEPY10: ±25% (F.S.).

Refer to pages 396 and 397 for the detailed setting range and precautions.

The pushing force and the duty ratio change according to the set value. Check "Set Value of Pushing Force-Force Graph (Guide)" on page 377 and [14] on page 397.

Note 2) The maximum value of the work load for the positioning operation. An external guide is necessary to support the load.

The actual work load and transfer speed change according to the condition of the external guide.

Note 3) Speed changes according to the work load. Check "Speed-Work Load Graph (Guide)" on page 376.

Note 4) When the stroke is 25 mm, the maximum speed will be 250 mm/sec.

Note 5) Set to the pushing force when pushing.

Note 6) The speed and force may change depending on the cable length, load and mounting conditions. Furthermore, if the cable length exceeds 5 m, then it will decrease by up to 10% for each 5 m. (At 15 m: Reduced by up to 20%)

Note 7) A reference value for correcting an error in reciprocal operation.

Note 8) Impact resistance: No malfunction occurred when the actuator was tested with a drop tester in both an axial direction and a perpendicular direction to the lead screw. (Test was performed with the actuator in the initial state.)

Vibration resistance: No malfunction occurred in a test ranging between 45 to 2000 Hz. Test was performed in both an axial direction and a perpendicular direction to the lead screw. (Test was performed with the actuator in the initial state.)

Note 9) The power consumption (including the controller) is for when the actuator is operating.

Note 10) The standby power consumption when operating (including the controller) is for when the actuator is stopped in the set position during operation. Except during the pushing operation.

Note 11) The maximum instantaneous power consumption (including the controller) is for when the actuator is operating. This value can be used for the selection of the power supply.

Construction

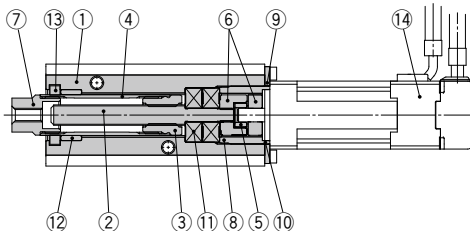

Component Parts

No.	Description	Material	Note
1	Body	Aluminum alloy	Anodized
2	Screw shaft	Stainless steel	Heat treatment + Specially treated
3	Screw nut	Stainless steel	Heat treatment + Specially treated
4	Rod	Stainless steel	
5	Spider	NBR	
6	Hub	Aluminum alloy	
7	Socket	Free cutting carbon steel	Nickel plating
8	Bearing stopper	Size 6: Aluminum alloy Size 10: Carbon steel	
9	Motor plate	Aluminum alloy	Anodized
10	Guide ring	Aluminum alloy	Size 10 only
11	Bearing	—	
12	Bushing	Oil impregnated sintered copper alloy	
13	Soft wiper	—	
14	Step motor (Servo/24 VDC)	—	

Dimensions

LEPY6

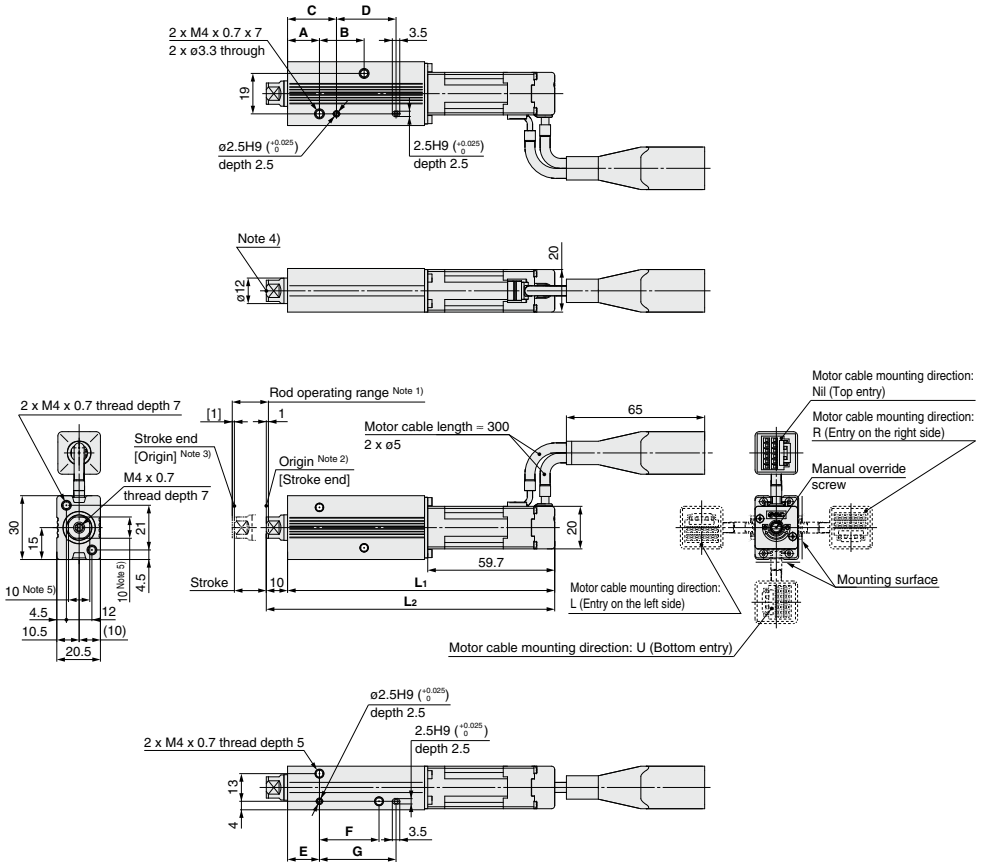

Note 1) Range within which the rod can move when it returns to origin.

Make sure a workpiece mounted on the rod does not interfere with the workpieces and facilities around the rod.

Note 2) Position after return to origin.

Note 3) [] for when the direction of return to origin has changed.

Note 4) Do not apply rotational torque to the rod end.

Note 5) The direction of rod end width across flats (□10) differs depending on the products.

Dimensions

Model	L ₁	L ₂	A	B	C	D	E	F	G
LEPY6□-25□	125.6	135.6	15	21	23	28	15	28	36
LEPY6□-50□	156.6	166.6	22	45	30	52	22	52	60
LEPY6□-75□	188.6	198.6	29	70	37	77	29	77	85

LEPY Series

Step Motor (Servo/24 VDC)

Dimensions

LEPY10

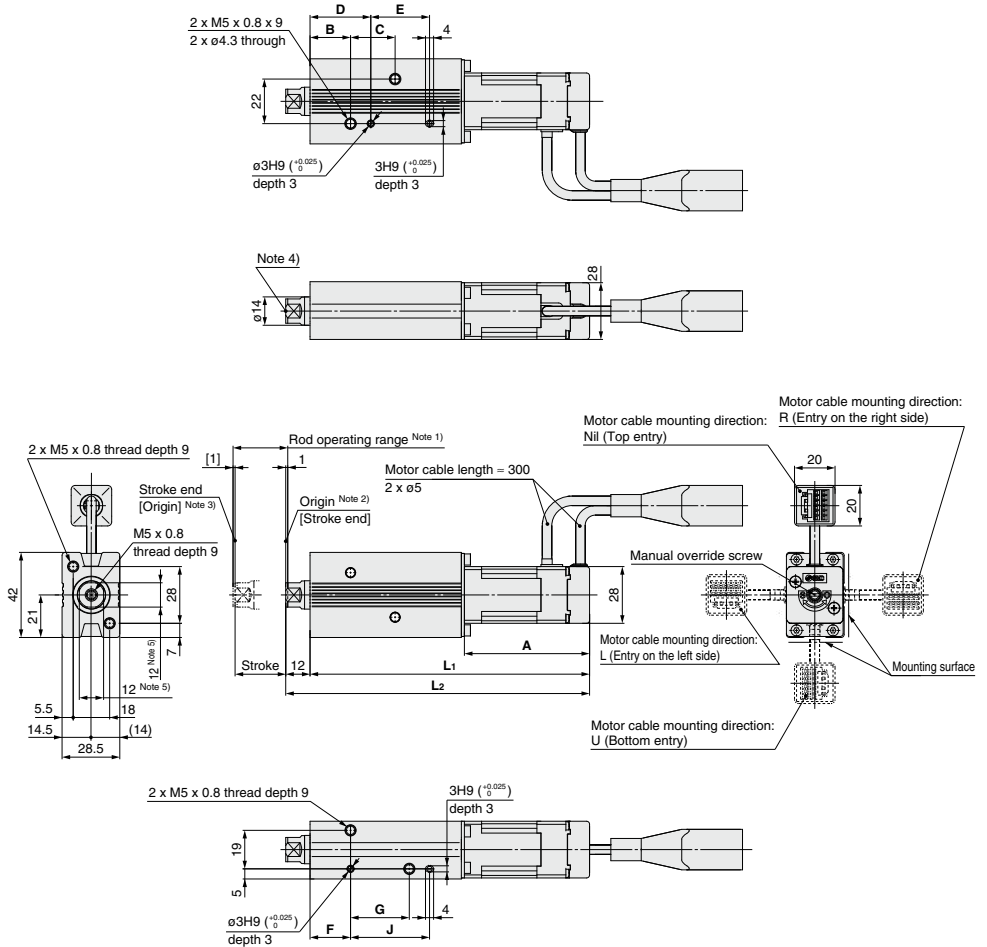

Note 1) Range within which the rod can move when it returns to origin.

Make sure a workpiece mounted on the rod does not interfere with the workpieces and facilities around the rod.

Note 2) Position after return to origin.

Note 3) [] for when the direction of return to origin has changed.

Note 4) Do not apply rotational torque to the rod end.

Note 5) The direction of rod end width across flats (□12) differs depending on the products.

Dimensions

Model	L ₁	L ₂	A	B	C	D	E	F	G	J
LEPY10□-25□	138	150	61.8	20	22	30	29	20	29	39
LEPY10□-50□	163	175		24	43	34	50	24	50	60
LEPY10□-75□	198	210		30	72	40	79	30	79	89
LEPY10□-25□	124	136	47.8	20	22	30	29	20	29	39
LEPY10□-50□	149	161		24	43	34	50	24	50	60
LEPY10□-75□	184	196		30	72	40	79	30	79	89

Model Selection



LEPS Series ▶ Pages 390, 391-1

Selection Procedure

Positioning Control Selection Procedure



Selection Example

Operating conditions

- Workpiece mass: 0.25 [kg]
- Speed: 200 [mm/s]
- Acceleration/Deceleration: 3000 [mm/s²]
- Stroke: 20 [mm]
- Workpiece mounting condition: Horizontal transfer

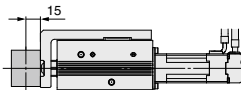

LEPS6 (Basic)

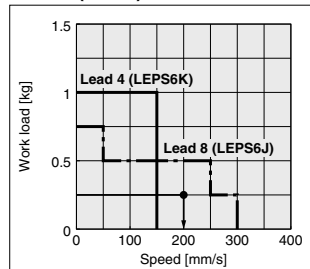

Step 1 Check the work load-speed. <Speed-Work load graph>

Select the target model based on the workpiece mass and speed with reference to the <Speed-Work load graph>.

Selection example) The **LEPS6J** is temporarily selected based on the graph shown on the right side.

Step 2 Check the cycle time.

Calculate the cycle time using the following calculation method.

- Cycle time T can be found from the following equation.

$$T = T1 + T2 + T3 + T4 \text{ [s]}$$

- T1: Acceleration time and T3: Deceleration time can be obtained by the following equation.

$$T1 = V/a1 \text{ [s]}$$

$$T3 = V/a2 \text{ [s]}$$

- T2: Constant speed time can be found from the following equation.

$$T2 = \frac{L - 0.5 \cdot V \cdot (T1 + T3)}{V} \text{ [s]}$$

- T4: Settling time varies depending on the conditions such as motor types, load and in position of the step data. Therefore, calculate the settling time with reference to the following value.

$$T4 = 0.2 \text{ [s]}$$

Calculation example)

T1 to T4 can be calculated as follows.

$$T1 = V/a1 = 200/3000 = 0.067 \text{ [s]}, T3 = V/a2 = 200/3000 = 0.067 \text{ [s]}$$

$$T2 = \frac{L - 0.5 \cdot V \cdot (T1 + T3)}{V} = \frac{20 - 0.5 \cdot 200 \cdot (0.067 + 0.067)}{200} = 0.033 \text{ [s]}$$

$$T4 = 0.2 \text{ [s]}$$

Therefore, the cycle time can be obtained as follows.

$$T = T1 + T2 + T3 + T4 = 0.067 + 0.033 + 0.067 + 0.2 = \mathbf{0.367 \text{ [s]}}$$

Step 3 Check the guide allowable moment.

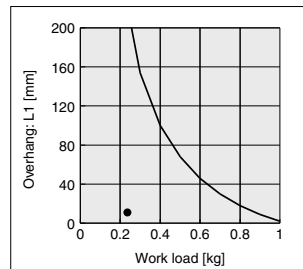
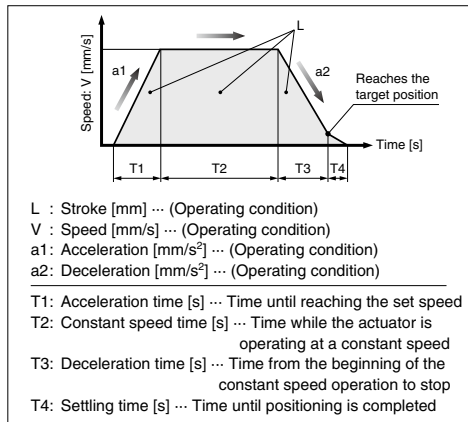

Guide allowable moment

Based on the above calculation result, the **LEPS6J-25** is selected.

Selection Procedure

Pushing Control Selection Procedure



* The duty ratio is a ratio at the time that can keep being pushed.

Selection Example

Operating conditions

- Mounting condition: Horizontal (pushing)
- Duty ratio: 70 [%]
- Jig weight: 0.4 [kg]
- Speed: 150 [mm/s]
- Pushing force: 30 [N]
- Stroke: 40 [mm]

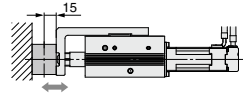

Step 1 Check the duty ratio.

<Conversion table of pushing force–duty ratio>

Select the [Pushing force] from the duty ratio with reference to the <Conversion table of pushing force–duty ratio>.

Selection example)

Based on the table below,

- Duty ratio: 70 [%]

Therefore, the set value of pushing force will be 80 [%].

<Conversion table of pushing force–duty ratio> (LEPS10L)

Set value of pushing force [%]	Duty ratio [%]	Continuous pushing time [minute]
70 or less	100	—
80	70	10
100	50	5

* [Set value of pushing force] is one of the step data input to the controller.

* [Continuous pushing time] is the time that the actuator can continuously keep pushing.

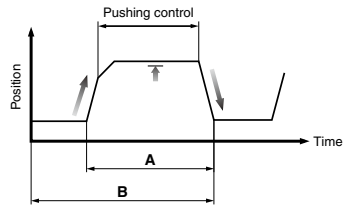

$$\text{Duty ratio} = A/B \times 100 [\%]$$

Step 2 Check the pushing force. <Set value of pushing force–Force graph>

Select the target model based on the set value of pushing force and force with reference to the <Set value of pushing force–Force graph>.

Selection example)

Based on the graph shown on the right side,

- Set value of pushing force: 75 [%]
- Pushing force: 30 [N]

Therefore, the LEPS10LK is temporarily selected.

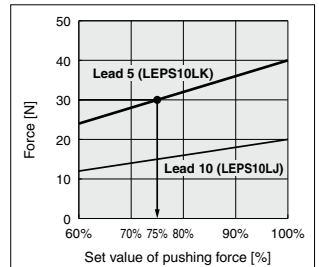

<Set value of pushing force–Force graph>
(LEPS10L)

Step 3 Check the guide allowable moment.

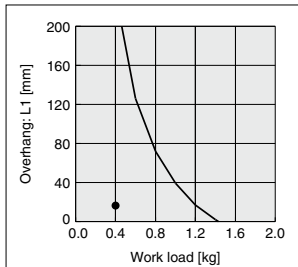

Based on the above calculation result, the LEPS10LK-50 is selected.

Speed–Work Load Graph (Guide)

* The following graph shows the values when moving force is 150%.

LEPS6 (Basic)

Horizontal

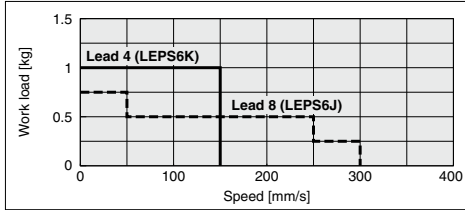

Vertical

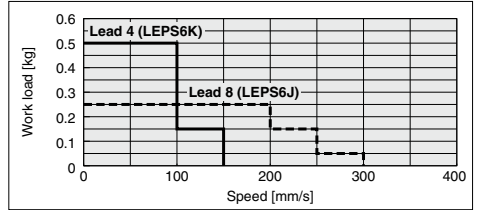

LEPS10(L) (Motor size: Basic/Compact)

Horizontal

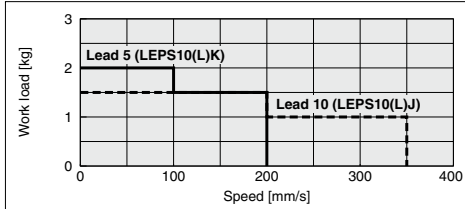

Vertical

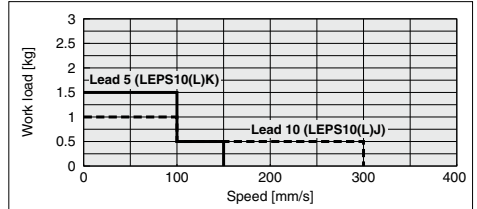

Set Value of Pushing Force–Force Graph (Guide)

LEPS6 (Basic)

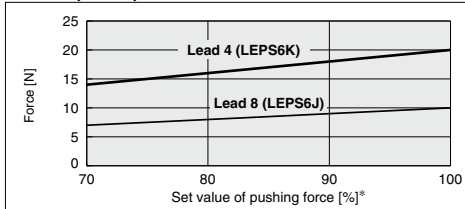

Set value of pushing force [%]	Duty ratio [%]	Continuous pushing time [minute]
70	100	—
80	70	10
100	50	5

* Set values for the controller.

LEPS10 (Basic)

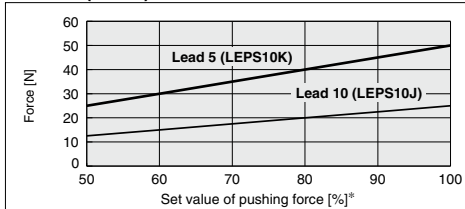

Set value of pushing force [%]	Duty ratio [%]	Continuous pushing time [minute]
60 or less	100	—
70	30	3
100	15	1

LEPS10L (Compact)

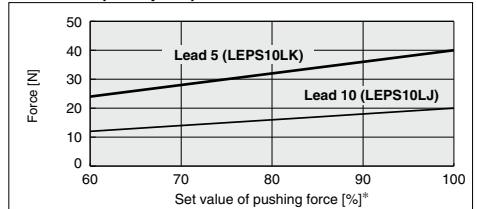



Set value of pushing force [%]	Duty ratio [%]	Continuous pushing time [minute]
70 or less	100	—
80	70	10
100	50	5

Dynamic Allowable Moment

* This graph shows the amount of allowable overhang (guide unit) when the center of gravity of the workpiece overhangs in one direction. When selecting the overhang, refer to the Electric Actuator Selection Software for confirmation, <http://www.smcworld.com>

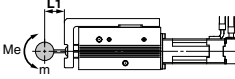
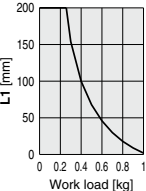
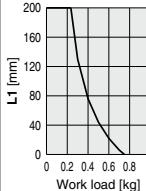
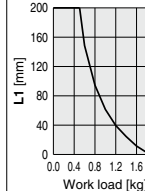
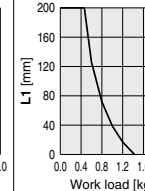
Acceleration/Deceleration — 3000 mm/s²

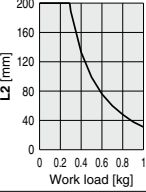
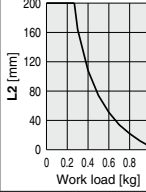
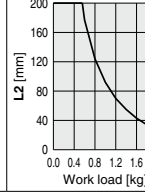
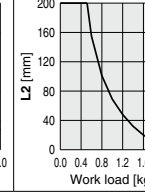
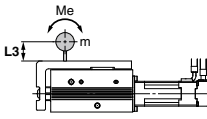
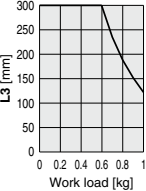
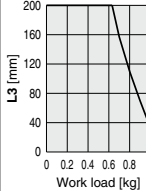
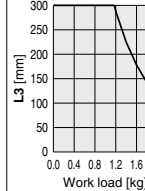
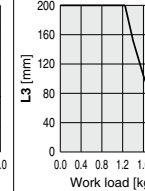
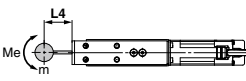
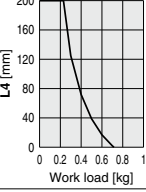
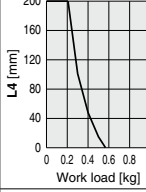
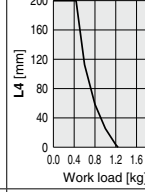
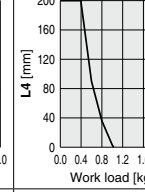
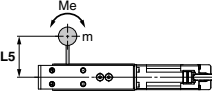
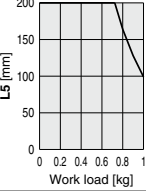
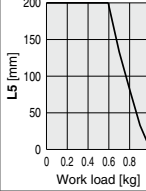
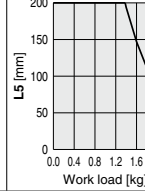
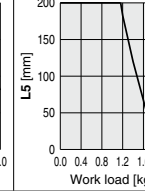
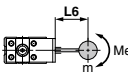
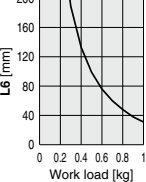
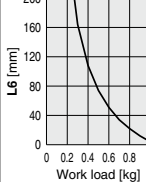
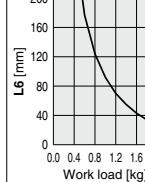
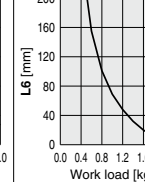
Orientation	Load overhanging direction m : Work load [kg] Me: Dynamic allowable moment [N·m] L : Overhang to the work load center of gravity [mm]	Model			
		LEPS6		LEPS10	
		LEPS6□-25	LEPS6□-50	LEPS10□-25	LEPS10□-50
Horizontal/Bottom	X 				
	Y 				
	Z 				
Wall	X 				
	Y 				
	Z 				

* This graph shows the amount of allowable overhanging (guide unit) when the center of gravity of the workpiece overhangs in one direction. When selecting the overhang, refer to the Electric Actuator Selection Software for confirmation, <http://www.smcworld.com>

Dynamic Allowable Moment

Acceleration/Deceleration — 3000 mm/s²

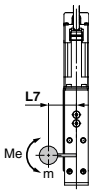
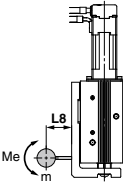
Orientation	Load overhanging direction m : Work load [kg] Me: Dynamic allowable moment [N·m] L : Overhang to the work load center of gravity [mm]	Model			
		LEPS6		LEPS10	
		LEPS6□-25	LEPS6□-50	LEPS10□-25	LEPS10□-50
Vertical	 <p style="text-align: center;">Y</p>				
	 <p style="text-align: center;">Z</p>				

LEPS Series

Step Motor (Servo/24 VDC)

Static Allowable Moment

Model	Allowable moment [N·m]		
	Pitch moment	Yaw moment	Roll moment
	M_p	M_y	M_r
LEPS6	1.07	1.07	2.51
LEPS10	2.55	2.55	5.47

Traveling Parallelism

Traveling parallelism	Stroke [mm]	
	25	50
	0.05 mm or less	0.1 mm or less

Table Deflection (Reference Value)

* These values are initial guideline values.

Table displacement due to pitch moment load (marked with the arrow)

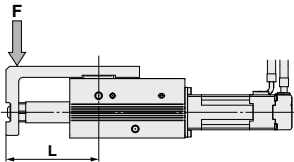

Table displacement due to yaw moment load (marked with the arrow)

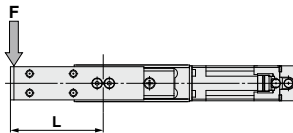
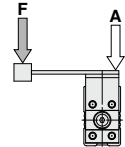

Table displacement due to roll moment load (marked with A)



Distance L [mm]

Model	LEPS6		LEPS10	
Stroke [mm]	25	50	25	50
Distance L [mm]	53.0	77.0	59.5	82.0

LEPS6

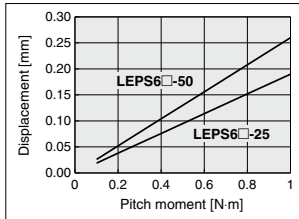

LEPS6

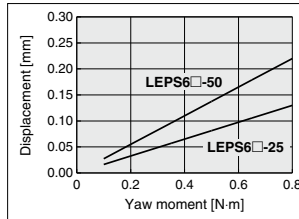

LEPS6

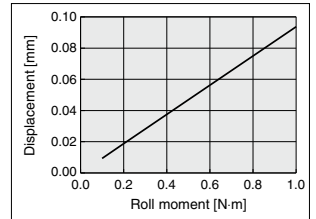

LEPS10

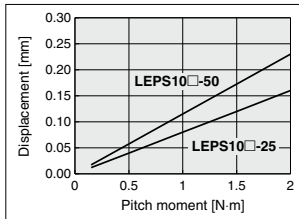

LEPS10

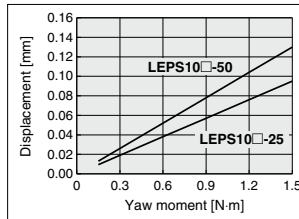

LEPS10

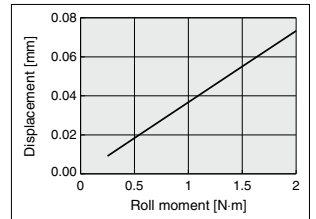

Electric Actuator Miniature Slide Table Type

LEPS Series LEPS6, 10



Applicable to the
LEC□ series

Refer to page 391-1 for the communication protocols EtherCAT®, EtherNet/IP™, PROFINET, DeviceNet™, and IO-Link.

How to Order

LEPS **10** **□** **K** - **50** **□** - **R1** **6N** **1** **□**

①
②
③
④
⑤
⑥
⑦
⑧
⑨

① Size

6
10

② Motor size

Symbol	Motor size	Applicable size
Nil	Basic	6, 10
L	Compact	10

③ Lead screw type [mm]

Symbol	Screw lead	
	LEPS6	LEPS10
K	4	5
J	8	10

④ Stroke [mm]

Symbol	Stroke
25	25
50	50

⑤ Motor cable mounting direction

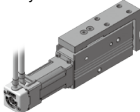
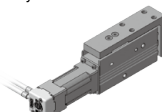
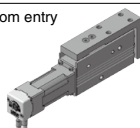
Nil	Top entry 	L	Entry on the left side 
	Bottom entry 		R

⚠ Caution

[CE-compliant products]

① EMC compliance was tested by combining the electric actuator LEP series and the controller LEC series.

The EMC depends on the configuration of the customer's control panel and the relationship with other electrical equipment and wiring. Therefore, conformity to the EMC directive cannot be certified for SMC components incorporated into the customer's equipment under actual operating conditions. As a result, it is necessary for the customer to verify conformity to the EMC directive for the machinery and equipment as a whole.

② CC-Link direct input type (LECPMJ) is not CE-compliant.

[UL-compliant products]

When conformity to UL is required, the electric actuator and controller/driver should be used with a UL1310 Class 2 power supply.

The actuator and controller/driver are sold as a package.

Confirm that the combination of the controller/driver and the actuator is correct.

<Check the following before use.>

- Check the actuator label for model number. This matches the controller/driver.
- Check Parallel I/O configuration matches (NPN or PNP).

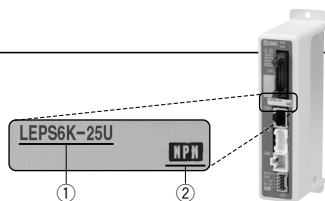

* Refer to the operation manual for using the products. Please download it via our website, <http://www.smcworld.com>



6 Actuator cable type/length

Nil	Without cable
S1	Standard cable 1.5 m
S3	Standard cable 3 m
S5	Standard cable 5 m
R1	Robotic cable 1.5 m
R3	Robotic cable 3 m
R5	Robotic cable 5 m
R8	Robotic cable 8 m ^{*1}
RA	Robotic cable 10 m ^{*1}
RB	Robotic cable 15 m ^{*1}
RC	Robotic cable 20 m ^{*1}

*1 Produced upon receipt of order (Robotic cable only)

*2 The standard cable should only be used on fixed parts.

For use on moving parts, select the robotic cable.

9 Controller/Driver mounting

Nil	Screw mounting
D	DIN rail mounting*

* DIN rail is not included. Order it separately.

7 Controller/Driver type^{*1}

Nil	Without controller/driver	
6N	LECP6	NPN
6P	(Step data input type)	PNP
1N	LECP1	NPN
1P	(Programless type)	PNP
MJ	LECPMJ ^{*2} (CC-Link direct input type)	—
AN	LECPA ^{*3}	NPN
AP	(Pulse input type)	PNP

*1 For details about controller/driver and compatible motor, refer to the compatible controller/driver below.

*2 Not applicable to CE.

*3 When pulse signals are open collector, order the current limiting resistor (LEC-PA-R-□) on page 596 separately.

8 I/O cable length [m]^{*1}, Communication plug





Nil	Without cable (Without communication plug connector) ^{*3}
1	1.5
3	3 ^{*2}
5	5 ^{*2}
S	Straight type communication plug connector ^{*3}
T	T-branch type communication plug connector ^{*3}

*1 When "Without controller/driver" is selected for controller/driver types, I/O cable cannot be selected. Refer to page 568 (For LECP6), page 582 (For LECP1) or page 596 (For LECPA) if I/O cable is required.

*2 When "Pulse input type" is selected for controller/driver types, pulse input usable only with differential. Only 1.5 m cables usable with open collector.

*3 For the LECPMJ, only "Nil", "S" and "T" are selectable since I/O cable is not included.

Compatible Controller/Driver

Type	Step data input type	CC-Link direct input type	Programless type	Pulse input type
				
Series	LECP6	LECPMJ	LECP1	LECPA
Features	Value (Step data) input Standard controller	CC-Link direct input	Capable of setting up operation (step data) without using a PC or teaching box	Operation by pulse signals
Compatible motor	Step motor (Servo/24 VDC)			
Maximum number of step data	64 points		14 points	—
Power supply voltage	24 VDC			
Reference page	Page 560	Page 600	Page 576	Page 590

Electric Actuator Miniature Slide Table Type

LEPS Series LEPS6, 10



Applicable to the
JXC□ series

How to Order

Refer to page 390 for the communication protocol CC-Link.

LEPS **10** **□** **K** - **50** **□** - **R1** **CD17T**

①
②
③
④
⑤
⑥
⑦

① Size

6
10

② Motor size

Symbol	Motor size	Applicable size
Nil	Basic	6, 10
L	Compact	10

③ Lead screw type [mm]

Symbol	Screw lead	
	LEPS6	LEPS10
K	4	5
J	8	10

④ Stroke [mm]

Symbol	Stroke
25	25
50	50

⑤ Motor cable mounting direction

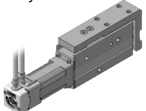
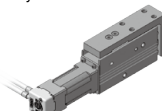
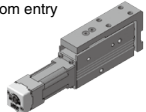
Nil	Top entry 	L	Entry on the left side 
	Bottom entry 		R

⚠ Caution

[CE-compliant products]

EMC compliance was tested by combining the electric actuator LE series and the JXCE1/91/P1/D1/L1 series.

The EMC depends on the configuration of the customer's control panel and the relationship with other electrical equipment and wiring. Therefore, conformity to the EMC directive cannot be certified for SMC components incorporated into the customer's equipment under actual operating conditions. As a result, it is necessary for the customer to verify conformity to the EMC directive for the machinery and equipment as a whole.



6 Actuator cable type/length

Nil	Without cable
S1	Standard cable 1.5 m
S3	Standard cable 3 m
S5	Standard cable 5 m
R1	Robotic cable 1.5 m
R3	Robotic cable 3 m
R5	Robotic cable 5 m
R8	Robotic cable 8 m ^{*1}
RA	Robotic cable 10 m ^{*1}
RB	Robotic cable 15 m ^{*1}
RC	Robotic cable 20 m ^{*1}

*1 Produced upon receipt of order (Robotic cable only)

*2 The standard cable should only be used on fixed parts.
For use on moving parts, select the robotic cable.

7 Controller

Nil	Without controller
C□1□□	With controller

C D 1 7 T

Communication protocol ●

E	EtherCAT®
9	EtherNet/IP™
P	PROFINET
D	DeviceNet™
L	IO-Link

For single axis ●

● Communication plug connector for DeviceNet™

Nil	Without plug connector
S	Straight type
T	T-branch type





* Select "Nil" for anything other than DeviceNet™

● Mounting

7	Screw mounting
8*	DIN rail mounting

* The DIN rail is not included. It must be ordered separately. (Refer to page 603-8.)

Compatible Controller

Type					
Series	JXCE1	JXC91	JXCP1	JXCD1	JXCL1
Features	EtherCAT® direct input	EtherNet/IP™ direct input	PROFINET direct input	DeviceNet™ direct input	IO-Link direct input
Compatible motor	Step motor (Servo/24 VDC)				
Maximum number of step data	64 points				
Power supply voltage	24 VDC				
Reference page	Page 603-5				

LEPS Series

Step Motor (Servo/24 VDC)



Weight

Model	LEPS6	
Stroke [mm]	25	50
Product weight [kg]	Basic	0.29 0.35

Model	LEPS10	
Stroke [mm]	25	50
Product weight [kg]	Basic	0.56 0.65
	Compact	0.50 0.59

Specifications

Model		LEPS6		LEPS10		
Stroke [mm]		25, 50				
Screw lead [mm]		4, 8, 5, 10				
Pushing force [N]	Basic	14 to 20	7 to 10	25 to 50	12.5 to 25	
	Compact	—	—	24 to 40	12 to 20	
Work load [kg]	Horizontal	Basic	1.0	0.75	2.0	1.5
		Compact	—	—	2.0	1.5
	Vertical	Basic	0.5	0.25	1.5	1.0
		Compact	—	—	1.5	1.0
Speed [mm/s]	Horizontal	Basic	10 to 150	20 to 300	10 to 200	20 to 350
		Compact	—	—	10 to 200	20 to 350
	Vertical	Basic	10 to 150	20 to 300	10 to 150	20 to 300
		Compact	—	—	10 to 150	20 to 300
Pushing speed [mm/s]		10	20	10	20	
Acceleration/Deceleration [mm/s ²]		3000				
Backlash [mm]		0.2 or less				
Positioning repeatability [mm]		±0.05				
Lost motion [mm]		0.2 or less				
Impact/Vibration resistance [m/s ²]		50/20				
Actuation type		Slide screw				
Guide type		Linear guide				
Max. operating frequency [c.p.m.]		60				
Operating temperature range [°C]		5 to 40				
Operating humidity range [%RH]		90 or less (No condensation)				
Motor size		□20		□28		
Motor type		Step motor (Servo/24 VDC)				
Encoder (Angular displacement sensor)		Incremental A/B phase (800 pulse/rotation)				
Rated voltage [V]		24 VDC ±10%				
Electric specifications	Power consumption [W]	Basic	12	28		
		Compact	—	22		
	Standby power consumption when operating [W]	Basic	11	22		
		Compact	—	16		
	Max. instantaneous power consumption [W]	Basic	22	55		
	Compact	—	45			

Note 1) Pushing force accuracy is LEPS6: ±30% (F.S.), LEPS10: ±25%(F.S.).

Refer to pages 396 and 397 for the detailed setting range and precautions. The pushing force and the duty ratio change according to the set value. Check "Set Value of Pushing Force-Force Graph (Guide)" on page 385 and [14] on page 397.

Note 2) The maximum value of the work load for the positioning operation. Check "Dynamic Allowable Moment" graph for the allowable moment of the guide on pages 386 and 387.

Note 3) Speed changes according to the work load. Check "Speed-Work Load Graph (Guide)" on page 385.

Note 4) When the stroke is 25 mm, the maximum speed will be 250 mm/sec.

Note 5) Set to the pushing force when pushing.

Note 6) The speed and force may change depending on the cable length, load and mounting conditions. Furthermore, if the cable length exceeds 5 m, then it will decrease by up to 10% for each 5 m. (At 15 m: Reduced by up to 20%)

Note 7) A reference value for correcting an error in reciprocal operation.

Note 8) Impact resistance: No malfunction occurred when the actuator was tested with a drop tester in both an axial direction and a perpendicular direction to the lead screw. (Test was performed with the actuator in the initial state.)

Vibration resistance: No malfunction occurred in a test ranging between 45 to 2000 Hz. Test was performed in both an axial direction and a perpendicular direction to the lead screw. (Test was performed with the actuator in the initial state.)

Note 9) The power consumption (including the controller) is for when the actuator is operating.

Note 10) The standby power consumption when operating (including the controller) is for when the actuator is stopped in the set position during operation. Except during the pushing operation.

Note 11) The maximum instantaneous power consumption (including the controller) is for when the actuator is operating. This value can be used for the selection of the power supply.

Construction

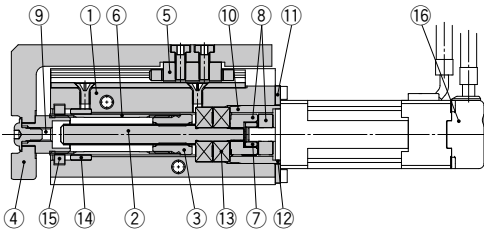

Component Parts

No.	Description	Material	Note
1	Body	Aluminum alloy	Anodized
2	Screw shaft	Stainless steel	Heat treatment + Specially treated
3	Screw nut	Stainless steel	Heat treatment + Specially treated
4	Table	Aluminum alloy	Anodized
5	Linear guide	—	—
6	Rod	Stainless steel	—
7	Spider	NBR	—
8	Hub	Aluminum alloy	—
9	Socket	Free cutting carbon steel	Nickel plating
10	Bearing stopper	Size 6: Aluminum alloy Size 10: Carbon steel	—
11	Motor plate	Aluminum alloy	Anodized
12	Guide ring	Aluminum alloy	Size 10 only
13	Bearing	—	—
14	Bushing	Oil impregnated sintered copper alloy	—
15	Soft wiper	—	—
16	Step motor (Servo/24 VDC)	—	—

LEPS Series

Step Motor (Servo/24 VDC)

Dimensions

LEPS10

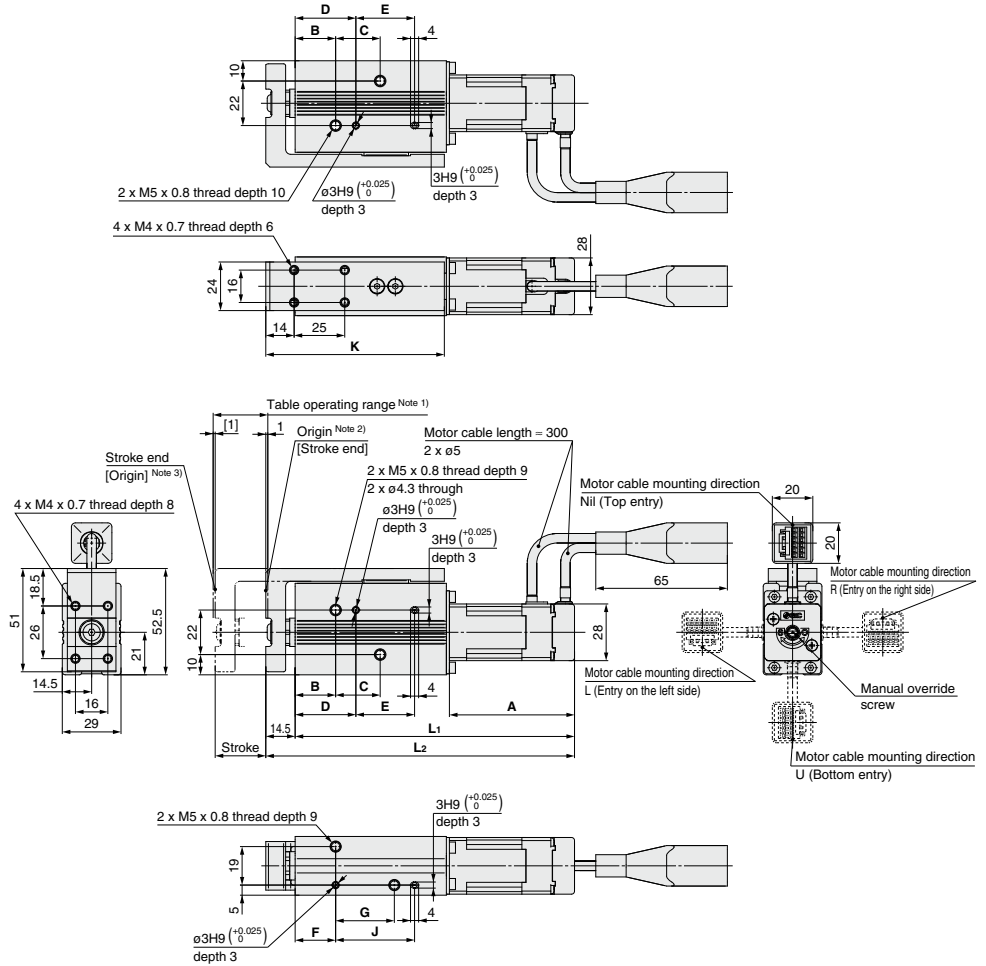

Note 1) Range within which the table can move when it returns to origin.

Note 2) Position after return to origin.

Note 3) [] for when the direction of return to origin has changed.

Dimensions

Model	L1	L2	A	B	C	D	E	F	G	J	K
LEPS10□-25□	138	152.5	61.8	20	22	30	29	20	29	39	88.2
LEPS10□-50□	163	177.5		24	43	34	50	24	50	60	113.2
LEPS10L□-25□	124	138.5	47.8	20	22	30	29	20	29	39	88.2
LEPS10L□-50□	149	163.5		24	43	34	50	24	50	60	113.2



LEPY/LEPS Series

Specific Product Precautions 1

Be sure to read this before handling the products. Refer to back page 50 for Safety Instructions and pages 3 to 8 for Electric Actuator Precautions.

Design/Selection

Warning

- Do not apply a load in excess of the specification limits.**
Select a suitable actuator by work load and allowable lateral load on the rod end. If the product is used outside of the specification limits, the eccentric load applied to the rod will be excessive and have adverse effects such as creating play on the sliding parts of the rod, degrading accuracy and shortening the life of the product.
- Do not use the product in applications where excessive external force (including vibration) or impact force is applied to it.**
Do not apply impact and vibration outside of the specifications; it may lead to a malfunction.
- If gravity acts on the workpiece due to vertical mounting, it may drop due to its own weight depending on the conditions when the product is not energized (SVON signal is OFF) or stopped (EMG is not energized).**
- Power failure may result in a decrease in the pushing force; ensure that safety measures are in place to prevent injury to the operator or damage to the equipment.**
When the product is used for clamping, the clamping force could be decreased due to power failure, potentially creating a hazardous situation in which the workpiece is released.
- This product cannot be used as a stopper.**
Excessive load acts on the actuator, which adversely affects the operation and the life of the product.

Mounting

Warning

- Do not drop or hit the actuator to avoid scratching and denting the mounting surfaces.**
Even slight deformation can cause the deterioration of accuracy and operation failure.
- When mounting workpieces or jigs to the rod end, hold the flats of the rod end with a wrench so that the rod does not rotate (Rod type only).**
When attaching a nut or workpiece to the end of the rod, hold the flats of the rod end with a wrench (the rod should be fully retracted). Do not apply tightening torque to the rod non-rotating mechanism. The rod is manufactured to precise tolerances, so even a slight deformation may cause a malfunction and damage.

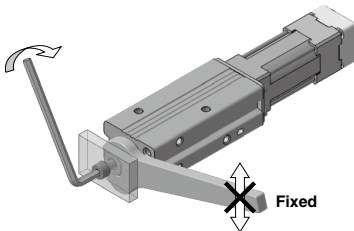

Mounting

Warning

- When mounting a bolt, workpiece or jig to the rod end, the bolt should be tightened with a torque within the specified range (Rod type only).**
Tightening to a torque higher than the specified value may cause a malfunction due to deformation of the component, whilst under-tightening can cause displacement of the mounting position or in extreme conditions detaching of the workpiece. If the bolt is screwed in more than the maximum depth, the lead screw will be damaged, leading to operation failure.

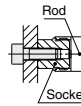

Model	Thread size	Max. tightening torque [N·m]	Max. screw-in depth [mm]	Rod end width across flats [mm]
LEPY6	M4 x 0.7	1.4	7	10
LEPY10	M5 x 0.8	3.0	9	12

- The angular position of the rod end flats cannot be changed because the rod has a non-rotating mechanism inside (Rod type only).**
The angular position of the rod end flats is not specified; it depends on the actuator type.
The rod rotates slightly due to the clearance of the non-rotating mechanism: Install the bolt or workpiece with consideration to the rotation.
- When attaching the workpiece to the table, hold the table and tighten the screws with a torque within the specified range (Slide table type only).**
The table is supported by a linear guide, do not apply impact or moment when mounting the work load.
If the screws are screwed to more than the maximum screw-in depth, it may lead to a malfunction due to damage of the linear guide or body.

Top mounting

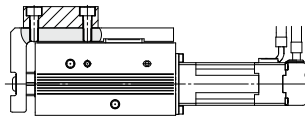

Model	Screw size	Max. tightening torque [N·m]	Max. screw-in depth [mm]
LEPS6	M4 x 0.7	1.4	6
LEPS10	M4 x 0.7	1.4	6

Front mounting

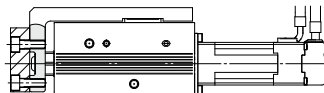

Model	Screw size	Max. tightening torque [N·m]	Max. screw-in depth [mm]
LEPS6	M4 x 0.7	1.4	7
LEPS10	M4 x 0.7	1.4	8



LEPY/LEPS Series Specific Product Precautions 2

Be sure to read this before handling the products. Refer to back page 50 for Safety Instructions and pages 3 to 8 for Electric Actuator Precautions.

Mounting

Warning

6. When mounting the product, tighten the mounting screws within the specified torque range.

Tightening the screws with a higher torque than recommended may cause a malfunction, whilst the tightening with a lower torque can cause the displacement of the mounting position or in extreme conditions the actuator could become detached from its mounting position.

Side mounting (Body mounting through-hole)

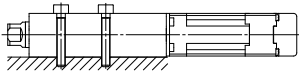

Model	Screw size	Max. tightening torque [N·m]
LEPY6	M3 x 0.5	0.9
LEPS6		
LEPY10	M4 x 0.7	1.4
LEPS10		

Side mounting (Body tapped)

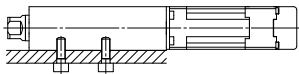

Model	Screw size	Max. tightening torque [N·m]	Max. screw-in depth [mm]
LEPY6	M4 x 0.7	1.4	7
LEPS6			
LEPY10	M5 x 0.8	3.0	9
LEPS10			

Bottom mounting (Body tapped)

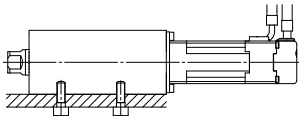

Model	Screw size	Max. tightening torque [N·m]	Max. screw-in depth [mm]
LEPY6	M4 x 0.7	1.4	5
LEPS6			
LEPY10	M5 x 0.8	3.0	9
LEPS10			

Rod side mounting (Rod type only)

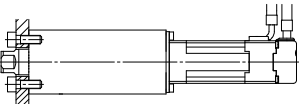

Model	Screw size	Max. tightening torque [N·m]	Max. screw-in depth [mm]
LEPY6	M4 x 0.7	1.4	7
LEPY10	M5 x 0.8	3.0	9

7. When it is necessary to operate the product by the manual override screw, check the position of the manual override and leave necessary space.

Do not apply excessive torque to the manual override screw. This may lead to damage and malfunction.

Handling

Caution

1. When the pushing operation is used, be sure to set to [Pushing operation].

Also, do not hit the workpiece in positioning operation or in the range of positioning operation.

It may damage and malfunction. If the operation is interrupted or stopped during the cycle: When the pushing operation command is output immediately after restarting the operation, the direction of movement depends on the position of restart.

2. Use the product within the specified pushing speed range for the pushing operation.

It may lead to damage and malfunction.

Model	Lead	Pushing speed [mm/sec]
LEPY6	4	10
LEPS6	8	20
LEPY10	5	10
LEPS10	10	20

3. For the pushing operation, ensure that the force is applied in the direction of the rod axis.

4. The moving force should be the initial value.

If the moving force is set below the initial value, it may cause an alarm.

Model	Motor size	Moving force [%]
LEPY6	Basic	150
LEPS6		
LEPY10	Compact	150
LEPS10		

5. The actual speed of this actuator is affected by the load.

Check the model selection section of the catalog.

6. Do not scratch or dent the sliding parts of the rod, by striking or attaching objects.

The rod is manufactured to precise tolerances, even a slight deformation may cause malfunction.

7. Avoid using the electric actuator in such a way that rotational torque would be applied to the rod.

It may cause deformation of the non-rotating sliding part, leading to clearance in the internal guide or an increase in the sliding resistance. Refer to the table below for the approximate values of the allowable range of rotational torque.

Allowable rotational torque [N·m] or less	LEPY6□	LEPY10□
	0.04	0.08



LEPY/LEPS Series Specific Product Precautions 3

Be sure to read this before handling the products. Refer to back page 50 for Safety Instructions and pages 3 to 8 for Electric Actuator Precautions.

Handling

⚠ Caution

8. Do not operate by fixing the rod and moving the actuator body.

Excessive load will be applied to the rod, leading to damage to the actuator and reduced the life of the product.

9. Return to origin

- 1) Do not apply a load, impact or resistance in addition to the transferred load during return to origin.
Additional force will cause the displacement of the origin position since it is based on detected motor torque.
- 2) When the return to origin is set with <Basic parameter> [Origin offset], it is necessary to change the current position of the product. Recheck the value of step data.
- 3) It is recommended to set the directions of return to origin and pushing in the same direction in order to enhance the measurement accuracy during pushing operation.

10. There is no backlash effect in pushing operation.

The return to origin is done by the pushing operation.
The position can be displaced by the effect of the backlash during the positioning operation.
Take the backlash into consideration when setting the position.

<Backlash>

Model	Backlash [mm]
LEPY6	0.2 or less
LEPS6	0.2 or less
LEPY10	0.2 or less
LEPS10	0.2 or less

11. Do not hit at the stroke end except during return to origin.

This may damage the inner parts.

12. INP output signal

- 1) Positioning operation
When the product comes within the set range by step data [In position], the INP output signal will turn on.
Initial value: Set to [0.50] or higher.
- 2) Pushing operation
When the effective pushing force exceeds the step data [Trigger LV], the INP output signal will turn on.
When [Pushing force] setting and [Trigger LV] are set less than [Pushing force], use the product within the specified range of [Pushing force] and [Trigger LV].
 - a) To ensure that the actuator pushes the workpiece with the set [Pushing force], it is recommended that the [Trigger LV] be set to the same value as the [Pushing force].
 - b) If the [Trigger LV] is set lower than the [operation pushing force (current pushing force) for the pushing operation], the pushing force will exceed the trigger LV from the pushing start position and the INP output signal will turn on before pushing the workpiece. Increase the pushing force, or change the work load so that the current pushing force becomes smaller than the trigger LV.

<Pushing force and trigger LV range>

Model	Motor size	Set value of pushing force [%]
LEPY6 LEPS6	Basic	70 to 100
LEPY10 LEPS10	Basic	50 to 100
	Compact	60 to 100

13. In pushing operation, set the product to a position of at least 0.5 mm away from a workpiece. (This position is referred to as a pushing start position.)

The following alarms may be generated and operation may become unstable.

- a. "Posn failed" alarm is generated.
The product cannot reach a pushing start position due to variation in the width of workpieces.
- b. "Pushing ALM" alarm is generated.
The product is pushed back from a pushing start position after starting to push.
- c. "Deviation over flow" alarm is generated.
Displacement exceeding the specified value is generated at the pushing start position.

14. For the pushing operation, use the product within the duty ratio range below.

The duty ratio is a ratio at the time that can keep being pushed.

Model	Motor size	Set value of pushing force [%]	Duty ratio [%]	Continuous pushing time [minutes]
LEPY6 LEPS6	Basic	70	100	—
		80	70	10
		100	50	5

Model	Motor size	Set value of pushing force [%]	Duty ratio [%]	Continuous pushing time [minutes]
LEPY10 LEPS10	Basic	60 or less	100	—
		70	30	3
		100	15	1

Model	Motor size	Set value of pushing force [%]	Duty ratio [%]	Continuous pushing time [minutes]
LEPY10 LEPS10	Compact	70 or less	100	—
		80	70	10
		100	50	5

15. When mounting the product, keep a 40 mm or longer diameter for bends in the motor cable.

Maintenance

⚠ Warning

1. Ensure that the power supply is stopped and the workpiece is removed before starting maintenance work or replacement of the product.