

BI3-M12-AD4X-0.2-RS4.23T

Inductive Sensor

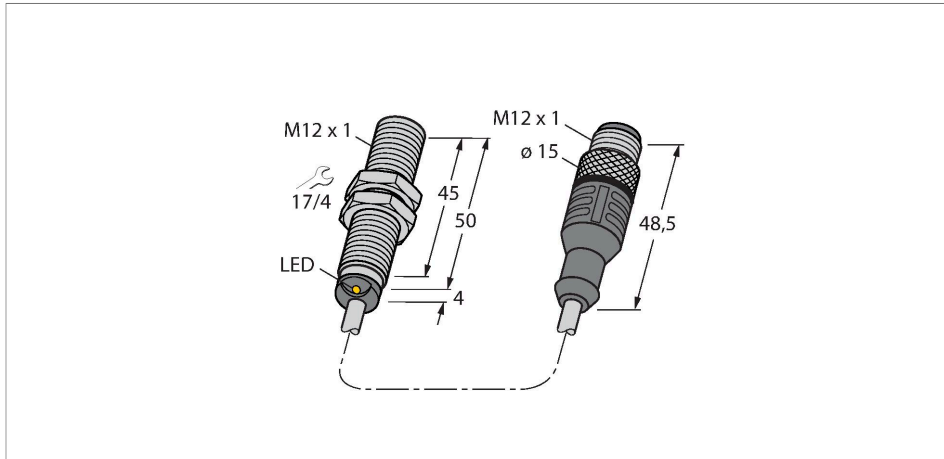

Features

- M12 × 1 threaded barrel
- Chrome-plated brass
- DC 2-wire, 10...65 VDC
- NO contact
- Cable with male end

Technical data

Type	BI3-M12-AD4X-0.2-RS4.23T
ID	4405096
General data	
Rated switching distance	3 mm
Mounting conditions	Flush
Secured operating distance	≤ (0.81 × S _n) mm
Correction factors	St37 = 1; Al = 0.3; stainless steel = 0.7; Ms = 0.4
Repeat accuracy	≤ 2 % of full scale
Temperature drift	≤ ±10 %
Hysteresis	1...15 %
Electrical data	
Operating voltage	10...65 VDC
Residual ripple	≤ 10 % U _{ss}
DC rated operational current	≤ 100 mA
Residual current	≤ 0.6 mA
Isolation test voltage	≤ 0.5 kV
Short-circuit protection	yes / Cyclic
Voltage drop at I _o	≤ 5 V
Wire breakage/Reverse polarity protection	Complete
Output function	2-wire, NO contact, 2-wire
Smallest operating current	≥ 3 mA
Switching frequency	1 kHz

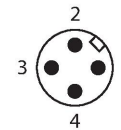
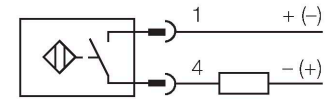

Functional principle

Inductive sensors detect metal objects contactless and wear-free. For this, they use a high-frequency electromagnetic AC field that interacts with the target. Inductive sensors generate this field via an RLC circuit with a ferrite coil.

Technical data

Mechanical data	
Design	Threaded barrel, M12 × 1
Dimensions	54 mm
Housing material	Metal, CuZn, Chrome-plated
Active area material	Plastic, PA12-GF30
End cap	Plastic, EPTR
Material coupling nut	metal, CuZn, nickel-plated
Max. tightening torque of housing nut	10 Nm
Electrical connection	Cable with connector, M12 × 1
Cable quality	Ø 5.2 mm, LifYY, PVC, 0.2 m
Core cross-section	2 x 0.34 mm ²
Environmental conditions	
Ambient temperature	-25...+70 °C
Vibration resistance	55 Hz (1 mm)
Shock resistance	30 g (11 ms)
Protection class	IP67
MTTF	2283 years acc. to SN 29500 (Ed. 99) 40 °C
Switching state	LED, Yellow

Mounting instructions

Mounting instructions/Description

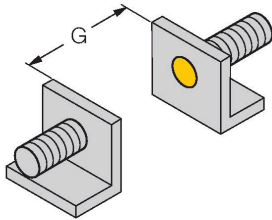

Distance D 24 mm

Distance W 3 x Sn

Distance T 3 x B

Distance S 1.5 x B

Distance G 6 x Sn

Diameter active area B \varnothing 12 mm

Accessories

QM-12

6945101

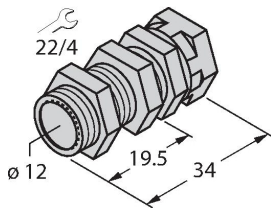

Quick-mount bracket with dead-stop; material: Chrome-plated brass. Male thread M16 x 1. Note: The switching distance of the proximity switches may change when using quick-mount brackets.

BST-12B

6947212

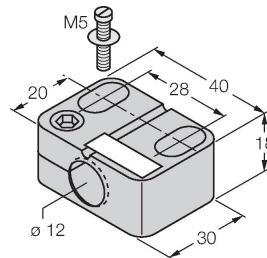

Mounting clamp for threaded barrel sensors, with dead-stop; material: PA6

MW-12

6945003

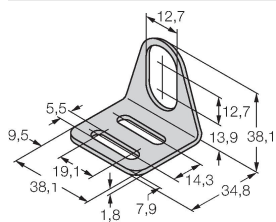

Mounting bracket for threaded barrel sensors; material: Stainless steel A2 1.4301 (AISI 304)

BSS-12

6901321

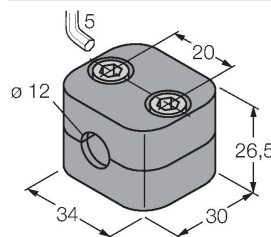

Mounting clamp for smooth and threaded barrel sensors; material: Polypropylene