

PKG 4M-20

Actuator and Sensor Cordset – Connection Cable

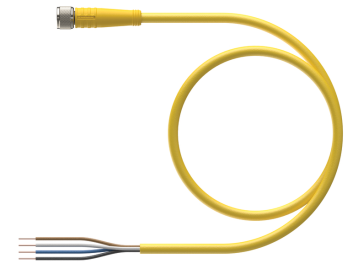
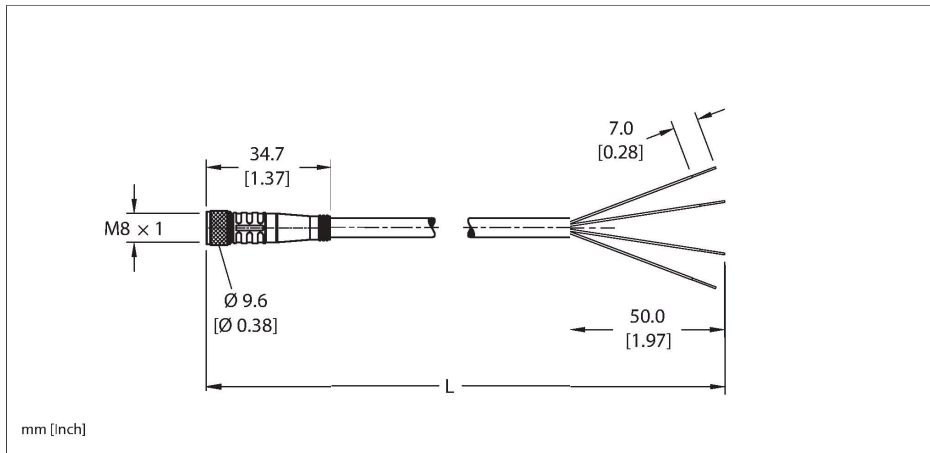

Technical data

Type	PKG 4M-20
ID	U99-10796
Connector A	Female, M8 × 1, Straight
Design specification	Acc. to IEC 61076-2-104
Number of contacts	4
Contacts	Brass, CuZn, Gold-plated
Contact carriers	Plastic, Nylon or TPU, Black
Connector body	Plastic, TPU, Yellow
Coupling nut	Brass, CuZn, Nickel-plated
Connector seal	O-ring, Plastic, FKM/FPM
Tightening torque (range)	0.4 ... 0.8 Nm (note max. torque of mating connector!)
Mechanical life	> 100 Mating cycles
Pollution degree	3
Protection class (When coupled)	IP68
	NEMA: 1, 3, 4, 6P
Cable data	
Cable ID	RF50697
Total number of conductors	4
Cable diameter	Ø 4.39 mm
Length (L)	20 m, (+50mm or 4% of length/-0.0, Whichever is greater)
Cable jacket	PVC, Yellow
Conductor diameter	0.039 "
Conductor material	TC (tinned copper)

Features



- M8, Female, Straight, 4-pin
- Threaded Connector
- General Purpose Cable
- Yellow PVC jacket, 4X26 AWG
- -40 Cold Bend Rating
- Flame Ratings: UL1061, CSA FT1

Cable cross section

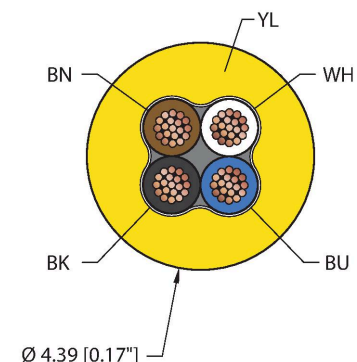

Contact assignment

Technical data

Connector A

Conductor insulation material	PVC
Conductor size	4 x 26 AWG [Similar to 0.14 mm ²]
Number of strands x O.D.	19 x 38 AWG
Conductor colors	BN, WH, BU, BK



Electrical properties at +20 °C	
Rated voltage	125 VAC/DC
Current	2 A

Circuit Diagram

Mechanical and chemical properties	
Bending radius (static)	≥ 5 x Ø
Bending radius (dynamic)	≥ 10 x Ø
UL cold bend rating	-40 °C
Ambient temperature range (static)	-40 °C...+105 °C
Ambient temperature range (dynamic)	5 °C...+105 °C
Temperature range (installation)	-10 °C...+105 °C



Approval	
Approvals	UL 2238 CSA C22.2 No. 182.3 CE UKCA RoHS

Note	
	- Flex ratings may be reduced if used in extreme temperatures, exposure to certain chemicals, operating above the rated cycle speed, or operating below the rated cable bend radius.
	- We reserve the right to make technical alterations without prior notice.