

BI6-EG12FE-AN6X-H1141

Inductive Sensor – Stainless Steel Front

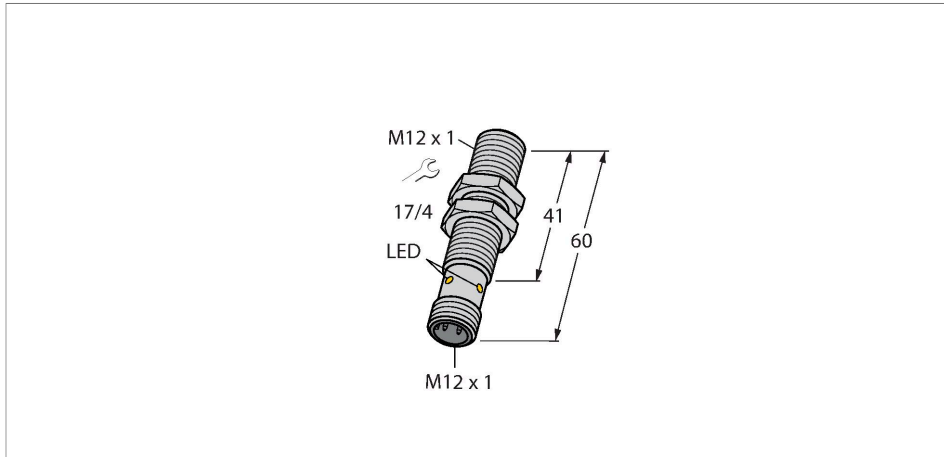

Features

- Threaded barrel, M12 x 1
- Stainless steel, 1.4305
- DC 3-wire, 10...30 VDC
- NO contact, NPN output
- M12 x 1 male connector

Wiring diagram

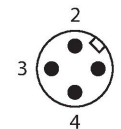
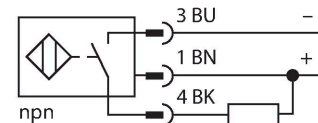

Technical data

Type	BI6-EG12FE-AN6X-H1141
ID	4614714
General data	
Rated switching distance	6 mm
Mounting conditions	Flush
Secured operating distance	$\leq (0.81 \times S_n)$ mm
Correction factors	St37 = 1; Al = 1; Cu=0.85; stainless steel 1mm = 0.5; stainless steel 2mm = 0.9; Ms = 1.3
Repeat accuracy	$\leq 5\%$ of full scale
Temperature drift	$\leq \pm 10\%$
Hysteresis	15 %
Electrical data	
Operating voltage	10...30 VDC
Residual ripple	$\leq 20\% U_{ss}$
DC rated operational current	≤ 200 mA
No-load current	10 mA
Residual current	≤ 0.1 mA
Isolation test voltage	≤ 0.5 kV
Short-circuit protection	yes / Cyclic
Voltage drop at I_o	≤ 2 V
Wire breakage/Reverse polarity protection	yes / Complete
Output function	3-wire, NO contact, NPN
Switching frequency	0.6 kHz

Functional principle

The inductive all-metal switches operate on the basis of the electromagnetic pulse method. Unlike standard inductive sensors, the magnetic field is not generated through oscillation but through short, periodic current pulses flowing through the coil. The magnetic field induces voltage in the object to be detected, which, for its part creates a current flow in this object. After switching off the current pulse, the current in the object also drops, now inducing voltage back in the emitter coil. This voltage is the wanted signal and remains unaffected by energy dissipation in the magnetic field. Only non-ferromagnetic or poorly conductive metals provide a low signal.

Technical data

Mechanical data	
Design	Threaded barrel, M12 × 1
Dimensions	60 mm
Housing material	Stainless steel, 1.4305 (AISI 303)
Active area material	Stainless steel, 1.4305 (AISI 303)
Admissible pressure on front cap	≤ 80 bar
Max. tightening torque of housing nut	20 Nm
Electrical connection	Connector, M12 × 1
Environmental conditions	
Ambient temperature	-25...+70 °C
Vibration resistance	55 Hz (1 mm)
Shock resistance	30 g (11 ms)
Protection class	IP68 IP69K
MTTF	336 years acc. to SN 29500 (Ed. 99) 20 °C
Switching state	LED, Yellow, LED flashing: 0.8 s, < s ≤ s,

Mounting instructions

Mounting instructions/Description

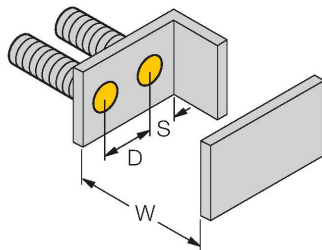
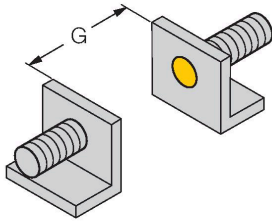

Distance D 40 mm

Distance W 18 mm

Distance T 36 mm

Distance S 12 mm

Distance G 36 mm

Diameter active area B \varnothing 12 mm

The following reduction factors apply when flush-mounted in:
 Steel: 0.7
 Aluminium: 1.15
 Brass: 1.05
 Stainless steel: 0.8

Accessories

MW-12

6945003

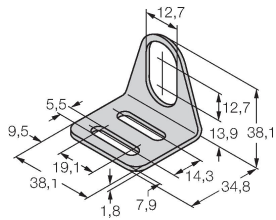

Mounting bracket for threaded barrel sensors; material: Stainless steel A2 1.4301 (AISI 304)

BSS-12

6901321

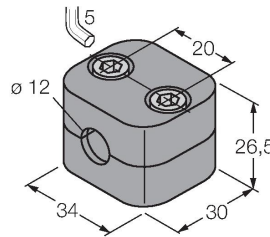

Mounting clamp for smooth and threaded barrel sensors; material: Polypropylene