

BI15U-EM30WD-AP6X 7M

Inductive Sensor – For the Food Industry

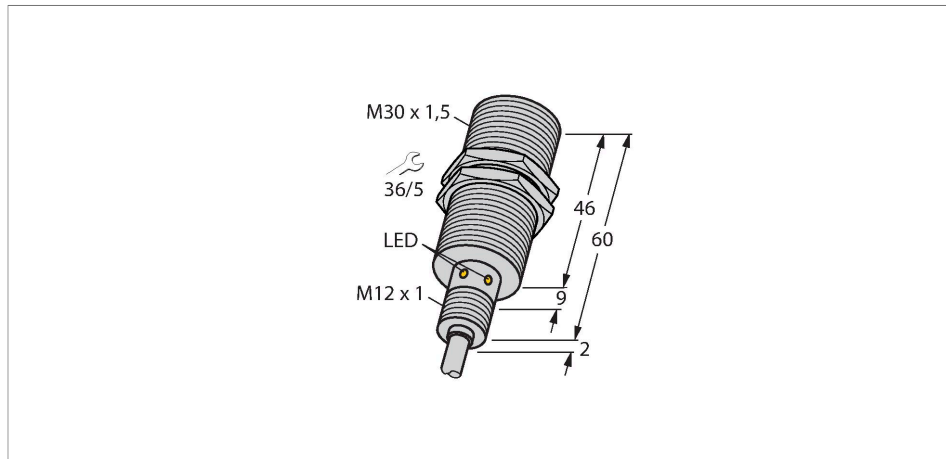

Features

- Threaded barrel, M30 x 1.5
- Stainless steel, 1.4404
- Front cap made of liquid crystal polymer
- Factor 1 for all metals
- Resistant to magnetic fields
- For temperatures of -40 °C...+100 °C
- High protection class IP69K for harsh environments
- Special double-lip seal
- Protection against all common acidic and alkaline cleaning agents
- Laser engraved label, permanently legible
- DC 3-wire, 10...30 VDC
- NO contact, PNP output
- Cable connection

Technical data

Type	BI15U-EM30WD-AP6X 7M
ID	1636746
General data	
Rated switching distance	15 mm
Mounting conditions	Flush
Secured operating distance	$\leq (0.81 \times S_n)$ mm
Repeat accuracy	$\leq 2\%$ of full scale
Temperature drift	$\leq \pm 10\%$ $\leq \pm 20\%$, $\leq -25\text{ °C}$, $\geq +70\text{ °C}$
Hysteresis	3...15 %
Electrical data	
Operating voltage	10...30 VDC
Residual ripple	$\leq 10\%$ U_{ss}
DC rated operational current	≤ 200 mA
No-load current	25 mA
Residual current	≤ 0.1 mA
Isolation test voltage	≤ 0.5 kV
Short-circuit protection	yes / Cyclic
Voltage drop at I_o	≤ 1.8 V
Wire breakage/Reverse polarity protection	yes / Complete
Output function	3-wire, NO contact, PNP
DC field stability	300 mT
AC field stability	300 mT _{ss}
Insulation class	□

Wiring diagram

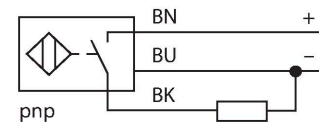

Functional principle

The inductive sensors for the food industry are absolutely tight and resistant to cleaning agents and disinfectants, thanks to the LCP front cap and the stainless steel housing.

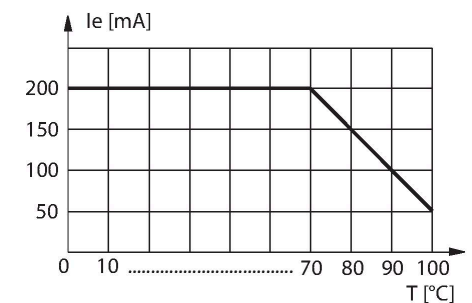

Technical data

Switching frequency	0.75 kHz
Mechanical data	
Design	Threaded barrel, M30 × 1.5
Dimensions	66 mm
Housing material	Stainless steel, 1.4404 (AISI 316L)
Active area material	Plastic, LCP
End cap	Plastic, PP, transparent
Admissible pressure on front cap	≤ 10 bar
Max. tightening torque of housing nut	75 Nm
Electrical connection	Cable
Cable quality	Ø 5.2 mm, White, D12YSL9Y-OB, PP, 7 m halogen-free
Core cross-section	3 x 0.34 mm ²
Environmental conditions	
Ambient temperature	-40...+100 °C
Vibration resistance	55 Hz (1 mm)
Shock resistance	30 g (11 ms)
Protection class	IP68 IP69K
MTTF	874 years acc. to SN 29500 (Ed. 99) 40 °C
Switching state	LED, Yellow

Mounting instructions

Mounting instructions/Description

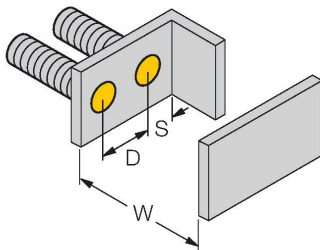
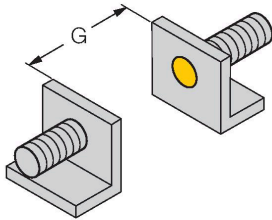
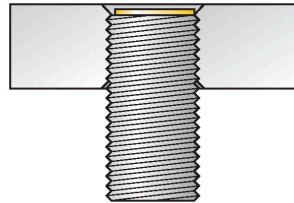

Distance D 60 mm

Distance W 3 x Sn

Distance T 3 x B

Distance S 1.5 x B

Distance G 6 x Sn

Diameter active Ø 30 mm
area B

All flush mountable uprox+ threaded barrel types are also recessed mountable. Safe operation is ensured if the sensor is screwed in by half a turn.

Accessories

MW-30

6945005

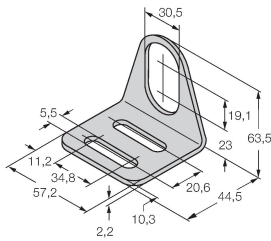

Mounting bracket for threaded barrel sensors; material: Stainless steel A2 1.4301 (AISI 304)

BSS-30

6901319

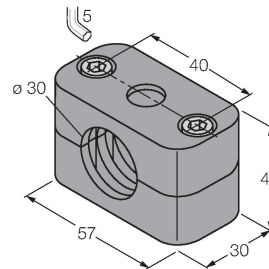

Mounting clamp for smooth and threaded barrel sensors; material: Polypropylene

PN-M30

6905308

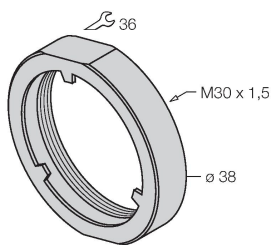

Protective nut for M30 x 1 threaded barrel devices; material: Stainless steel A2 1.4305 (AISI 303)