

BI10-M30-AP6X-H1141

Inductive Sensor

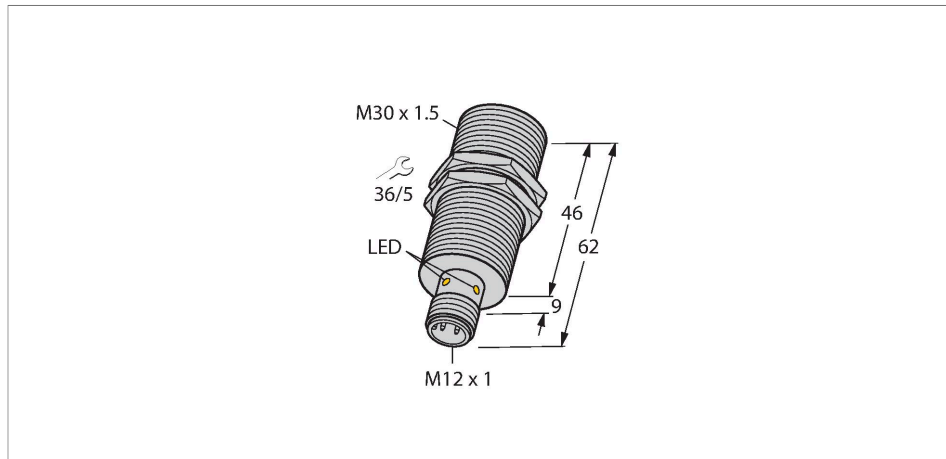

Features

- M30 × 1.5 threaded tube
- Chrome-plated brass
- DC 3-wire, 10...30 VDC
- NO contact, PNP output
- M12 x 1 male connector

Wiring diagram

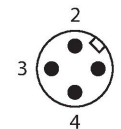
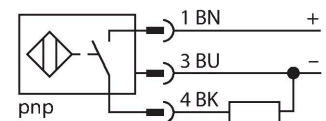

Technical data

| | |
|---|---|
| Type | BI10-M30-AP6X-H1141 |
| ID | 46175 |
| General data | |
| Rated switching distance | 10 mm |
| Mounting conditions | Flush |
| Secured operating distance | $\leq (0.81 \times S_n)$ mm |
| Correction factors | St37 = 1; Al = 0.3; stainless steel = 0.7; Ms = 0.4 |
| Repeat accuracy | ≤ 2 % of full scale |
| Temperature drift | $\leq \pm 10$ % |
| Hysteresis | 3...15 % |
| Electrical data | |
| Operating voltage | 10...30 VDC |
| Residual ripple | ≤ 10 % U_{ss} |
| DC rated operational current | ≤ 200 mA |
| No-load current | 15 mA |
| Residual current | ≤ 0.1 mA |
| Isolation test voltage | ≤ 0.5 kV |
| Short-circuit protection | yes / Cyclic |
| Voltage drop at I_o | ≤ 1.8 V |
| Wire breakage/Reverse polarity protection | yes / Complete |
| Output function | 3-wire, NO contact, PNP |
| Insulation class | □ |
| Switching frequency | 0.5 kHz |

Functional principle

Inductive sensors detect metal objects contactless and wear-free. For this, they use a high-frequency electromagnetic AC field that interacts with the target. Inductive sensors generate this field via an RLC circuit with a ferrite coil.

Technical data

| Mechanical data | |
|---------------------------------------|--|
| Design | Threaded barrel, M30 × 1.5 |
| Dimensions | 62 mm |
| Housing material | Metal, CuZn, Chrome-plated |
| Active area material | Plastic, PA12-GF30 |
| Max. tightening torque of housing nut | 75 Nm |
| Electrical connection | Connector, M12 × 1 |
| Environmental conditions | |
| Ambient temperature | -25...+70 °C |
| Vibration resistance | 55 Hz (1 mm) |
| Shock resistance | 30 g (11 ms) |
| Protection class | IP67 |
| MTTF | 2283 years acc. to SN 29500 (Ed. 99) 40 °C |
| Switching state | LED, Yellow |

Mounting instructions

Mounting instructions/Description



| | |
|------------------------|---------|
| Distance D | 2 x B |
| Distance W | 3 x Sn |
| Distance T | 3 x B |
| Distance S | 1.5 x B |
| Distance G | 6 x Sn |
| Diameter active area B | Ø 30 mm |

Accessories

BST-30B

6947216

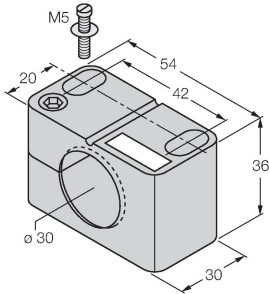

Mounting clamp for threaded barrel sensors, with dead-stop; material: PA6

QM-30

6945103

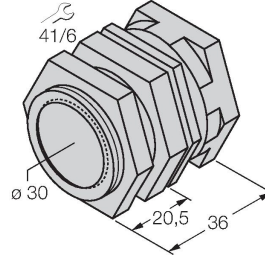

Quick-mount bracket with dead-stop; material: Chrome-plated brass. Male thread M36 × 1.5. Note: The switching distance of the proximity switches may change when using quick-mount brackets.

MW-30

6945005

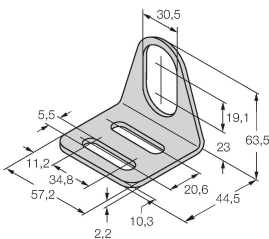

Mounting bracket for threaded barrel sensors; material: Stainless steel A2 1.4301 (AISI 304)

BSS-30

6901319

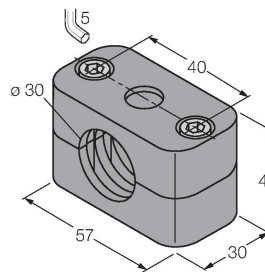

Mounting clamp for smooth and threaded barrel sensors; material: Polypropylene

Wiring accessories

Dimension drawing

Type

ID

RKC4T-2/TEL

6625010

Connection cable, female M12, straight, 3-pin, cable length: 2 m, sheath material: PVC, black; cULus approval; other cable lengths and qualities available, see www.turck.com

