

BI10-P30-AZ3X-B2131/S100

Inductive Sensor – With Increased Temperature Range

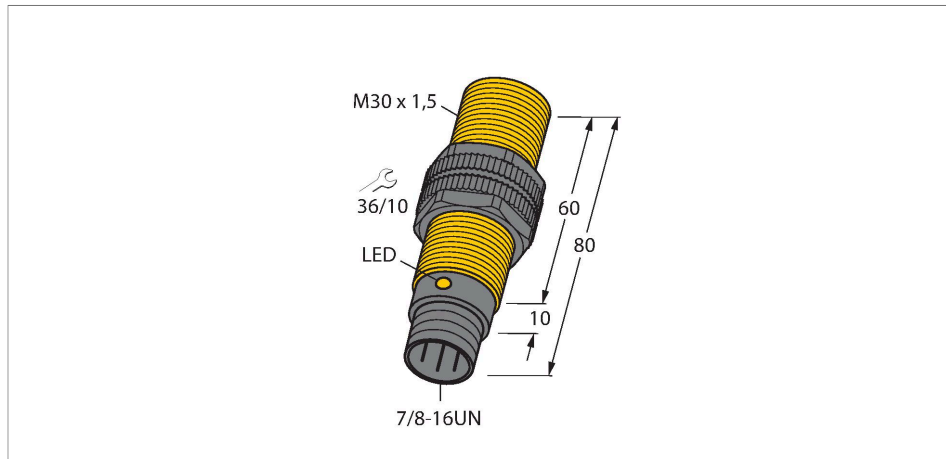

Features

- Threaded barrel, M30 x 1.5
- Plastic, PA12-GF30
- Temperatures up to +100 °C
- AC 2-wire, 20...250 VAC
- DC 2-wire, 10...300 VDC
- NO contact
- 7/8" connector

Wiring diagram

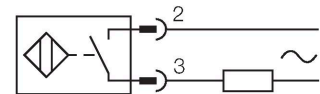

Technical data

Type	BI10-P30-AZ3X-B2131/S100
ID	13526
Special version	S100 corresponds to: Maximum ambient temperature = 100 °C

General data	
Rated switching distance	10 mm
Mounting conditions	Flush
Secured operating distance	$\leq (0.81 \times S_n)$ mm
Correction factors	St37 = 1; Al = 0.3; stainless steel = 0.7; Ms = 0.4
Repeat accuracy	≤ 2 % of full scale
Temperature drift	$\leq \pm 10$ % $\leq \pm 20$ %, $\geq +70$ °C
Hysteresis	3...15 %

Electrical data	
Operating voltage	20...250 VAC
Operating voltage	10...300 VDC
AC rated operational current	≤ 400 mA
DC rated operational current	≤ 300 mA
Rated operational current	See derating curve
Frequency	≥ 50 ... ≤ 60 Hz
Residual current	≤ 1.7 mA
Isolation test voltage	≤ 1.5 kV
Surge current	≤ 8 A (≤ 10 ms max. 5 Hz)
Voltage drop at I_e	≤ 6 V

Functional principle

Inductive sensors detect metal objects contactless and wear-free. For this purpose they use a high-frequency electromagnetic AC field that interacts with the target. The sensors hosting a ferrite core coil generate the AC field through an LC resonant circuit. Special versions are available for ambient temperatures between -60°C and +250°C.

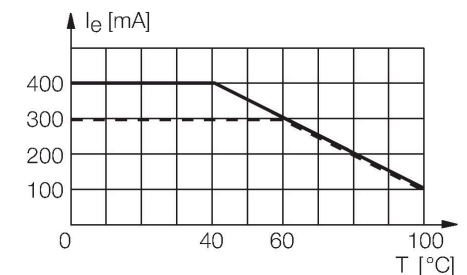

Technical data

Output function	2-wire, NO contact, 2-wire
Smallest operating current	≥ 3 mA
Switching frequency	0.02 kHz
Mechanical data	
Design	Threaded barrel, M30 × 1.5
Dimensions	80 mm
Housing material	Plastic, PA12-GF30
Active area material	Plastic, PA12-GF30
Max. tightening torque of housing nut	5 Nm
Electrical connection	Connector, 7/8"
Environmental conditions	
Ambient temperature	-25...+100 °C
Vibration resistance	55 Hz (1 mm)
Shock resistance	30 g (11 ms)
Protection class	IP67
MTTF	2283 years acc. to SN 29500 (Ed. 99) 40 °C
Switching state	LED, Red

Mounting instructions

Mounting instructions/Description

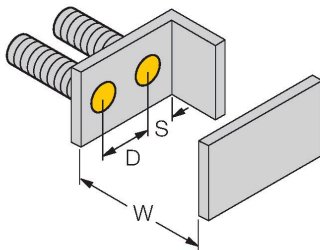
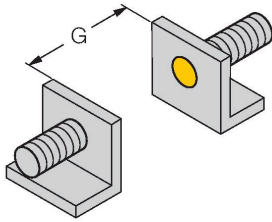
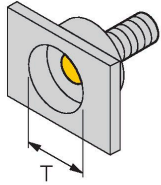

Distance D	2 x B
Distance W	3 x Sn
Distance T	3 x B
Distance S	1.5 x B
Distance G	6 x Sn
Diameter active area B	Ø 30 mm

Accessories

QM-30

6945103

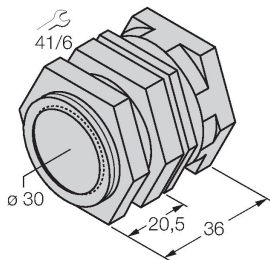

Quick-mount bracket with dead-stop; material: Chrome-plated brass. Male thread M36 × 1.5. Note: The switching distance of the proximity switches may change when using quick-mount brackets.

BST-30B

6947216

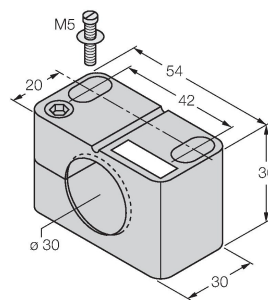

Mounting clamp for threaded barrel sensors, with dead-stop; material: PA6

MW-30

6945005

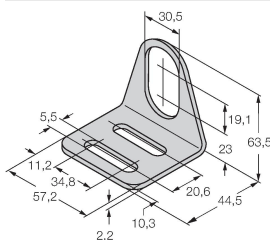

Mounting bracket for threaded barrel sensors; material: Stainless steel A2 1.4301 (AISI 304)

BSS-30

6901319

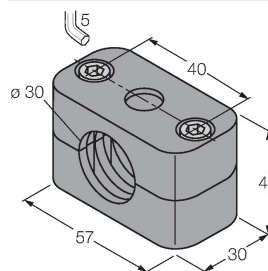

Mounting clamp for smooth and threaded barrel sensors; material: Polypropylene