

Mechanically Jointed Rodless Cylinders

MY3 Series

Basic short type (Rubber bumper)

MY3A Series



Bore sizes
 ø20, ø32, ø50 added

Basic standard type (Air cushion)

MY3B Series



Bore sizes
 ø20, ø32, ø50 added

Slide bearing guide type (Air cushion)

MY3M Series

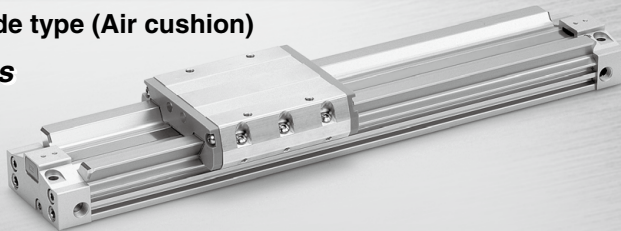

- MY1B
- MY1H
- MY1B
- MY1M
- MY1C
- MY1H
- MY1 HT
- MY1 □W
- MY2C
- MY2 H/HT
- MY3A
- MY3B
- MY3M

Series Variations

★ are new additions

Series	Type	Piping type	Bore size (mm)						Rubber bumper	Air cushion	Stroke adjustment unit Shock absorber	Side support	Floating bracket	Made to Order	Page
			16	20	25	32	40	50							
MY3A	Basic short type	Centralized piping	●	★	●	★	●	★	●	●	●	●	●	Long stroke -XB11 Shock Absorber Soft Type -XB22 Helical Insert Threads -X168	P.1413
MY3B	Basic standard type		●	★	●	★	●	★	●	●	●	●	●		
MY3M	Slide bearing guide type	Standard piping	●	●	●	●	●	●	●	●	●	●	●	Holder Mounting Bracket -X416, -X417 Copper Free 20-	P.1437

Note) Except the MY3A

Shock Absorber Soft Type RJ Series Installed Cylinder (-XB22 spec.) added

- Soft stopping enabled at stroke end.
- Two types of shock absorbers are selectable according to operating environment.

- D-□
- X□
- Technical Data

High functionality with reduced height and length

Mechanically Jointed Rodless Cylinders

MY3 Series

MY3A

Basic short type
(Rubber bumper)



MY3B

Basic standard type
(Air cushion)



MY3M

Slide bearing guide type
(Air cushion)

Work pieces can be loaded directly on the work table due to the integrated guide.

Overall length (Z) reduced by **140 mm** at the maximum

MY3A (with rubber bumper)



MY3B/MY3M (with air cushion)

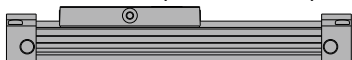

MY1B/MY1M (with air cushion)

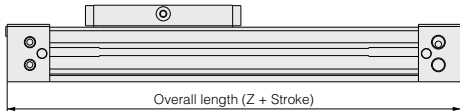

Overall Length (Z)

Series	ø16	ø20	ø25	ø32	ø40	ø50	ø63
MY3A	110	128	150	193	240	274	320
MY3B	122	148	178	225	276	310	356
MY3M	122	—	178	—	276	—	356
MY1B	160	200	220	280	340	400	460
MY1M	—	—	—	—	—	—	—

Loading Capacity

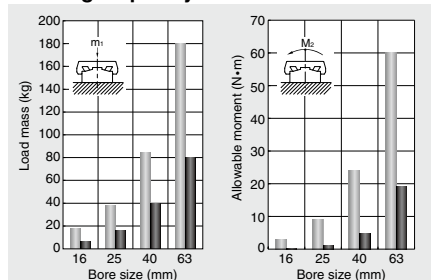

Height (H) reduced by **36%** at the maximum

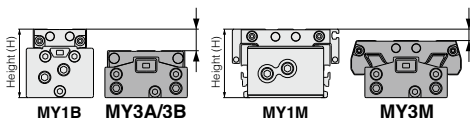

Height (H)

Series	ø16	ø20	ø25	ø32	ø40	ø50	ø63
MY3A	27	32	37	45	54	67	84
MY3B	27	32	37	45	54	67	84
MY1B	37	46	54	68	84	94	116
MY3M	33	—	45	—	63	—	93
MY1M	40	—	54	—	84	—	130

Weight reduced by **55%** at the maximum

Weight

Series	ø16	ø20	ø25	ø32	ø40	ø50	ø63
MY3A	0.33	0.57	0.84	1.61	2.81	4.52	7.58
MY3B	0.34	0.67	0.93	1.75	2.81	4.90	8.16
MY1B	0.73	1.26	1.57	3.01	4.41	8.66	14.5
MY3M	0.45	—	1.20	—	3.65	—	9.99
MY1M	0.91	—	2.12	—	7.00	—	18.8

* At 100 mm stroke

Floating Bracket

Easy connection with external guide. Vertical and lateral mounting is possible. (Page 1435)



(MY3A/3B)

Stroke Adjustment Unit

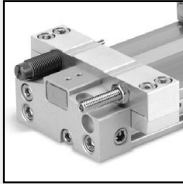

(MY3B/3M)

Side Support

The cylinder tube can be fixed from the upper or lower side. (Page 1434, 1450)

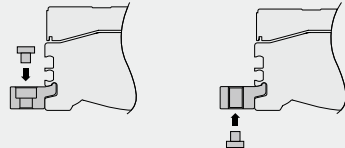
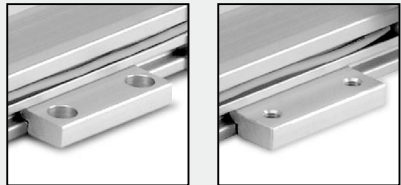

Auto Switch

Can be mounted on both sides from the front direction.

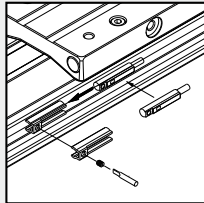

Centralized Piping

Integrated piping in the head cover is possible. (Page 1431, 1432, 1448)

The uniquely designed piston shape enables reduction of the height and length as well as practical arrangement of the common piping passages, cushion mechanism and positioning mechanism. This has achieved drastic miniaturization and weight reduction.

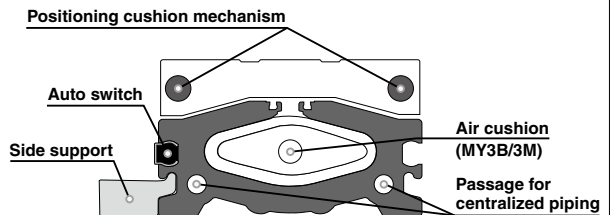

MY1B

MY1H

MY1B

MY1M

MY1C

MY1H

MY1 HT

MY1
□W

MY2C

MY2 H/HT

MY3A

MY3B

MY3M

D-□

-X□

Technical
Data

MY3 Series Model Selection

The following are steps for selecting the MY3 series which is best suited to your application.

Guideline for Tentative Model Selection

Series	Type	Guideline for tentative model selection				Note
		Stroke accuracy	Use of external guide	Direct loaded	Table accuracy	
MY3A	Basic short type	△	◎	△	△	Generally combined with a separate guide making it, by length, more compact.
MY3B	Basic standard type	◎	◎	○	△	Generally combined with a separate guide, when stroke accuracy is required.
MY3M	Slide bearing guide type	◎	×	◎	○	Mounting a work piece directly on the product, when stroke accuracy is required.

◎ Most suitable ○ Suitable △ Usable × Not recommended

Note 1) The table accuracy means the amount of table deflection when a moment is applied.

Note 2) Travelling parallelism is not guaranteed for this cylinder. Please consult with SMC if the travelling parallelism or stroke intermediate position needs to be precise.

Selection Flow Chart

When an external guide is used, the selection confirmation of the guide capacity should follow the selection procedure of the external guide.

The MY3 series allow direct load application within the allowable range for the built-in guide. The payload in this case will vary depending on the driving speed and the mounting orientation of the cylinder. Please refer to the flow below and confirm the selection. (For more detailed description of the selection flow, please refer to the operation manual.)

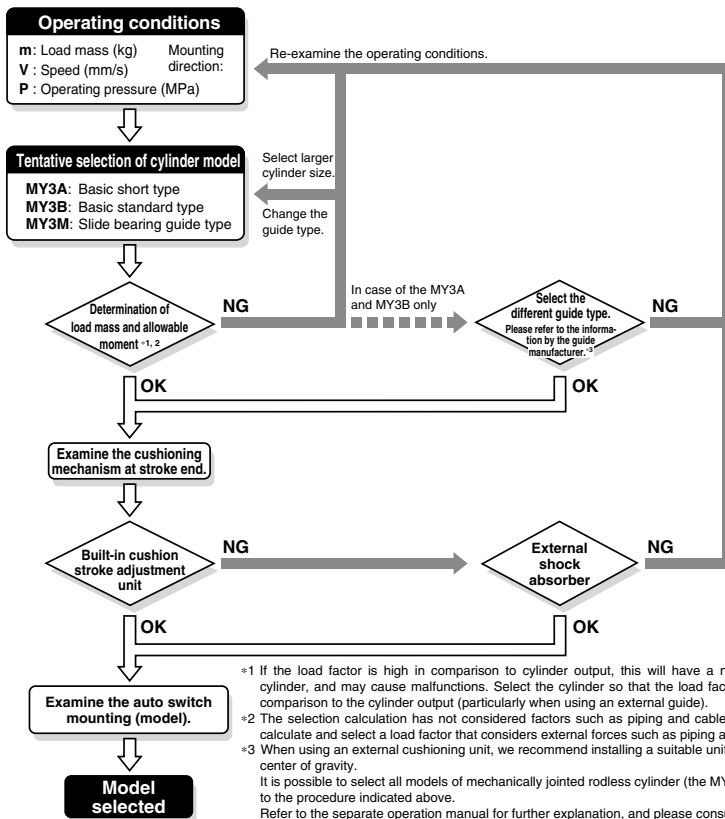

*1 If the load factor is high in comparison to cylinder output, this will have a negative affect on the cylinder, and may cause malfunctions. Select the cylinder so that the load factor is less than 0.5 in comparison to the cylinder output (particularly when using an external guide).

*2 The selection calculation has not considered factors such as piping and cable bearings etc. Please calculate and select a load factor that considers external forces such as piping and cable bearing.

*3 When using an external cushioning unit, we recommend installing a suitable unit near the load's center of gravity.

It is possible to select all models of mechanically jointed rodless cylinder (the MY3 series) according to the procedure indicated above.

Refer to the separate operation manual for further explanation, and please consult with SMC regarding any questions.





Warning

Reduction circuits or shock absorbers may be necessary.

If the driven object is fast, or the weight is large, the cylinder cushion alone may not be able to absorb the impact. In this case, install a reduction circuit before the cushion, or install an external shock absorber to reduce the impact. Please check the machine's rigidity as well.

Maximum operating speed

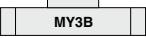
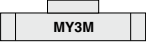
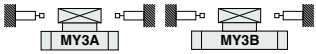
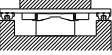
* External shock absorbers must meet the characteristics listed on page 1423. Cylinders may be damaged if shock absorbers that do not have the recommended characteristics are used.

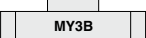
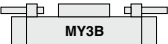
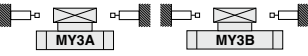
How to mount a load	Stroke positioning	Shock absorber	Maximum operating speed (mm/s)		
			500	1000	1500
Direct loaded 	Cylinder stroke end	Rubber bumper 			
		Air cushion 			
	Stroke adjustment unit (Option: L, H unit)	Shock absorber 			
		External stopper 			
Use of external guide Note 1) 	Cylinder stroke end	Rubber bumper 			
		Air cushion 			
	Stroke adjustment unit (Option: L, H unit)	Shock absorber 	Note 4) Note 5)		
		External stopper 			

Note 1) Mechanically jointed rodless cylinders can be used with a direct load within the allowable range for each guide type, however, careful alignment is necessary for connection to a load which has an external guide mechanism. The mounting bracket for the external guide and the floating bracket must be mounted in a position that guarantees freedom of movement to the floating Y and Z axial. Ensure that the floating bracket is set so that the thrust transmission section has even contact.
* For details on the floating Y and Z axial, refer to the coordinates and moments in the selection method on page 1435.

Note 2) The shock absorber must meet the conditions mentioned on pages 1422 and 1423.

Note 3) As the external shock absorber, a unit with appropriate capacity and features should be installed close to the load center of gravity.

Note 4) Use the stroke adjustment unit of the MY3B series with an external guide.

Note 5) Shown below are the details of the maximum operating speed for the stroke adjustment unit.

MY3 Series, Maximum Operating Speed when Using the Stroke Adjustment Unit

Unit: mm/s

Series	Bore size (mm)	Stroke adjustment range	Inside the fine stroke adjustment range	Outside the fine stroke adjustment range
MY3B	16, 20	L unit	800	500
		H unit	1000	800
MY3M	16, 25, 40, 63	L, H unit	1000	800
		L, H unit	1500	800

Outside the fine stroke adjustment range means that when an intermediate fixing spacer (short spacer, long spacer) is used.
Intermediate fixing spacer → Refer to pages 1425 and 1445.

- MY1B
- MY1H
- MY1B
- MY1M
- MY1C
- MY1H
- MY1 HT
- MY1 □W
- MY2C
- MY2 H/HT
- MY3A
- MY3B
- MY3M

- D-□
- X□

Technical Data

Types of Moment and Load Mass Applied to Rodless Cylinders

Multiple moments may be generated depending on the mounting orientation, load and position of the center of gravity.

Coordinates and Moments

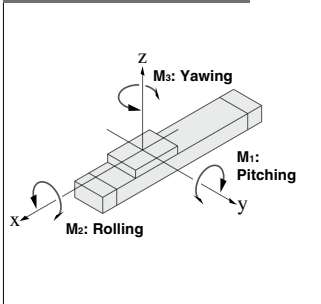

Load Mass and Static Moment

Mounting direction	Horizontal	Ceiling	Wall	Vertical
Static load	m_1	m_2	m_3	m_4 (Note)
Static moment	M_1	$m_1 \times g \times X$	$m_2 \times g \times X$	$m_3 \times g \times Z$
	M_2	$m_1 \times g \times Y$	$m_2 \times g \times Y$	$m_3 \times g \times X$
	M_3	—	$m_3 \times g \times X$	$m_3 \times g \times Y$

Note) m_4 is a mass movable by thrust. Use 0.3 to 0.7 times the thrust (differs depending on the operating speed) as a guide for actual use.

g: Gravitational acceleration

Dynamic Moment

Mounting direction	Horizontal	Ceiling	Wall	Vertical
Dynamic load	F_E	$1.4U_a \times \delta \times m_n \times g$		
Dynamic moment	M_{1E}	$\frac{1}{3} \times F_E \times Z$		
	M_{2E}	Dynamic moment M_{2E} will not be generated.		
	M_{3E}	$\frac{1}{3} \times F_E \times Y$		

Note) Regardless of the mounting orientation, dynamic moment is calculated with the formulae above.

g: Gravitational acceleration
Ua: Average speed
δ: Bumper coefficient

Calculation of Guide Load Factor

1. Maximum load mass (1), static moment (2), and dynamic moment (3) (at the time of impact with stopper) must be examined for the selection calculations.

* To evaluate, use U_a (average speed) for (1) and (2), and U (impact speed $U = 1.4U_a$) for (3). Calculate m_{max} for (1) from the maximum allowable load graph (m_1, m_2, m_3) and M_{max} for (2) and (3) from the maximum allowable moment graph (M_1, M_2, M_3).

$$\text{Sum of guide load factors } \Sigma \alpha = \frac{\text{Load mass [m]}}{\text{Maximum load mass [m}_{max}\text{]}} + \frac{\text{Static moment [M]}}{\text{Allowable static moment [M}_{max}\text{]}} + \frac{\text{Dynamic moment [M}_E\text{]}}{\text{Allowable dynamic moment [M}_{E\text{max}}\text{]}} \leq 1$$

Note 1) Moment caused by the load, etc., with cylinder in resting condition.

Note 2) Moment caused by the impact load equivalent at the stroke end (at the time of impact with stopper).

Note 3) Depending on the shape of the workpiece, multiple moments may occur. When this happens, the sum of the load factors ($\Sigma \alpha$) is the total of all such moments.

2. Reference formulas [Dynamic moment at impact]

Use the following formulas to calculate dynamic moment when taking stopper impact into consideration.

m : Load mass (kg)

F : Load (N)

F_E : Load equivalent to impact (at impact with stopper) (N)

U_a : Average speed (mm/s)

M : Static moment (N·m)

$$U = 1.4U_a \text{ (mm/s)} \quad F_E = 1.4U_a \times \delta \times m \cdot g$$

$$\therefore M_E = \frac{1}{3} \cdot F_E \cdot L_1 = 4.57U_a \delta m L_1 \text{ (N} \cdot \text{m)}$$

Note 4) $1.4U_a \delta$ is a dimensionless coefficient for calculating impact force.

Note 5) Average load coefficient = $\left(\frac{1}{3}\right)$:

This coefficient is for averaging the maximum load moment at the time of stopper impact according to service life calculations.

3. For detailed selection procedure, please refer to pages 1414, 1415, 1438, 1439.

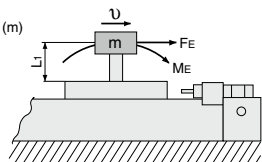

Calculation of Guide Load Factor

1 Operating Conditions

- Cylinder MY3A25-500
- Average operating speed v_a 300 mm/s
- Mounting direction Horizontal mounting
- Cushion Rubber bumper ($\delta = 4/100$)

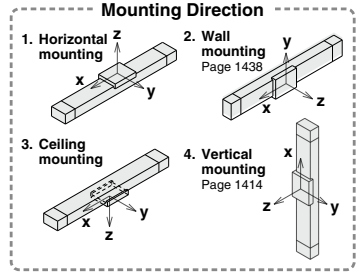
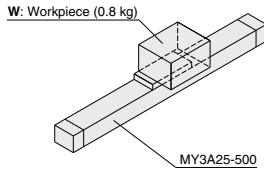

Refer to the pages mentioned above for actual examples of calculation for each orientation.
* For ceiling mounting, refer to 1280.

2 Load Blocking

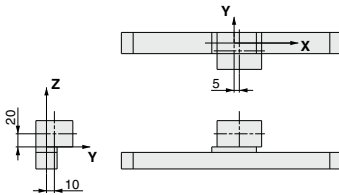

Workpiece Mass and Center of Gravity

Workpiece no.	Mass (m)	Center of gravity		
		X-axis	Y-axis	Z-axis
W	0.8 kg	5 mm	10 mm	20 mm

3 Calculation of Load Factor for Static Load

m₁: Mass

m₁ max (from ① of graph MY3A / **m₁**) = 10.7 (kg)

Load factor $\alpha_1 = m_1 / m_1 \text{ max} = 0.8 / 10.7 = 0.08$

M₁: Moment

M₁ max (from ② of graph MY3A / **M₁**) = 4 (N·m)

M₁ = **m₁** x **g** x **X** = 0.8 x 9.8 x 5 x 10⁻³ = 0.04 (N·m)

Load factor $\alpha_2 = M_1 / M_1 \text{ max} = 0.04 / 4 = 0.01$

M₂: Moment

M₂ max (from ③ of graph MY3A / **M₂**) = 0.8 (N·m)

M₂ = **m₁** x **g** x **Y** = 0.8 x 9.8 x 10 x 10⁻³ = 0.08 (N·m)

Load factor $\alpha_3 = M_2 / M_2 \text{ max} = 0.08 / 0.8 = 0.1$

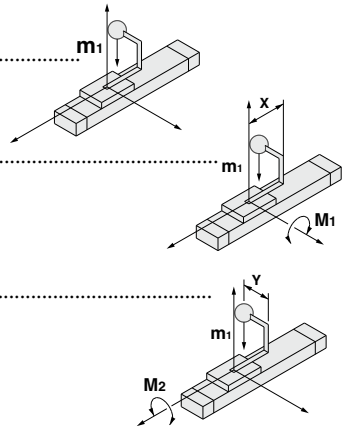

- MY1B
- MY1H
- MY1B
- MY1M
- MY1C
- MY1H
- MY1 HT
- MY1 □W
- MY2C
- MY2 H/HT
- MY3A
- MY3B
- MY3M

- D-□
- X□
- Technical Data

Calculation of Guide Load Factor

4 Calculation of Load Factor for Dynamic Moment

Equivalent load F_E at impact

$$F_E = 1.4U_a \times \delta \times m \times g = 1.4 \times 300 \times \frac{4}{100} \times 0.8 \times 9.8 = 131.7 \text{ (N)}$$

M_{1E} : Moment

$M_{1E} \text{ max}$ (from ④ of graph MY3A / M_1 where $1.4U_a = 420 \text{ mm/s}$) = 2.85 (N·m)

$$M_{1E} = \frac{1}{3} \times F_E \times Z = \frac{1}{3} \times 131.7 \times 20 \times 10^{-3} = 0.88 \text{ (N·m)}$$

$$\text{Load factor } \alpha_4 = M_{1E} / M_{1E} \text{ max} = 0.88 / 2.85 = 0.31$$

M_{3E} : Moment

$M_{3E} \text{ max}$ (from ⑤ of graph MY3A / M_3 where $1.4U_a = 420 \text{ mm/s}$) = 0.95 (N·m)

$$M_{3E} = \frac{1}{3} \times F_E \times Y = \frac{1}{3} \times 131.7 \times 10 \times 10^{-3} = 0.44 \text{ (N·m)}$$

$$\text{Load factor } \alpha_5 = M_{3E} / M_{3E} \text{ max} = 0.44 / 0.95 = 0.43$$

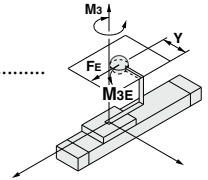
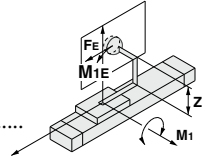

5 Sum and Examination of Guide Load Factors

$$\Sigma\alpha = \alpha_1 + \alpha_2 + \alpha_3 + \alpha_4 + \alpha_5 = 0.08 + 0.01 + 0.1 + 0.31 + 0.43 = 0.93 \leq 1$$

The above calculation is within the allowable value, and therefore the selected model can be used.

Select a shock absorber separately.

In an actual calculation, when the sum of guide load factors $\Sigma\alpha$ in the formula above is more than 1, consider decreasing the speed, increasing the bore size, or changing the product series.

Load Mass

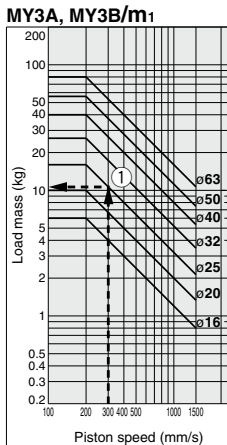

Allowable Moment

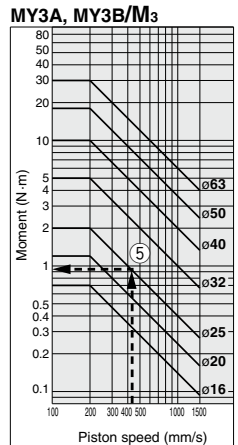
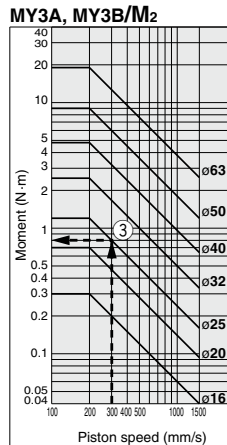
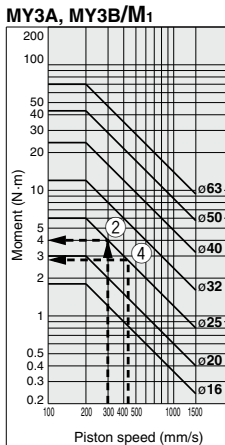

* Refer to page 1439 for the MY3M.

Mounting of Fitting and Speed Controller

When the stroke adjustment unit is used with MY3B and MY3M, the fittings mountable on the front or back port will be limited to those listed below.

In such cases, since **direct mount type speed controllers cannot be mounted**, use in-line type speed controllers. (Except MY3B40/50/63 and MY3M63)

Mounting (Mounting a male connector)

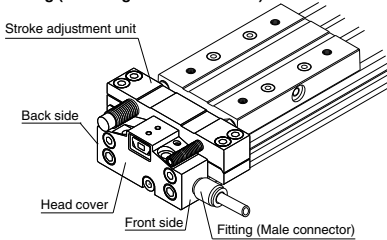

Refer to Best Pneumatics No. 7 for the details of fittings and speed controllers.

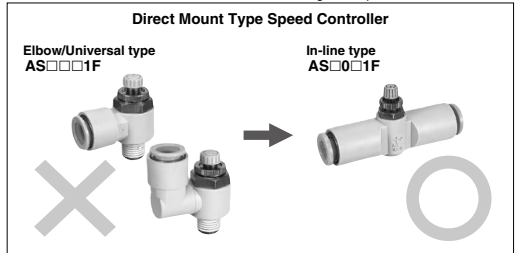

Cylinder model size	Connection thread	Applicable tubing O.D. (mm)	Fitting type	Fitting model
MY3□16	M5	3.2	Male connector	KQ2H23-M5□
			Male elbow	KQ2L23-M5□
			Hexagon socket head male connector	KQ2S23-M5□
		4	Male connector	KQ2H23-M5
			Male elbow	KQ2L23-M5
			Hexagon socket head male connector	KQ2S04-M5
	M5	4	Male connector	KQ2L04-M5□
			Male elbow	KQ2L04-M5
			Hexagon socket head male connector	KQ2S04-M5
		6	Male connector	KQ2S04-M5
			Male elbow	KQ2L06-M5
			Hexagon socket head male connector	KQ2S23-M5□
MY3□20	M5	3.2	Male connector	KQ2H23-M5□
			Male elbow	KQ2L23-M5
			Hexagon socket head male connector	KQ2S04-M5
		4	Male connector	KQ2H04-M5
			Male elbow	KQ2L04-M5
			Hexagon socket head male connector	KQ2S04-M5
	M5	6	Male connector	KQ2H06-M5
			Male elbow	KQ2L06-M5
			Hexagon socket head male connector	KQ2S06-M5
		3.2	Male connector	KQ2H23-01S
			Male elbow	KQ2L23-01S
			Hexagon socket head male connector	KQ2S23-01S
MY3□25	Rc1/8	4	Male connector	KQ2H04-01□S
			Male elbow	KQ2L04-01S
			Hexagon socket head male connector	KQ2S04-01□S
		6	Male connector	KQ2H04-01S
			Male elbow	KQ2L04-01S
			Hexagon socket head male connector	KQ2S04-01S
	Rc1/8	4	Male connector	KQ2H06-01□S
			Male elbow	KQ2L06-01S
			Hexagon socket head male connector	KQ2S06-01□S
		6	Male connector	KQ2H06-01S
			Male elbow	KQ2L06-01S
			Hexagon socket head male connector	KQ2S06-01S
MY3□32	Rc1/8	4	Male connector	KQ2H04-01S
			Male elbow	KQ2L04-01S
			Hexagon socket head male connector	KQ2S04-01S
		6	Male connector	KQ2H06-01S
			Male elbow	KQ2L06-01S
			Hexagon socket head male connector	KQ2S06-01S
	Rc1/8	8	Male connector	KQ2H08-01S
			Male elbow	KQ2L08-01S
			Hexagon socket head male connector	KQ2S08-01S

Cylinder model size	Connection thread	Applicable tubing O.D. (mm)	Fitting type	Fitting model
MY3□40	Rc1/4	4	Male connector	KQ2H04-02S
			Male connector	KQ2H06-02S
			Male elbow	KQ2L06-02S
		6	Hexagon socket head male connector	KQ2S06-02S
			Male connector	KQ2H08-02S
			Male elbow	KQ2L08-02S
	Rc3/8	8	Hexagon socket head male connector	KQ2S08-02S
			Male connector	KQ2H06-03S
			Male elbow	KQ2L06-03S
		6	Hexagon socket head male connector	KQ2S06-03S
			Male connector	KQ2H08-03S
			Male elbow	KQ2L08-03S
MY3□50	Rc3/8	8	Hexagon socket head male connector	KQ2S08-03S
			Male connector	KQ2H10-03S
			Male elbow	KQ2L10-03S
		10	Hexagon socket head male connector	KQ2S10-03S
			Male connector	KQ2H12-03S
			Male elbow	KQ2L12-03S
	Rc3/8	12	Hexagon socket head male connector	KQ2S12-03S
			Male connector	KQ2H10-03S
			Male elbow	KQ2L10-03S
		6	Male connector	KQ2H06-03S
			Male elbow	KQ2L08-03S
			Male connector	KQ2H10-03S
MY3□63	Rc3/8	10	Male elbow	KQ2L10-03S
			Hexagon socket head male connector	KQ2S10-03S
			Male connector	KQ2H12-03S
		12	Male elbow	KQ2L12-03S
			Hexagon socket head male connector	KQ2S12-03S
			Male connector	KQ2H10-03S
	Rc3/8	16	Male elbow	KQ2L16-03S

MY1B

MY1H

MY1B

MY1M

MY1C

MY1H

MY1 HT

MY1 □W

MY2C

MY2 H/HT

MY3A

MY3B

MY3M

D-□

-X□

Technical Data

MY3A Series

**Basic, short type
(Rubber bumper)**

ø16, ø20, ø25, ø32, ø40, ø50, ø63



MY1B

MY1H

MY1B

MY1M

MY1C

MY1H

MY1
HT

MY1
□W

MY2C

MY2
H/HT

MY3A
MY3B

MY3M

MY3B Series

**Basic, standard type
(Air cushion)**

ø16, ø20, ø25, ø32, ø40, ø50, ø63

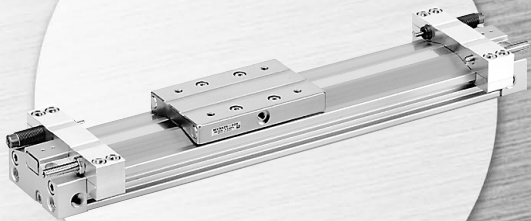

D-□

-X□

Technical
Data

MY3A/3B Series Model Selection

The following are steps for selecting the MY3 series which is best suited to your application.

Calculation of Guide Load Factor

1 Operating Conditions

Cylinder MY3B25-500
 Average operating speed v_a 300 mm/s
 Mounting direction Vertical mounting
 Cushion Shock absorber ($\delta=1/100$)

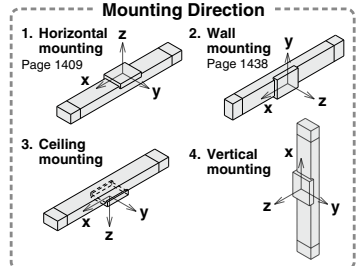
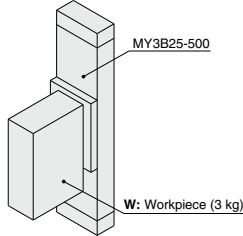

Refer to the pages mentioned above for actual examples of calculation for each orientation.
 * For ceiling mounting, refer to page 1280.

2 Load Blocking

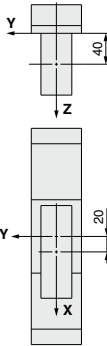

Workpiece Mass and Center of Gravity

Workpiece no.	Mass (m)	Center of gravity		
		X-axis	Y-axis	Z-axis
W	3 kg	20 mm	0 mm	40 mm

3 Calculation of Load Factor for Static Load

m : Mass

m is a mass moveable by thrust. Use 0.3 to 0.7 times the thrust
 (differs depending on the operating speed) as a guide for actual use.

M₁: Moment

M₁ max (from ① of graph MY3A/3B/M₁) = 4 (N·m)

M₁ = m X g x Z = 3 x 9.8 x 40 x 10⁻³ = 1.18 (N·m)

Load factor $\alpha_1 = M_1 / M_2 \text{ max} = 1.18 / 4 = 0.29$

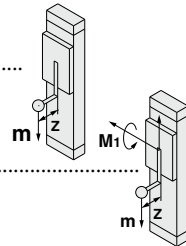

Calculation of Guide Load Factor

4 Calculation of Load Factor for Dynamic Moment

Equivalent load F_E at impact

$$F_E = 1.4Ua \times \delta \times m \times g = 1.4 \times 300 \times \frac{1}{100} \times 3 \times 9.8 = 123.56 \text{ (N)}$$

M_{1E} : Moment

$M_{1E} \text{ max}$ (from ② of graph MY3A/3B/M1 where $1.4Ua = 420 \text{ mm/s}$) = 2.86 (N·m)

$$M_{1E} = \frac{1}{3} \times F_E \times Z = \frac{1}{3} \times 123.56 \times 40 \times 10^{-3} = 1.65 \text{ (N·m)}$$

$$\text{Load factor } \alpha_2 = M_{1E} / M_{1E} \text{ max} = 1.65 / 2.86 = 0.58$$

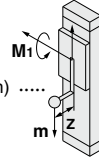

5 Sum and Examination of Guide Load Factors

$$\Sigma \alpha = \alpha_1 + \alpha_2 = 0.87 \leq 1$$

The above calculation is within the allowable value, and therefore the selected model can be used.

Select a shock absorber separately.

In an actual calculation, when the sum of guide load factors $\Sigma \alpha$ in the formula above is more than 1, consider decreasing the speed, increasing the bore size, or changing the product series. Calculating the above formula is easy with the [SMC Pneumatics CAD System].

Allowable Moment

MY3A, MY3B/M1

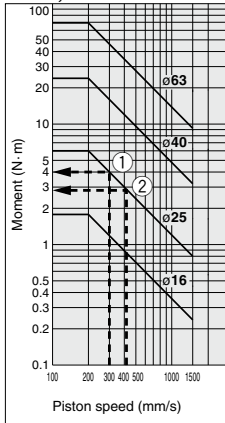

MY1B
MY1H
MY1B
MY1M
MY1C
MY1H
MY1 HT
MY1 □W
MY2C
MY2 H/HT
MY3A
MY3B
MY3M

D-□
-X□
Technical Data

MY3A/3B Series

Maximum Allowable Moment / Maximum Allowable Load

Series	Bore size (mm)	Maximum Allowable Moment (N·m)			Maximum Allowable Load (kg)		
		M ₁	M ₂	M ₃	m ₁	m ₂	m ₃
MY3A MY3B	16	1.8	0.3	0.7	6	3	1.5
	20	3	0.7	1.2	10	4.3	2.4
	25	6	1.2	2	16	6	4
	32	12	2.5	5	26	8.5	6.7
	40	24	4.8	10	40	12	10
	50	43	9	18	56	17	14
63	70	19	30	80	24	20	

The above values are the maximum allowable values for moment and load. Refer to each graph regarding the maximum allowable moment and maximum allowable load for a particular piston speed.

Types of Moment and Load Mass Applied to Rodless Cylinders

Multiple moments may be generated depending on the mounting orientation, load and position of the center of gravity.

Coordinates and Moments

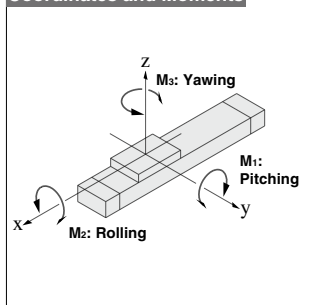

Load Mass and Static Moment

Mounting direction	Horizontal	Ceiling	Wall	Vertical
Static load m	m ₁	m ₂	m ₃	m ₄ ^(Note)
Static moment	M ₁	m ₂ × g × X	—	m ₄ × g × Z
	M ₂	m ₁ × g × Y	m ₂ × g × Y	—
	M ₃	—	—	m ₃ × g × X

Note) M₄ is a mass movable by thrust. Use 0.3 to 0.7 times the thrust (differs depending on the operating speed) as a guide for actual use.

g: Gravitational acceleration

Dynamic Moment

Mounting direction	Horizontal	Ceiling	Wall	Vertical
Dynamic load Fe	1.4U _a × δ × m _n × g			
Dynamic moment	M _{1E}	1/3 × Fe × Z		
	M _{2E}	Dynamic moment M _{2E} will not be generated.		
	M _{3E}	1/3 × Fe × Y		

Note) Regardless of the mounting orientation, dynamic moment is calculated with the formulae above.

g: Gravitational acceleration
U_a: Average speed
δ: Bumper coefficient

Select the moment from within the range of operating limits shown in the graphs. Note that the maximum allowable load value may sometimes be exceeded even within the operating limits shown in the graphs. Therefore, also check the allowable load for the selected conditions.

Maximum Allowable Moment

MY3A, MY3B/m₁

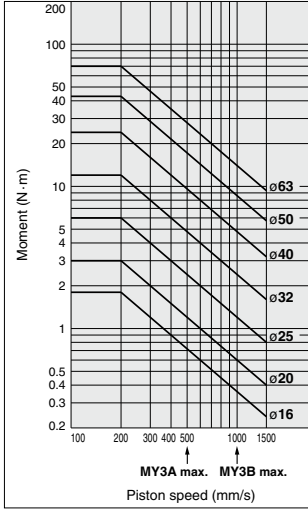

MY3A, MY3B/m₂

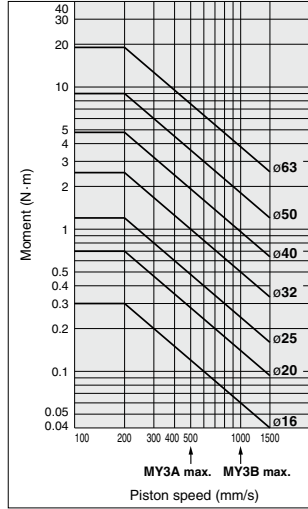

MY3A, MY3B/m₃

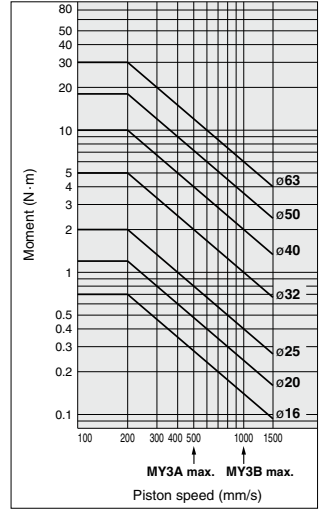

Select the moment from within the range of operating limits shown in the graphs. Note that the maximum allowable load value may sometimes be exceeded even within the operating limits shown in the graphs. Therefore, also check the allowable load for the selected conditions.

Maximum Allowable Load

MY3A, MY3B/m₁

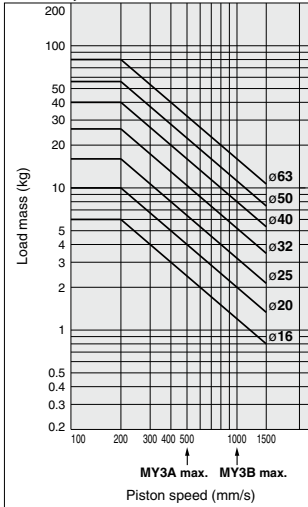

MY3A, MY3B/m₂

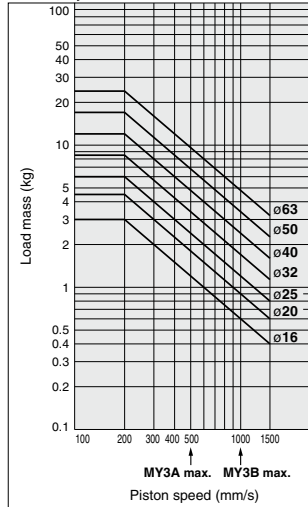

MY3A, MY3B/m₃

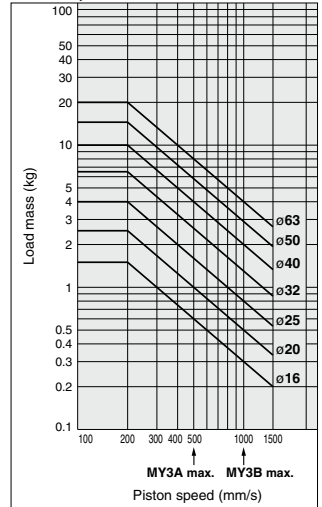

MY1B

MY1H

MY1B

MY1M

MY1C

MY1H

MY1 HT

MY1

□ W

MY2C

MY2 H/HT

MY3A

MY3B

MY3M

D-□

-X□

Technical Data

MY3A/3B Series

Cushion Capacity

Absorption Capacity of Rubber Bumper (MY3A)

MY3A16

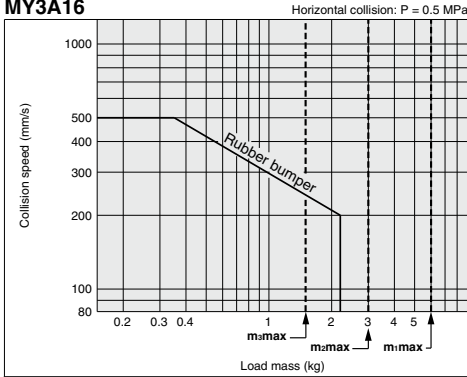

MY3A20

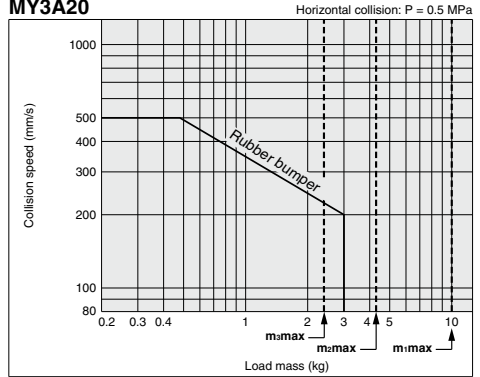

MY3A25

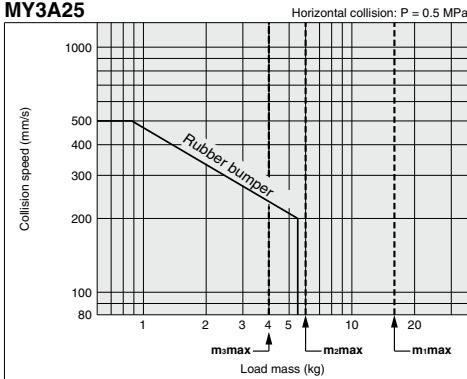

MY3A32

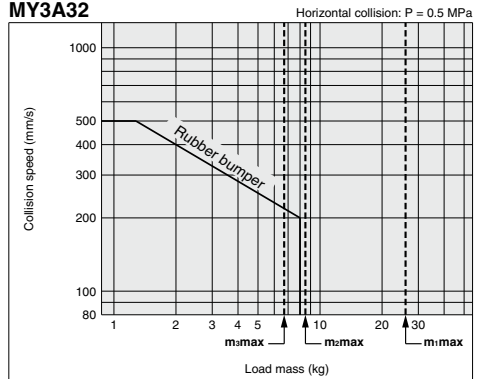

Rubber Bumper Displacement (Additional Stroke due to Pressure on Each Side)

The stop position of the built-in rubber bumper of the MY3A series varies depending on the operating pressure. For alignment at the stroke end, find the guideline for the stroke end position in operation as follows. Find the incremental displacement at the operating pressure in the graph and add it to the stroke end position at no pressurization. If positioning accuracy is required for the stop position at the stroke end, consider installing an external positioning mechanism or switching to the air cushion type (MY3B).

MY3A16

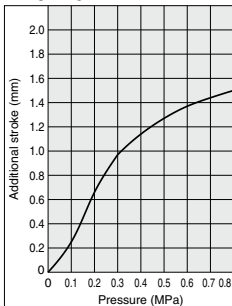

Additional Stroke due to Pressure on Each Side (MY3A16)

MY3A20

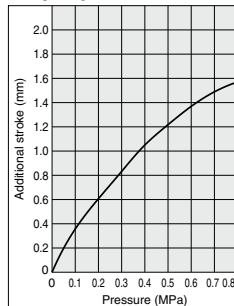

Additional Stroke due to Pressure on Each Side (MY3A20)

MY3A25

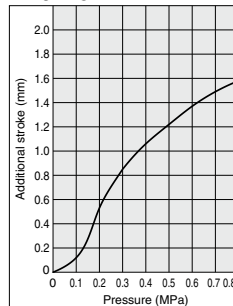

Additional Stroke due to Pressure on Each Side (MY3A25)

MY3A32

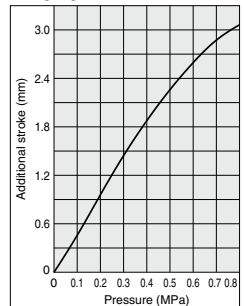

Additional Stroke due to Pressure on Each Side (MY3A32)

MY3A40

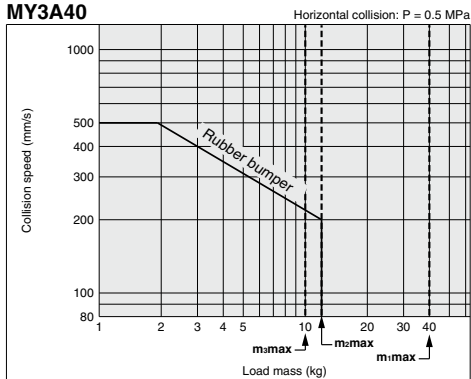

MY3A50

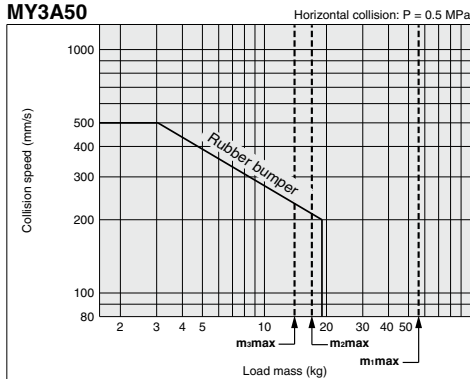

MY3A63

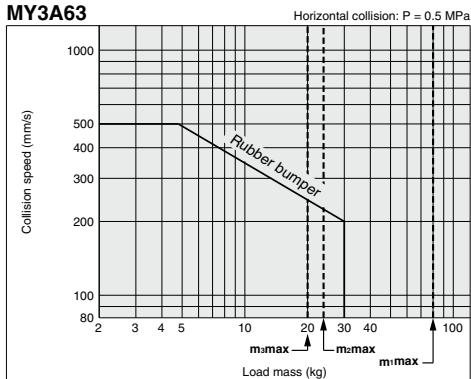

MY1B

MY1H

MY1B

MY1M

MY1C

MY1H

MY1 HT

MY1

□W

MY2C

MY2 H/HT

MY3A

MY3B

MY3M

MY3A40

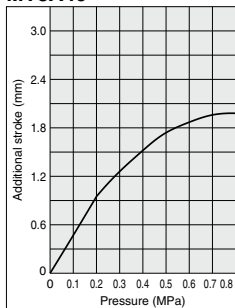

Additional Stroke due to Pressure on Each Side (MY3A40)

MY3A50

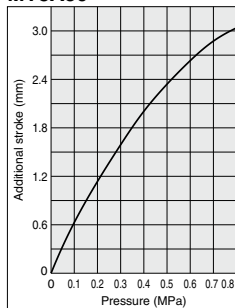

Additional Stroke due to Pressure on Each Side (MY3A50)

MY3A63

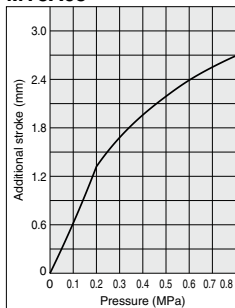

Additional Stroke due to Pressure on Each Side (MY3A63)

D-□

-X□

Technical Data

MY3A/3B Series

Cushion Capacity

Absorption Capacity of Air Cushion and Stroke Adjustment Unit (MY3B)

MY3B16

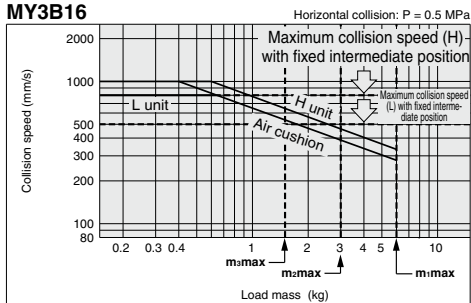

MY3B20

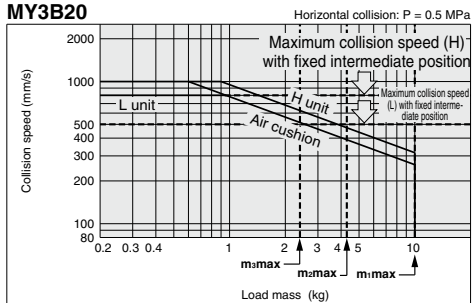

MY3B25

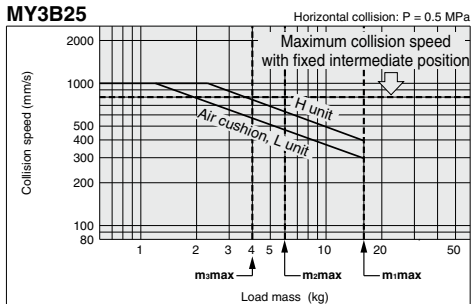

MY3B32

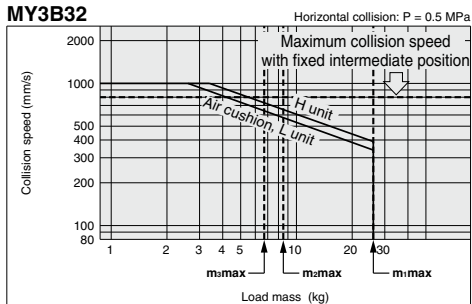

MY3B40

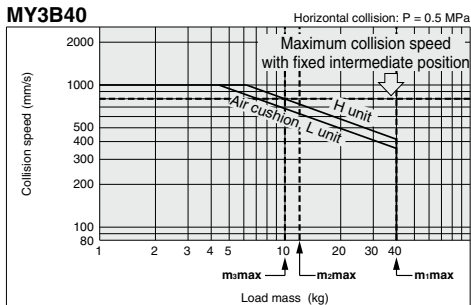

MY3B50

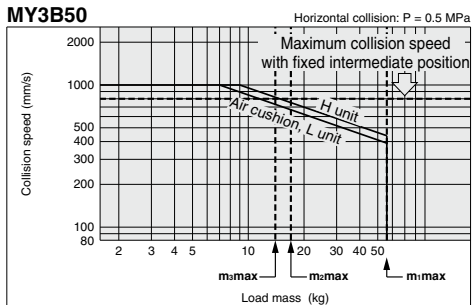

MY3B63

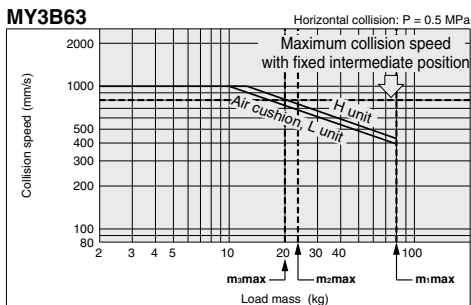

Air Cushion Stroke

Unit: mm

Bore size (mm)	Cushion stroke
16	13
20	16
25	18
32	22
40	25
50	28
63	30

Calculation of Absorbed Energy for Stroke Adjustment Unit with Built-in Shock Absorber Unit: N·m

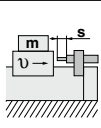
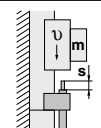
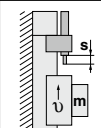
Type of collision	Horizontal	Vertical (downward)	Vertical (upward)
			
Kinetic energy E ₁	$\frac{1}{2} m \cdot v^2$		
Thrust energy E ₂	F·s	F·s + m·g·s	F·s - m·g·s
Absorbed energy E	E ₁ + E ₂		

Stroke Adjustment Unit Fine Stroke Adjustment Range Unit: mm

Bore size (mm)	Fine stroke adjustment range
16, 20	0 to -10
25, 32	0 to -12
40, 50	0 to -16
63	0 to -24

Note) The maximum operating speed will differ when the stroke adjustment unit is used outside the maximum fine stroke adjustment range (with reference to the fixed stroke end), such as at a fixed intermediate position (X416, X417). (Refer to the graph on page 1420.)

Symbols

v : Speed of impacting object (m/s) m : Weight of impacting object (kg)
 F : Cylinder thrust (N) g : Gravitational acceleration (9.8 m/s²)

s : Shock absorber stroke (m)

Note) The speed of the impacting object is measured at the time of collision with the shock absorber.

Note) With an operating pressure of 0.6 MPa or larger, the use of a cushion or an external shock absorber conforming to the conditions on pages 1422 and 1423 is recommended.

Stroke Adjustment

<Stroke adjustment of the adjustment bolt>

Loosen the lock nut for the adjustment bolt, adjust the stroke on the head cover side with a hexagon wrench, and secure with a lock nut.

<Stroke adjustment of the shock absorber: MY3B>

Loosen the two unit fixing bolts on the shock absorber side and rotate the shock absorber for stroke adjustment. Tighten the unit fixing bolts equally to secure the shock absorber. Use caution not to overtighten the fixing bolts.

(Refer to "MY3B Stroke Adjustment Unit Tightening Torque for Fixing Bolts.")

MY3B Stroke Adjustment Unit Tightening Torque for Fixing Bolts Unit: N·m

Bore size (mm)	Unit	Tightening torque
16, 20	L	0.7
	H	
25, 32	L	3.5
	H	
40, 50	L	13.8
	H	
63	L	27.5
	H	

Caution

1. Use caution not to have your hands caught in the unit.

When using a cylinder with stroke adjustment unit, the space between the slide table (slider) and the stroke adjustment unit is very narrow. Care should be taken to avoid the danger of hands being caught in this small space. Install a protective cover to prevent the risk of accidents to the human body.

2. The stroke adjustment unit may interfere with the mounting bolt when mounting the cylinder on the equipment.

Loosen the unit fixing bolt and dislocate the stroke adjustment unit before mounting the cylinder. After fixing the cylinder, move the stroke adjustment unit back to the desired location and tighten the unit fixing bolt.

Use caution not to overtighten the fixing bolts.

(Refer to "MY3B Stroke Adjustment Unit Tightening Torque for Fixing Bolts".)

Caution

3. Use an external guide for the MY3B stroke adjustment unit.

If a stroke adjustment unit is used where a load is directly applied, the collision reaction may cause damage to the cylinder.

4. Conduct stroke adjustment with an adjustment bolt as follows:

The adjustment bolt should be secured on the same surface as the shock absorber after stroke adjustment.

If the stopper surface of the shock absorber and the end surface of the adjustment bolt are not on the same level, it may result in an unstable stop position of the slide table or reduced durability.

5. Securing the unit body

-MY3B>

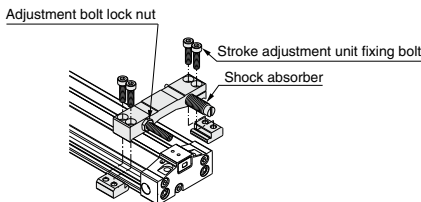

Tighten the four unit fixing bolts equally to secure the unit body.

6. Do not fix and use the stroke adjustment unit at an intermediate position (MY3B).

When the stroke adjustment unit is fixed in an intermediate position, slippage can occur depending on the amount of energy released at the time of an impact. In that case, use a short spacer or a long spacer. For other lengths, please consult with SMC.

(Refer to "MY3B Stroke Adjustment Unit Tightening Torque for Fixing Bolts".)

If the stroke adjustment unit is fixed at an intermediate position, the energy absorption capacity may be different. For this reason, refer to the maximum absorbed energy listed above, and use the adjustment unit within the allowable absorption capacity.

MY1B

MY1H

MY1B

MY1M

MY1C

MY1H

MY1 HT

MY1 □W

MY2C

MY2 H/HT

MY3A

MY3B

MY3M

D-□

-X□

Technical Data

MY3A/3B Series

External Shock Absorber Selection

When the positioning of the stop position is necessary or the absorption capacity of the built-in cushion is not sufficient, refer to the selection procedure below and consider the installation of an external shock absorber.

Selection Confirmation Items with Use of External Shock Absorber

① When the cylinder alone is used.

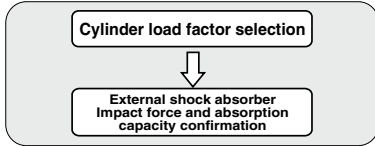

Allowable impact force with use of external shock absorber

MY3□16

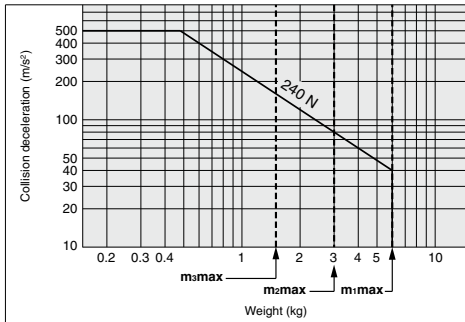

MY3□20

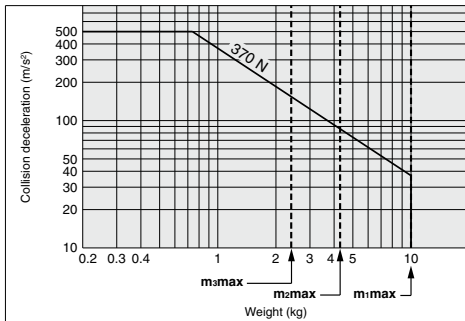

MY3□25

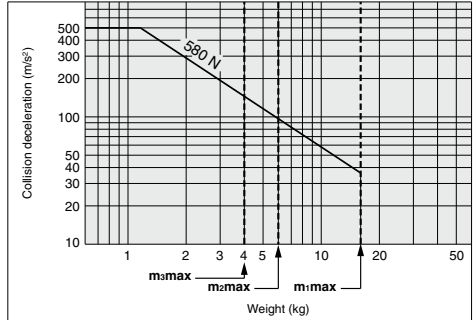

MY3□32

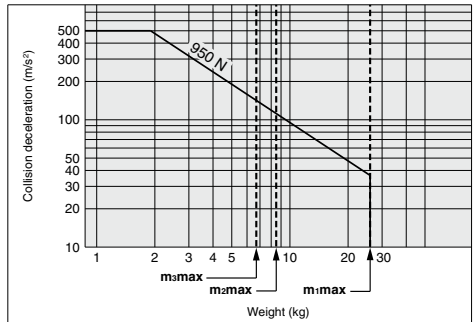

MY3□40

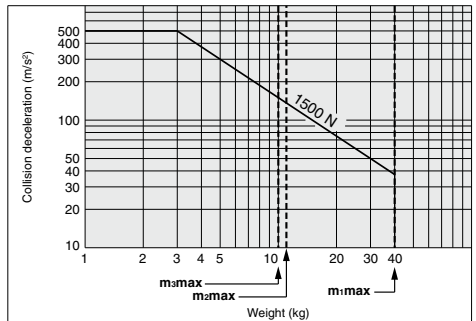

MY3□50

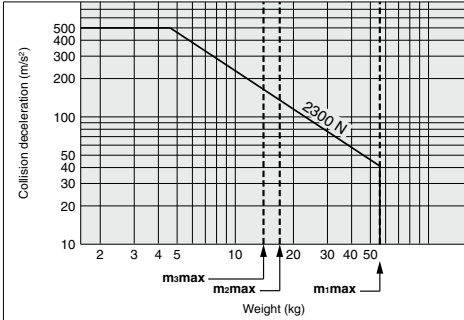

MY3□63

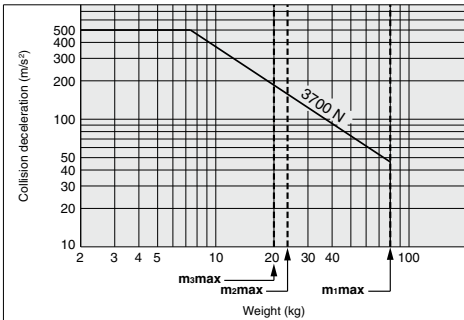

② When the external guide is used.

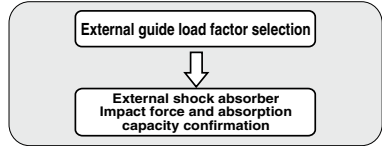

Piston Speed with Use of External Shock Absorber

Bore size (mm)	16	20	25	32	40	50	63
MY3A	80 to 1500 mm/s						
MY3B							

An external shock absorber can be used within the above piston speed range. In conjunction with the absorption capacity selection, however, also confirm the conditions which make the shock absorber collision impact force to stay within the allowable range in the graph.

Use of an external shock absorber with conditions exceeding the allowable range may damage the cylinder.

To confirm the collision impact force of the shock absorber, first find the impact force or acceleration under the operating conditions using the selection information or selection software provided by the manufacturer and then, refer to the graph.

(The selection should allow a sufficient margin because the value calculated by the selection software involves an error with reference to the actual value.)

Example of Recommended Use of the External Shock Absorber

MY3□	$\begin{matrix} 16 \\ 20 \end{matrix}$	⇒	RB-OEM0.25M
MY3□	$\begin{matrix} 25 \\ 32 \end{matrix}$	⇒	RB-OEM0.5M
MY3□	$\begin{matrix} 40 \\ 50 \end{matrix}$	⇒	RB-OEM1.0MF
MY3□	63	⇒	RB-OEM1.5M x 1

MY1B

MY1H

MY1B

MY1M

MY1C

MY1H

MY1 HT

MY1 □W

MY2C

MY2 H/HT

MY3A

MY3B

MY3M

D-□

-X□

Technical
Data

Mechanically Jointed Rodless Cylinder/Basic Type

MY3A/3B Series

ø16, ø20, ø25, ø32, ø40, ø50, ø63

How to Order

Basic MY3 **B** **16** - **300** - **M9BW** -

Type

A	Short type (Rubber bumper)
B	Standard type (Air cushion)

Cylinder bore size

16	16 mm
20	20 mm
25	25 mm
32	32 mm
40	40 mm
50	50 mm
63	63 mm

Port thread type

Symbol	Type	Bore size
NII	M5	ø16, ø20
	Rc	
TN	NPT	ø25, ø32, ø40
TF	G	ø50, ø63

Auto switch

Nil	2 pcs.
S	1 pc.
n	"n" pcs.

Stroke adjustment unit symbol

Nil	Without auto switch (Built-in magnet)
------------	---------------------------------------

Made to Order
Refer to page 1425 for details.

Number of auto switches

Stroke adjustment unit symbol
Refer to "Stroke adjustment unit" on page 1425.
* Stroke adjustment unit is not available for MY3A.

Cylinder stroke (mm)

Bore size (mm)	Standard stroke (mm)*	Maximum manufacturable stroke (mm)
16, 20, 25	100, 200, 300, 400, 500, 600	3000
32, 40, 50	700, 800, 900, 1000, 1200	
63	1400, 1600, 1800, 2000	

* Strokes are manufacturable in 1 mm increments, up to the maximum stroke. However, when the stroke is 49 mm or less, the air cushion capability lowers and multiple auto switches cannot be mounted. Pay special attention to this point.
Also when exceeding a 2000 mm stroke, specify "-XB11" at the end of the model number.
For details, refer to the "Made to Order Specifications".

Applicable Auto Switches

Refer to pages 1575 to 1701 for further information on auto switches.

Type	Special function	Electrical entry	Indicator light	Wiring (Output)	Load voltage		Auto switch model		Lead wire length (m)				Pre-wired connector	Applicable load
					DC	AC	Perpendicular	In-line	0.5 (Nil)	1 (M)	3 (L)	5 (Z)		
Solid state auto switch	—	Grommet	Yes	3-wire (NPN)	5 V, 12 V	—	M9NV	M9N	●	●	●	○	IC circuit	Relay, PLC
				3-wire (PNP)			M9PV	M9P	●	●	●	○		
				2-wire	M9BV		M9B	●	●	●	○	—		
				3-wire (NPN)	M9NWV		M9NW	●	●	●	○	IC circuit		
	Diagnostic indication (2-color indicator)			3-wire (PNP)	M9PWV		M9PW	●	●	●	○	—		
				2-wire	M9BWW		M9BW	●	●	●	○	—		
	Water resistant (2-color indicator)			3-wire (NPN)	M9NAV *1		M9NA *1	○	○	●	○	○	IC circuit	
				3-wire (PNP)	M9PAV *1		M9PA *1	○	○	●	○	○		
		2-wire	M9BAV *1	M9BA *1	○	○	●	○	—					
		—	Grommet	No	3-wire (NPN equiv.)	5 V	—	A96V	A96	●	—	—	—	
2-wire	24 V	12 V			100 V	A93V *2	A93	●	●	●	—	—	Relay, PLC	
					100 V or less	A90V	A90	●	—	—	—	—	IC circuit	

*1 Water resistant type auto switches can be mounted on the above models, but in such case SMC cannot guarantee water resistance.

Consult with SMC regarding water resistant types with the above model numbers.

*2 1 m type lead wire is only applicable to D-A93.

Lead wire length symbols: 0.5 m Nil (Example) M9NV
1 m M (Example) M9NVW
3 m L (Example) M9NVL
5 m Z (Example) M9NVZ

* Solid state auto switches marked with "○" are produced upon receipt of order.

* Separate switch spacers (BM93-016) are required for retrofitting of auto switches.

* There are other applicable auto switches than listed above. For details, refer to page 1451.

* Refer to pages 1648 and 1649 for the details of auto switches with a pre-wired connector.

* Auto switches are shipped together (not assembled). (Refer to page 1451 for the details of auto switch mounting.)

MY3A (Rubber bumper)



MY3B (Air cushion)

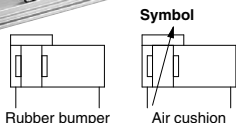
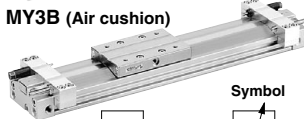

Made to Order: Individual Specifications
(For details, refer to page 1452.)

Symbol	Specifications
-X168	Helical insert thread

Made to Order

[Click here for details](#)

Symbol	Specifications
-XB11	Long stroke type
-XB22	Shock absorber soft type RJ series type

Stroke Adjustment Unit Specifications

Bore size (mm)		16, 20			25, 32			40, 50		63	
Unit symbol		L	H	L	H	L	H	L	H	L	H
Shock absorber model		RB0806	RB1007	RB1007	RB1412	RB1412	RB2015	RB2015	RB2015	RB2725	RB2725
Shock absorber soft type RJ series (-XB22) model		RJ0806H	RJ1007H	RJ1007H	RJ1412H	RJ1412H	—	—	—	—	—
Stroke adjustment range by intermediate fixing spacer (mm)	Without spacer	0 to -10			0 to -12			0 to -16		0 to -24	
	With short spacer	-10 to -20			-12 to -24			-16 to -32		-24 to -48	
	With long spacer	-20 to -30			-24 to -36			-32 to -48		-48 to -72	

* Stroke adjustment range is applicable for one side when mounted on a cylinder.

Stroke Adjustment Unit Symbol

		Right side stroke adjustment unit								
		Without unit		L: With low load shock absorber + Adjustment bolt		H: With high load shock absorber + Adjustment bolt				
Left side stroke adjustment unit	Without unit	Nil	SL	SL6	SL7	SH	SH6	SH7		
	L: With low load shock absorber + Adjustment bolt	Without spacer	LS	L	LL6	LL7	LH	LH6	LH7	
		With short spacer	L6S	L6L	L6	L6L7	L6H	L6H6	L6H7	
	With long spacer	L7S	L7L	L7L6	L7	L7H	L7H6	L7H7		
H: With high load shock absorber + Adjustment bolt	Without spacer	HS	HL	HL6	HL7	H	HH6	HH7		
	With short spacer	H6S	H6L	H6L6	H6L7	H6H	H6	H6H7		
	With long spacer	H7S	H7L	H7L6	H7L7	H7H	H7H6	H7		

* Spacers are used to fix the stroke adjustment unit at an intermediate stroke position.

Shock Absorber Specifications

Type	RB 0806	RB 1007	RB 1412	RB 2015	RB 2725	
Max. energy absorption (J)	0.84	2.4	10.1	29.8	46.6	
Stroke absorption (mm)	6	7	12	15	25	
Max. collision speed (mm/s)	1000					
Max. operating frequency (cycle/min)	80	70	45	25	10	
Spring force (N)	Extended	1.96	4.22	6.86	8.34	8.83
	Compressed	4.22	6.86	15.98	20.50	20.01
Operating temperature range (°C)	5 to 60					

Note) The shock absorber service life is different from that of the MY3A/3B cylinders depending on operating conditions. Allowable operating cycle under the specifications set in this catalog is shown below.

1.2 million times RB08□□
2 million times RB10□□ to RB2725

Note) Specified service life (suitable replacement period) is the value at room temperature (20 to 25°C). The period may vary depending on the temperature and other conditions. In some cases the absorber may need to be replaced before the allowable operating cycle above.

Specifications

Bore size (mm)	16, 20	25, 32	40	50, 63
Fluid	Air			
Action	Double acting			
Operating pressure range	0.2 to 0.8 MPa		0.15 to 0.8 MPa	
Proof pressure	1.2 MPa			
Ambient and fluid temperature	5 to 60°C			
Cushion	Rubber bumper (MY3A) / Air cushion (MY3B)			
Lubrication	Not required (Non-lube)			
Stroke length tolerance	1000 mm or less ± 0.1 , From 1001 mm ± 0.2 (Note)			
Port size (Rc, NPT, G)	M5 x 0.8	1/8	1/4	3/8

Note) The tolerance of the MY3A is a value with no pressurization. When a rubber bumper is used, the stroke of the MY3A varies according to the operating pressure. To find the stroke length tolerance at each operating pressure, double the additional stroke due to pressure on each side (pages 1418 and 1419) and add it.

Piston Speed

Bore size (mm)	16	20	25	32	40	50	63
Without stroke adjustment unit (MY3A)	80 to 500 mm/s						
Without stroke adjustment unit (MY3B)	80 to 1000 mm/s						
Stroke adjustment unit (L and H unit/MY3B)	80 to 1000 mm/s (ø16, ø20 L unit: 80 to 800 mm/s)						
External shock absorber (low reaction type)*	80 to 1500 mm/s						

* Refer to "External Shock Absorber Selection" on pages 1422 and 1423.

When the RB series is used, operate at a piston speed that will not exceed the absorption capacity of the air cushion and stroke adjustment unit.

* Because of its structure, the fluctuation of this cylinder's operating speed is greater than rod type cylinders. For applications that require constant speed, select an applicable equipment for the level of demand.

Stroke adjustment unit mounting diagram

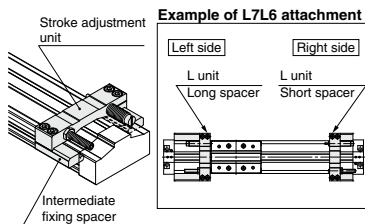

Example of L7L6 attachment

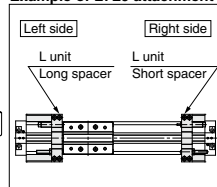

MY1B

MY1H

MY1B

MY1M

MY1C

MY1H

MY1 HT

MY1 □W

MY2C

MY2 H/HT

MY3A

MY3B

MY3M

D-□

-X□

Technical Data

MY3A/3B Series

Theoretical Output

Bore size (mm)	Piston area (mm ²)	Operating pressure (MPa)						
		0.2	0.3	0.4	0.5	0.6	0.7	0.8
16	200	40	60	80	100	120	140	160
20	314	62	94	125	157	188	219	251
25	490	98	147	196	245	294	343	392
32	804	161	241	322	402	483	563	643
40	1256	251	377	502	628	754	879	1005
50	1962	392	588	784	981	1177	1373	1569
63	3115	623	934	1246	1557	1869	2180	2492

Note) Theoretical output (N) = Pressure (MPa) x Piston area (mm²)

Weight

Model	Bore size (mm)	Basic weight	Additional weight per 50 mm stroke	Weight of moving parts	Stroke adjustment unit weight (per unit)	
					L unit weight	H unit weight
					Unit: kg	
MY3A	16	0.21	0.06	0.06		
	20	0.39	0.09	0.12		
	25	0.62	0.11	0.20		
	32	1.25	0.18	0.37		
	40	2.31	0.25	0.67		
	50	3.72	0.40	1.07		
	63	6.46	0.56	2.16		
MY3B	16	0.22	0.06	0.06	0.04	0.05
	20	0.49	0.09	0.12	0.06	0.08
	25	0.71	0.11	0.20	0.10	0.15
	32	1.39	0.18	0.37	0.14	0.22
	40	2.41	0.25	0.67	0.26	0.30
	50	4.10	0.40	1.08	0.38	0.52
	63	7.04	0.56	2.16	0.57	0.92

Calculation method/Example: **MY3B25-300L**

Basic weight 0.71 kg Cylinder stroke 300 st

Additional weight 0.11/50 st

L unit weight 0.1 kg

0.71 + 0.11 x 300 ÷ 50 + 0.1 x 2 = 1.57 kg

Option

Stroke Adjustment Unit Part No.

MY3B-A 25 L2-6N

Stroke adjustment unit

Bore size

16	16 mm
20	20 mm
25	25 mm
32	32 mm
40	40 mm
50	50 mm
63	63 mm

Unit no.

Symbol	Stroke adjustment unit	Mounting position
L1	L unit	Left
L2		Right
H1	H unit	Left
H2		Right

Note) Refer to page 1425 for details about adjustment range.

Intermediate fixing spacer

Nil	Without spacer
6	Short spacer
7	Long spacer

Spacer delivery type

Nil	Unit installed
N	Spacer only

- * Spacers are used to fix the stroke adjustment unit at an intermediate stroke position.
- * Spacers are shipped for a set of two.

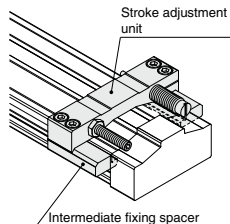

Component Parts

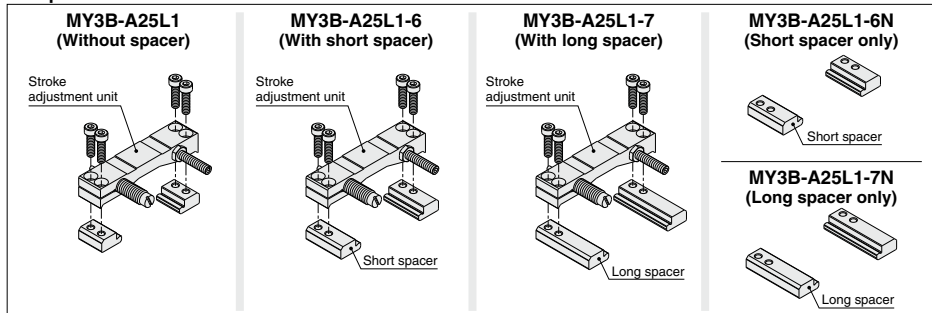

MY3A/3B Series

Construction: $\varnothing 16$, $\varnothing 20$, $\varnothing 25$, $\varnothing 32$, $\varnothing 40$, $\varnothing 50$, $\varnothing 63$

MY3A

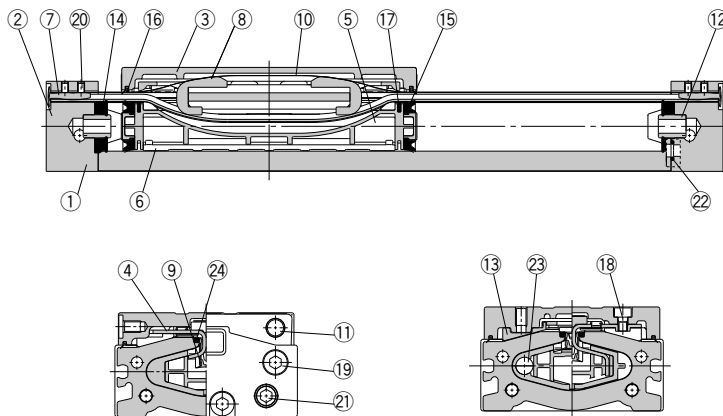

Component Parts

No.	Description	Material	Note
1	Cylinder tube	Aluminum alloy	Hard anodized
2	Head cover	Aluminum alloy	Hard anodized
3	Slide table	Aluminum alloy	Electroless nickel plated
4	Piston yoke	Stainless steel	
5	Piston	Polyamide	
6	Wear ring	Polyacetal	
7	Belt clamp	Polybutylene terephthalate	
8	Belt separator	Polyacetal	
11	Stopper	Carbon steel	Electroless nickel plated

No.	Description	Material	Note
12	Seal ring	Aluminum alloy	Anodized
13	Bearing	Polyacetal	
17	Inner wiper	Special resin	
18	Hexagon socket head cap screw	Chrome molybdenum steel	Chromated
19	Hexagon socket head cap screw	Chrome molybdenum steel	Chromated
20	Hexagon socket head set screw	Chrome molybdenum steel	Chromated
21	Hexagon socket head plug	Carbon steel	Chromated
23	Magnet	—	
24	Seal magnet	Rubber magnet	

Replacement Parts/Seal

No.	Description	Material	Qty.	MY3A16	MY3A20	MY3A25	MY3A32	MY3A40	MY3A50	MY3A63
9	Seal belt	Urethane Polyamide	1	MY3A16-16C-Stroke	MY3A20-16C-Stroke	MY3A25-16C-Stroke	MY3A32-16C-Stroke	MY3A40-16C-Stroke	MY3A50-16C-Stroke	MY3A63-16A-Stroke
10	Dust seal band	Stainless steel	1	MY3A16-16B-Stroke	MY3A20-16B-Stroke	MY3A25-16B-Stroke	MY3A32-16B-Stroke	MY3A40-16B-Stroke	MY3A50-16B-Stroke	MY3A63-16B-Stroke
16	Scraper	Polyamide	1	MYA16-15-R6656	MYA20-15-AC594	MYA25-15-R6657	MYA32-15-AC595	MYA40-15-R6658	MYA50-15-AC596	MYA63-15-R6659
14	Gasket bumper	NBR	2							
15	Piston seal	NBR	2	MY3A16-PS	MY3A20-PS	MY3A25-PS	MY3A32-PS	MY3A40-PS	MY3A50-PS	MY3A63-PS
22	O-ring	NBR	4							

* Seal kit includes 14, 15, and 22. Order the seal kit based on each bore size.

* Seal kit includes a grease pack (10 g).

When 9 and 10 are shipped as single units, a grease pack is included (10 g per 1000 strokes).

Order with the following part number when only the grease pack is needed.

Grease pack part number: GR-S-010 (10 g), GR-S-020 (20 g)

* For instructions on how to replace replacement parts/seals, refer to the operation manual.

MY3A/3B Series

Construction: $\varnothing 16$, $\varnothing 20$, $\varnothing 25$, $\varnothing 32$, $\varnothing 40$, $\varnothing 50$, $\varnothing 63$

MY3B

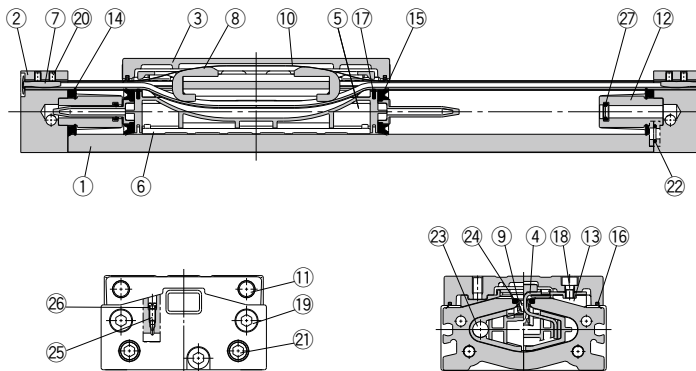

Component Parts

No.	Description	Material	Note
1	Cylinder tube	Aluminum alloy	Hard anodized
2	Head cover	Aluminum alloy	Hard anodized
3	Slide table	Aluminum alloy	Electroless nickel plated
4	Piston yoke	Stainless steel	
5	Piston	Polyamide	
6	Wear ring	Polyacetal	
7	Belt clamp	Polybutylene terephthalate	
8	Belt separator	Polyacetal	
11	Stopper	Carbon steel	Electroless nickel plated
12	Cushion boss	Aluminum alloy	Chromated
13	Bearing	Polyacetal	

No.	Description	Material	Note
17	Inner wiper	Special resin	
18	Hexagon socket head cap screw	Chrome molybdenum steel	Chromated
19	Hexagon socket head cap screw	Chrome molybdenum steel	Chromated
20	Hexagon socket head set screw	Chrome molybdenum steel	Chromated
21	Hexagon socket head plug	Carbon steel	Chromated
23	Magnet	—	
24	Seal magnet	Rubber magnet	
25	Cushion needle	Rolled steel	Nickel plated

Replacement Parts/Seal

No.	Description	Material	Qty.	MY3B16	MY3B20	MY3B25	MY3B32	MY3B40	MY3B50	MY3B63
9	Seal belt	Urethane Polyamide	1	MY3B16-16C- [Stroke]	MY3B20-16C- [Stroke]	MY3B25-16C- [Stroke]	MY3B32-16C- [Stroke]	MY3B40-16C- [Stroke]	MY3B50-16C- [Stroke]	MY3B63-16A- [Stroke]
10	Dust seal band	Stainless steel	1	MY3B16-16B- [Stroke]	MY3B20-16B- [Stroke]	MY3B25-16B- [Stroke]	MY3B32-16B- [Stroke]	MY3B40-16B- [Stroke]	MY3B50-16B- [Stroke]	MY3B63-16B- [Stroke]
16	Scraper	Polyamide	1	MYA16-15- R6656	MYA20-15- AC594	MYA25-15- R6657	MYA32-15- AC595	MYA40-15- R6658	MYA50-15- AC596	MYA63-15- R6659
26	O-ring	NBR	2	KA00309 ($\varnothing 4 \times \varnothing 1.8 \times \varnothing 1.1$)	KA00309 ($\varnothing 4 \times \varnothing 1.8 \times \varnothing 1.1$)	KA00309 ($\varnothing 4 \times \varnothing 1.8 \times \varnothing 1.1$)	KA00309 ($\varnothing 4 \times \varnothing 1.8 \times \varnothing 1.1$)	KA00320 ($\varnothing 7.15 \times \varnothing 3.75 \times \varnothing 1.7$)	KA00320 ($\varnothing 7.15 \times \varnothing 3.75 \times \varnothing 1.7$)	KA00402 ($\varnothing 6.3 \times \varnothing 4.5 \times \varnothing 1.9$)
14	Tube gasket	NBR	2	MY3B16-PS	MY3B20-PS	MY3B25-PS	MY3B32-PS	MY3B40-PS	MY3B50-PS	MY3B63-PS
15	Piston seal	NBR	2							
22	O-ring	NBR	4							
27	Cushion seal	NBR	2							

* Seal kit includes 14, 15, 22 and 27. Order the seal kit based on each bore size.

* Seal kit includes a grease pack (10 g).

When ⑨ and ⑩ are shipped as single units, a grease pack is included (10 g per 1000 strokes).
Order with the following part number when only the grease pack is needed.

Grease pack part number: GR-S-010 (10 g), GR-S-020 (20 g)

* For instructions on how to replace replacement parts/seals, refer to the operation manual.

Short Type: $\varnothing 16, \varnothing 20, \varnothing 25, \varnothing 32, \varnothing 40, \varnothing 50, \varnothing 63$

MY3A -

* Refer to "Specific Product Precautions" on page 1453 for mounting.

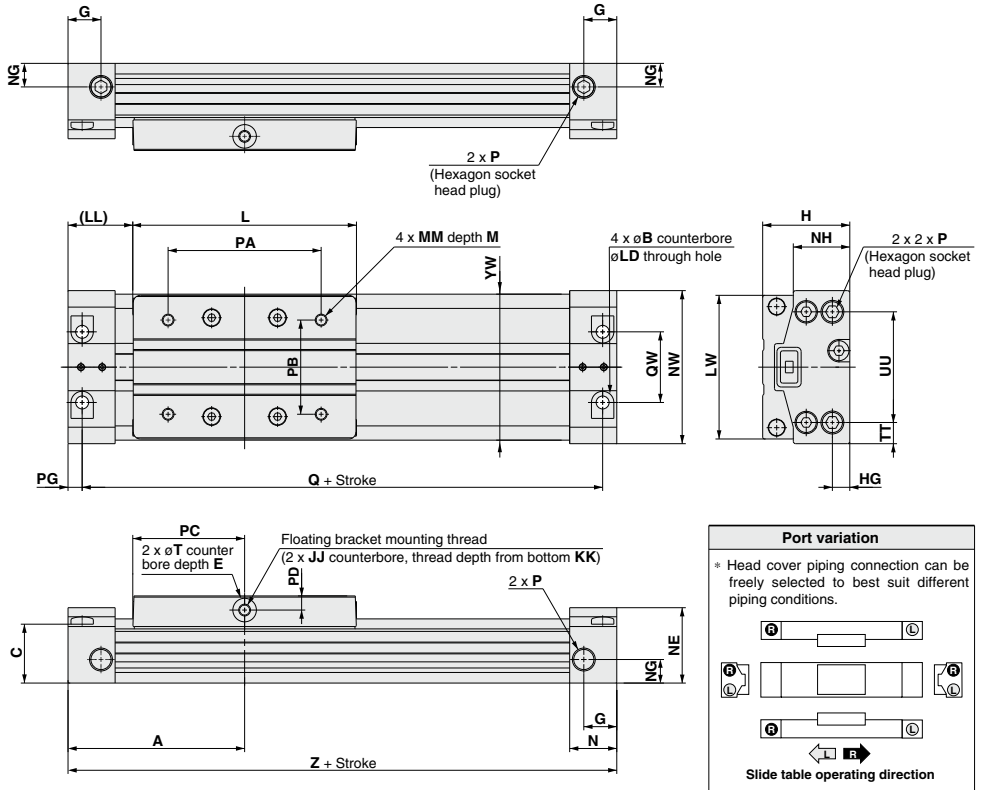

- MY1B
- MY1H
- MY1B
- MY1M
- MY1C
- MY1H
- MY1 HT
- MY1 □ W
- MY2C
- MY2 H/HT
- MY3A
- MY3B
- MY3M

(mm)

Model	A	B	C	E	G	H	HG	JJ	KK	L	LD	LL	LW	M	MM	N
MY3A16	55	6	18	2	9.5	27	5	M4 x 0.7	5	65	3.5	22.5	41	6	M4 x 0.7	13.5
MY3A20	64	7.5	22	2	9.5	32	6.5	M4 x 0.7	8.5	80	4.5	24	51	6	M4 x 0.7	15.5
MY3A25	75	9.5	25	2	14	37	7.4	M5 x 0.8	7.5	95	5.5	27.5	61	8	M5 x 0.8	20
MY3A32	96.5	11	32.5	2	14	45	9	M5 x 0.8	7.5	128	6.6	32.5	76	8	M5 x 0.8	22.5
MY3A40	120	14	38	2	18	54	12	M6 x 1	12	160	8.6	40	90	12	M6 x 1	27
MY3A50	137	14	49	3	16	67	14	M6 x 1	15.5	190	9	42	112	12	M6 x 1	27
MY3A63	160	17	60	3	20.5	84	16.5	M8 x 1.25	22	220	11	50	134	16	M8 x 1.25	31

Model	NE	NG	NH	NW	P	PA	PB	PC	PD	PG	Q	QW	T	TT	UU	YW	Z
MY3A16	22.5	8	17.2	43	M5 x 0.8	44	26	32.5	4	4	102	19	7	6.5	30	42	110
MY3A20	27.5	10	20.8	53	M5 x 0.8	54	30	40	5	4.5	119	23	8	9	35	52	128
MY3A25	32	10	24	65	Rc, NPT, G1/8	64	40	47.5	6	6	138	30	10	9	47	62	150
MY3A32	39	14	31	79	Rc, NPT, G1/8	92	44	64	6	7	179	33	10	13.5	52	77	193
MY3A40	46	15	37	94	Rc, NPT, G1/4	112	60	80	7.5	8.5	223	40	14	14	66	92	240
MY3A50	58	25	47.5	116	Rc, NPT, G3/8	142	66	95	8.5	8.5	257	44	15	21	74	114	274
MY3A63	70	29	58	139	Rc, NPT, G3/8	162	84	110	10	10	300	64	16	20	99	136	320

- D-□
- X□
- Technical Data

MY3A/3B Series

Standard Type: $\varnothing 16, \varnothing 20, \varnothing 25, \varnothing 32, \varnothing 40, \varnothing 50, \varnothing 63$

MY3B Bore size – Stroke

* Refer to "Specific Product Precautions" on page 1453 for mounting.

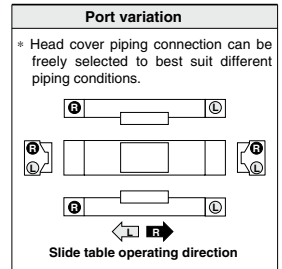
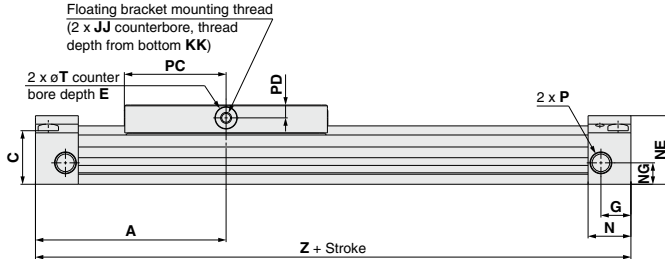
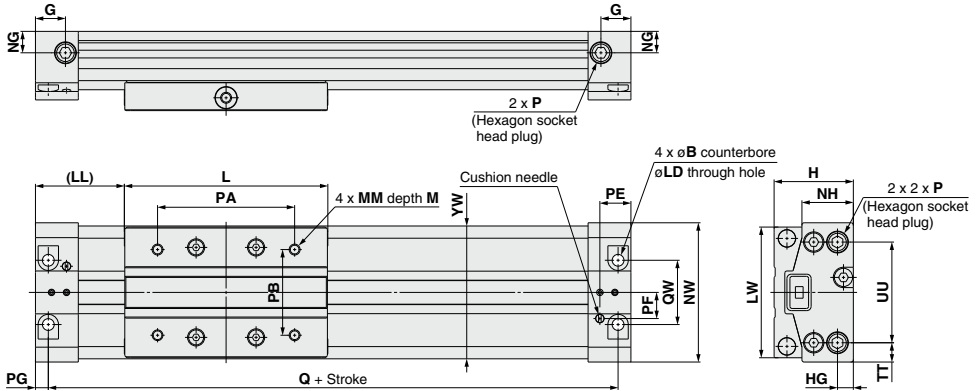

Model	A	B	C	E	G	H	HG	JJ	KK	L	LD	LL	LW	M	MM	N
MY3B16	61	6	18	2	9.5	27	5	M4 x 0.7	5	65	3.5	28.5	41	6	M4 x 0.7	13.5
MY3B20	74	7.5	22	2	9.5	32	6.5	M4 x 0.7	8.5	80	4.5	34	51	6	M4 x 0.7	15.5
MY3B25	89	9.5	25	2	14	37	7.4	M5 x 0.8	7.5	95	5.5	41.5	61	8	M5 x 0.8	20
MY3B32	112.5	11	32.5	2	14	45	9	M5 x 0.8	7.5	128	6.6	48.5	76	8	M5 x 0.8	22.5
MY3B40	138	14	38	2	18	54	12	M6 x 1	12	160	8.6	58	90	12	M6 x 1	27
MY3B50	155	14	49	3	16	67	14	M6 x 1	15.5	190	9	60	112	12	M6 x 1	27
MY3B63	178	17	60	3	20.5	84	16.5	M8 x 1.25	22	220	11	68	134	16	M8 x 1.25	31

Model	NE	NG	NH	NW	P	PA	PB	PC	PD	PE	PF	PG	Q	QW	T	TT	UU	YW	Z
MY3B16	22.5	8	17.2	43	M5 x 0.8	44	26	32.5	4	9.7	8.5	4	114	19	7	6.5	30	42	122
MY3B20	27.5	10	20.8	53	M5 x 0.8	54	30	40	5	11.2	10	4.5	139	23	8	9	35	52	148
MY3B25	32	10	24	65	Rc, NPT, G1/8	64	40	47.5	6	14.5	12.2	6	166	30	10	9	47	62	178
MY3B32	39	14	31	79	Rc, NPT, G1/8	92	44	64	6	16	15	7	211	33	10	13.5	52	77	225
MY3B40	46	15	37	94	Rc, NPT, G1/4	112	60	80	7.5	19.5	16.5	8.5	259	40	14	14	66	92	276
MY3B50	58	25	47.5	116	Rc, NPT, G3/8	142	66	95	8.5	20.5	20	8.5	293	44	15	21	74	114	310
MY3B63	70	29	58	139	Rc, NPT, G3/8	162	84	110	10	23.5	27.5	10	336	64	16	20	99	136	356

Standard Type: $\varnothing 16, \varnothing 20, \varnothing 25, \varnothing 32, \varnothing 40, \varnothing 50, \varnothing 63$

Stroke adjustment unit

Low load shock absorber + Adjustment bolt

MY3B Bore size – Stroke L

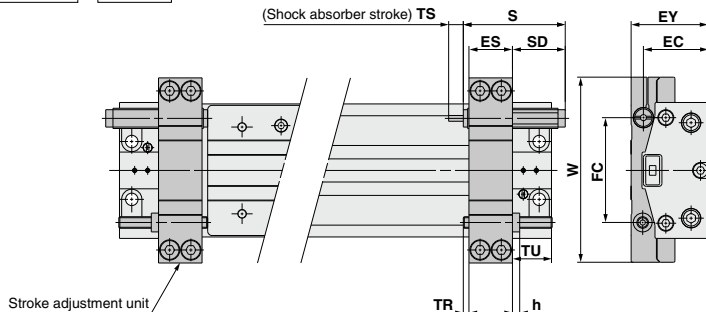

Applicable cylinder	ES	EC	EY	FC	h	S	SD	TS	TR	TU	W	Shock absorber model
MY3B16	14.1	21.5	26.5	34.5	2.4	40.8	25.8	6	0.9	25	62	RB0806
MY3B20	14.1	26.5	31.5	41	2.4	40.8	22.3	6	4.4	21.5	72	RB0806
MY3B25	20.1	29.8	36.5	51.5	3.6	46.7	25.2	7	1.4	28.5	90	RB1007
MY3B32	20.1	37.5	44.5	60	3.6	46.7	20.7	7	5.9	24	105	RB1007
MY3B40	30.1	45	53.5	72.5	5	67.3	36.3	12	0.9	39	128	RB1412
MY3B50	30.1	56.5	66.5	88	5	67.3	34.3	12	2.9	37	150	RB1412
MY3B63	36.1	70.5	83.5	108	6	73.2	36.2	15	0.9	43	178	RB2015

Note) When the stroke adjustment unit is used, the fitting type, which can be connected with the port on the body front and the back, will be limited. Refer to page 1411 for details.

Heavy-loaded shock absorber + Adjustment bolt

MY3B Bore size – Stroke H

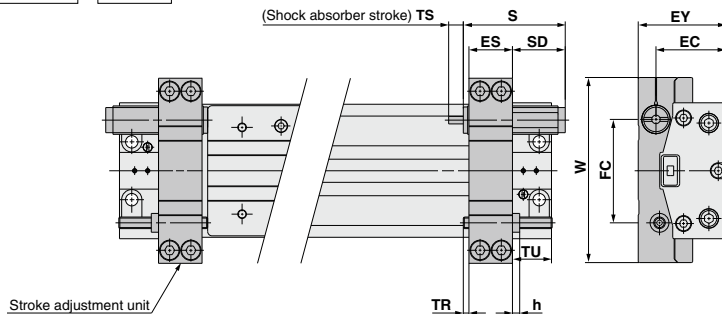

Applicable cylinder	ES	EC	EY	FC	h	S	SD	TS	TR	TU	W	Shock absorber model
MY3B16	14.1	23	29.5	34.5	2.4	46.7	31.7	7	0.9	25	62	RB1007
MY3B20	14.1	27.5	34	41	2.4	46.7	28.2	7	4.4	21.5	72	RB1007
MY3B25	20.1	31.8	41	52.2	3.6	67.3	45.8	12	1.4	28.5	90	RB1412
MY3B32	20.1	39.5	49	60.5	3.6	67.3	41.3	12	5.9	24	105	RB1412
MY3B40	30.1	48	60.5	73.5	5	73.2	42.2	15	0.9	39	128	RB2015
MY3B50	30.1	58.5	71	88.5	5	73.2	40.2	15	2.9	37	150	RB2015
MY3B63	36.1	74.5	91	108	6	99	62	25	0.9	43	178	RB2725

Note) When the stroke adjustment unit is used, the fitting type, which can be connected with the port on the body front and the back, will be limited. Refer to page 1411 for details.

- MY1B
- MY1H
- MY1B
- MY1M
- MY1C
- MY1H
- MY1 HT
- MY1 W
- MY2C
- MY2 H/HT
- MY3A
- MY3B
- MY3M

- D-□
- X□
- Technical Data

MY3A/3B Series

Side Support

Side support A MY-S□A

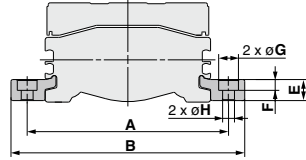
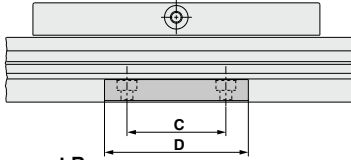

Side support B MY-S□B

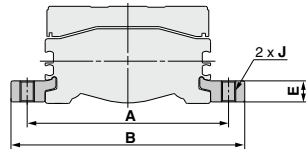
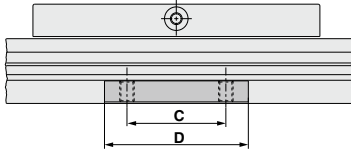

Model	Applicable cylinder	A	B	C	D	E	F	G	H	J
MY-S16 $\frac{1}{2}$	MY3A16-MY3B16	53	63.6	15	26	4.9	3	6.5	3.4	M4 x 0.7
MY3-S20 $\frac{1}{2}$	MY3A20-MY3B20	65	77.6	25	38	5.9	3.5	8	4.5	M5 x 0.8
MY-S25 $\frac{1}{2}$	MY3A25-MY3B25	77	91	35	50	8	5	9.5	5.5	M6 x 1
MY-S32 $\frac{1}{2}$	MY3A32-MY3B32	97	115	45	64	11.7	6	11	6.6	M8 x 1.25
	MY3A40-MY3B40	112	130							
MY-S50 $\frac{1}{2}$	MY3A50-MY3B50	138	160	55	80	14.8	8.5	14	9	M10 x 1.5
	MY3A63-MY3B63	160	182							

(mm)
(Note) A set of side supports consists of a left support and a right support.

Guide for Using Side Support

For long stroke operation, the cylinder tube may be deflected depending on its own weight and the load weight. In such a case, use a side support in the middle section. The spacing (L) of the support must be no more than the values shown in the graph on the right.

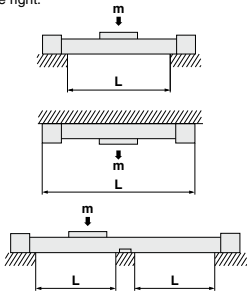

Guide for Using MY3A Side Support

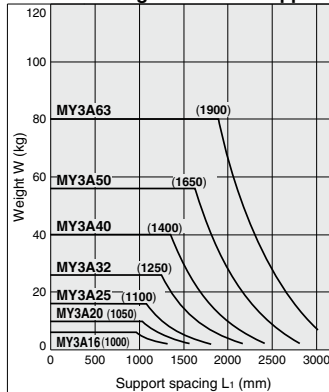

(Note) A side support must be used to keep the spacing from exceeding the value inside the parentheses.

Guide for Using MY3B Side Support

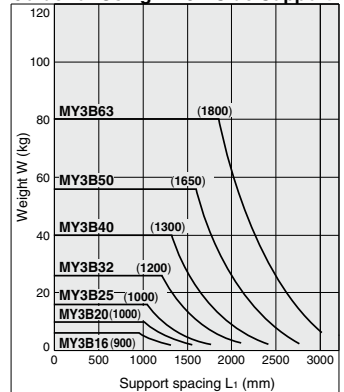

(Note) A side support must be used to keep the spacing from exceeding the value inside the parentheses.

⚠ Caution

- If the cylinder mounting surfaces are not measured accurately, using a side support may cause poor operation. Therefore, be sure to level the cylinder tube when mounting. Also, for long stroke operation involving vibration and impact, use of a side support is recommended even if the spacing value is within the allowable limits shown in the graph.
- Support brackets are not for mounting; use them solely for providing support.

Floating Bracket

Facilitates connection to other guide systems.

Application

Mounting direction ① (to minimize the installation height)

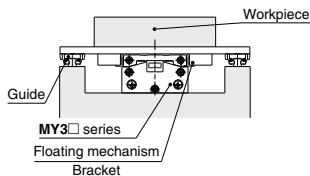

Mounting Example

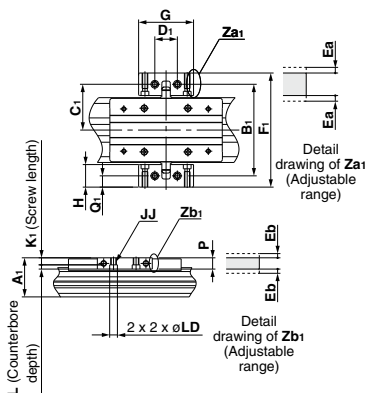

Application

Mounting direction ② (to minimize the installation width)

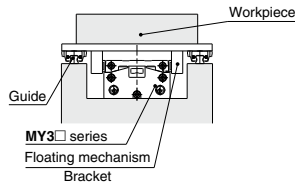

Mounting Example

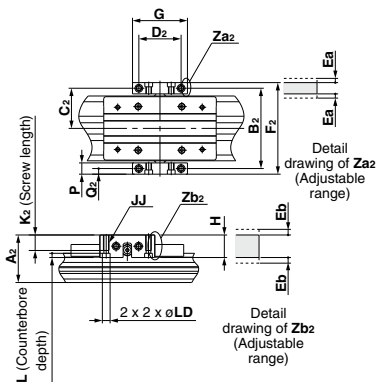

MY3 Floating Bracket Mounting Dimensions

Model	Applicable cylinder	Common							Adjustment range	
		G	H	JJ	L	P	LD	Ea	Eb	
MYAJ16	MY3□16	38	20	M4 x 0.7	4.5	10	6	1	1	
MYAJ20	MY3□20	50	21	M4 x 0.7	4	10	6.5	1	1	
MYAJ25	MY3□25	55	22	M6 x 1	5.5	12	9.5	1	1	
MYAJ32	MY3□32	60	22	M6 x 1	5.5	12	9.5	1	1	

Model	Applicable cylinder	Mounting direction ①							
		A1	B1	C1	D1	F1	K1	Q1	
MYAJ16	MY3□16	29	68	34	18	88	5.5	10	
MYAJ20	MY3□20	34	81	40.5	20	102	6	10.5	
MYAJ25	MY3□25	38.5	90	45	24	112	6.5	11	
MYAJ32	MY3□32	47	106	53	30	128	6.5	11	

Model	Applicable cylinder	Mounting direction ②						
		A2	B2	C2	D2	F2	Q2	
MYAJ16	MY3□16	36	58	29	30	68	10	5
MYAJ20	MY3□20	41	70	35	35	80	10	5
MYAJ25	MY3□25	46	80	40	40	92	14	6
MYAJ32	MY3□32	54	96	48	46	108	14	6

Note) Floating brackets are shipped as a set of left and right brackets.

Model	Applicable cylinder	Common							Adjustment range	
		G	H	JJ	L	P	LD	Ea	Eb	
MYAJ40	MY3□40	72	32	M8 x 1.25	6.5	16	11	1	1	
MYAJ50	MY3□50	90	36	M8 x 1.25	6.5	16	11	1	1	
MYAJ63	MY3□63	100	40	M10 x 1.5	9	19	14	1	1	

Model	Applicable cylinder	Mounting direction ①							
		A1	B1	C1	D1	F1	K1	Q1	
MYAJ40	MY3□40	56	130	65	32	162	16	11	1
MYAJ50	MY3□50	69	156	78	40	192	9.5	18	
MYAJ63	MY3□63	86	186	93	50	226	10	20	

Model	Applicable cylinder	Mounting direction ②						
		A2	B2	C2	D2	F2	Q2	
MYAJ40	MY3□40	68	114	57	55	130	19	8
MYAJ50	MY3□50	81	136	68	70	152	20	8
MYAJ63	MY3□63	100	166	83	80	185	23	9.5

MYAJ (1 set) Component Parts

Description	Qty.
Bracket	2
Pin	2
Conical spring washer	2
Holding bolts	2

Installation of Holding Bolts

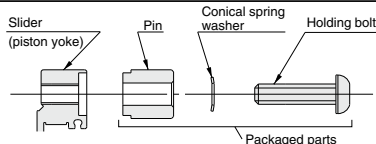

Tightening Torque for Holding Bolts

Model	Tightening torque	Model	Tightening torque
MYAJ16	1.5	MYAJ40	5
MYAJ20	1.5	MYAJ50	5
MYAJ25	3	MYAJ63	13
MYAJ32	3		

Unit: N·m

MY1B

MY1H

MY1B

MY1M

MY1C

MY1H

MY1 HT

MY1 □W

MY2C

MY2 H/HT

MY3A

MY3B

MY3M

D-□

X-□

Technical Data

MY3M Series

Slide bearing guide type
(Air cushion)

ø16, ø25, ø40, ø63

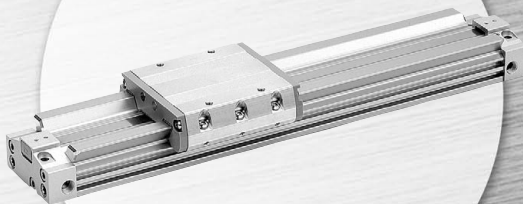

MY1B

MY1H

MY1B

MY1M

MY1C

MY1H

MY1
HT

MY1
W

MY2C

MY2
H/HT

MY3A
MY3B

MY3M

D-

-X

Technical
Data

MY3M Series Model Selection

The following are steps for selecting the MY3 series which is best suited to your application.

Calculation of Guide Load Factor

1 Operating Conditions

Cylinder MY3M25-500
 Average operating speed v_a 300 mm/s
 Mounting direction Wall mounting
 Cushion Air cushion ($\delta = 1/100$)

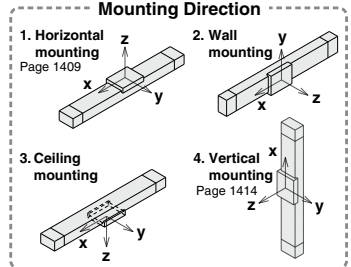
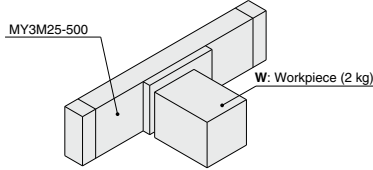

Refer to the pages mentioned above for actual examples of calculation for each orientation.
 * For ceiling mounting, refer to page 1280.

2 Load Blocking

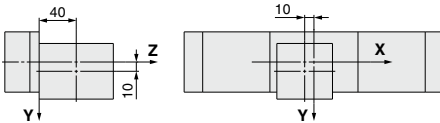

Workpiece Mass and Center of Gravity

Workpiece no.	Mass (m)	Center of gravity		
		X-axis	Y-axis	Z-axis
W	2 kg	10 mm	10 mm	40 mm

3 Calculation of Load Factor for Static Load

m₃: Mass

m₃ max (from ① of graph MY3M / m₃) = 5.33 (kg)

Load factor $\alpha_1 = m_3 / m_3 \text{ max} = 2 / 5.33 = 0.38$

M₂: Moment

M₂ max (from ② of graph MY3M / M₂) = 6 (N·m)

M₂ = m₃ × g × Z = 2 × 9.8 × 40 × 10⁻³ = 0.78 (N·m)

Load factor $\alpha_2 = M_2 / M_2 \text{ max} = 0.78 / 6 = 0.13$

M₃: Moment

M₃ max (from ③ of graph MY3M / M₃) = 2.67 (N·m)

M₃ = m₃ × g × X = 2 × 9.8 × 10 × 10⁻³ = 0.2 (N·m)

Load factor $\alpha_3 = M_3 / M_3 \text{ max} = 0.2 / 2.67 = 0.07$

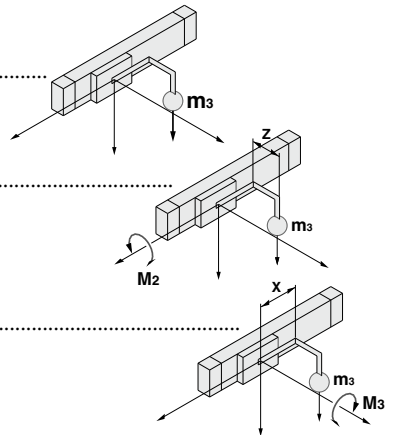

Calculation of Guide Load Factor

4 Calculation of Load Factor for Dynamic Moment

Equivalent load F_E at impact

$$F_E = 1.4Ua \times \delta \times m \times g = 1.4 \times 300 \times \frac{1}{100} \times 2 \times 9.8 = 82.38 \text{ (N)}$$

M_{1E} : Moment

$M_{1E} \text{ max}$ (from ④ of graph MY3M/ M_1 where $1.4Ua = 420 \text{ mm/s}$) = 7.62 (N-m)

$$M_{1E} = \frac{1}{3} \times F_E \times Z = \frac{1}{3} \times 82.38 \times 40 \times 10^{-3} = 1.10 \text{ (N-m)}$$

$$\text{Load factor } \alpha_4 = M_{1E} / M_{1E} \text{ max} = 1.10 / 7.62 = 0.14$$

M_{3E} : Moment

$M_{3E} \text{ max}$ (from ⑤ graph of MY3M/ M_3 where $1.4Ua = 420 \text{ mm/s}$) = 1.90 (N-m)

$$M_{3E} = \frac{1}{3} \times F_E \times Y = \frac{1}{3} \times 82.38 \times 10 \times 10^{-3} = 0.27 \text{ (N-m)}$$

$$\text{Load factor } \alpha_5 = M_{3E} / M_{3E} \text{ max} = 0.27 / 1.90 = 0.14$$

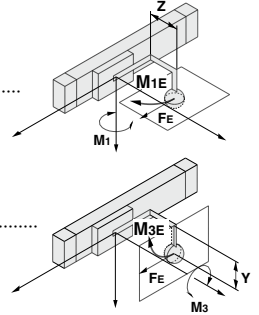

5 Sum and Examination of Guide Load Factors

$$\Sigma\alpha = \alpha_1 + \alpha_2 + \alpha_3 + \alpha_4 + \alpha_5 = 0.87 \leq 1$$

The above calculation is within the allowable value, and therefore the selected model can be used.

Select a shock absorber separately.

In an actual calculation, when the sum of guide load factors $\Sigma\alpha$ in the formula above is more than 1, consider decreasing the speed, increasing the bore size, or changing the product series. This calculation can be easily made using the "SMC Pneumatic CAD System".

Load Mass

MY3M, m_3

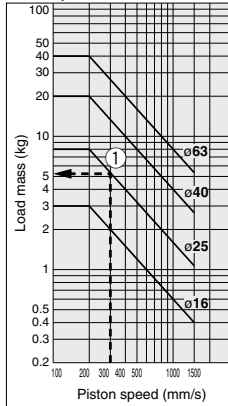

Allowable Moment

MY3M, M_1

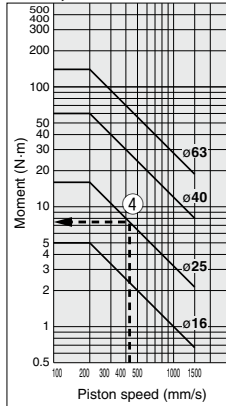

MY3M, M_2

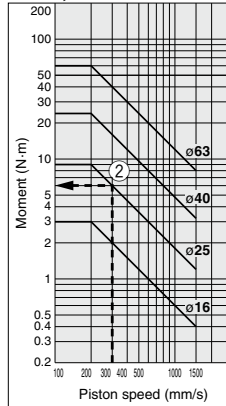

MY3M, M_3

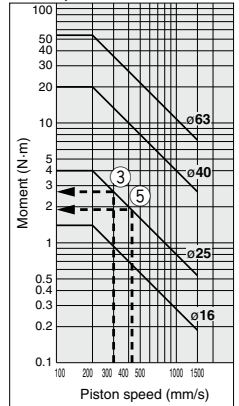

MY1B

MY1H

MY1B

MY1M

MY1C

MY1H

MY1 HT

MY1 W

MY2C

MY2 H/HT

MY3A

MY3B

MY3M

D-

-X

Technical Data

MY3M Series

Maximum Allowable Moment / Maximum Allowable Load

Model	Bore size (mm)	Maximum allowable moment (N·m)			Maximum allowable load (kg)		
		M ₁	M ₂	M ₃	m ₁	m ₂	m ₃
MY3M	16	5	3	1.4	18	14	3
	25	16	9	4	38	36	8
	40	60	24	20	84	81	20
	63	140	60	54	180	163	40

Recommended direction of applying M₂ moment

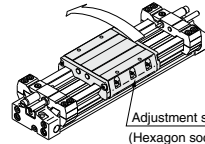

Adjustment side
(Hexagon socket button head screw side)

* We recommend that the static M₂ moment direction should be as illustrated. Also, when using the product in a wall mount application (m₃ applied), we recommend that the mounting orientation of the adjustment side (hexagon socket head button bolt side) should be in the upper position.

Select the moment from within the range of operating limits shown in the graphs. Note that the maximum allowable load value may sometimes be exceeded even within the operating limits shown in the graphs. Therefore, also check the allowable load for the selected conditions.

Maximum Allowable Moment

MY3M, M₁

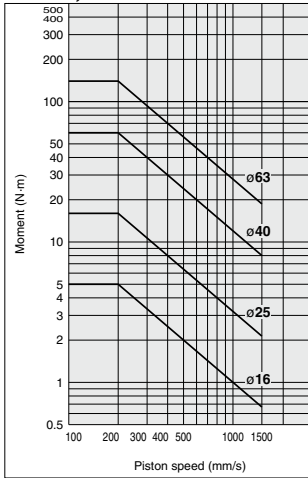

MY3M, M₂

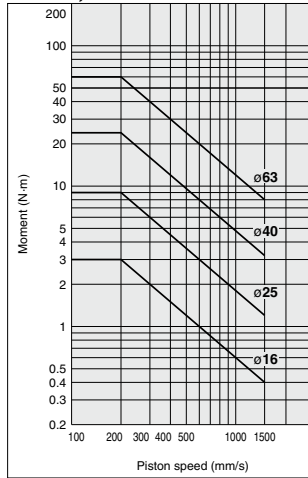

MY3M, M₃

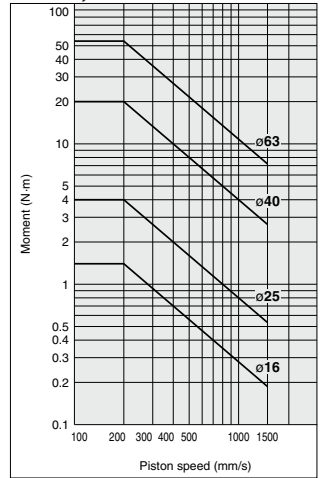

Maximum Allowable Load

Select the load from within the range of limits shown in the graphs. Note that the maximum allowable moment value may sometimes be exceeded even within the operating limits shown in the graphs. Therefore, also check the allowable moment for the selected conditions.

MY3M, m₁

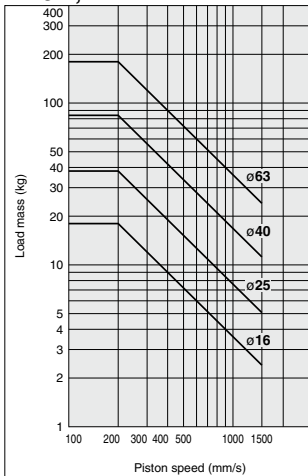

MY3M, m₂

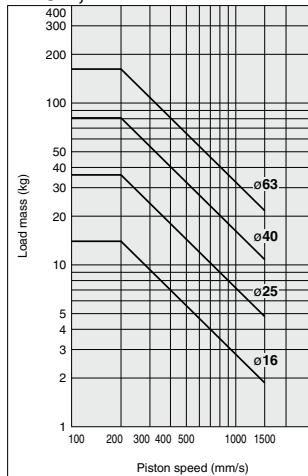

MY3M, m₃

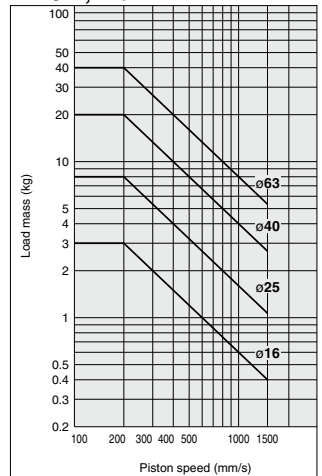

Cushion Capacity

Absorption Capacity of Air Cushion and Stroke Adjustment Unit

MY3M16

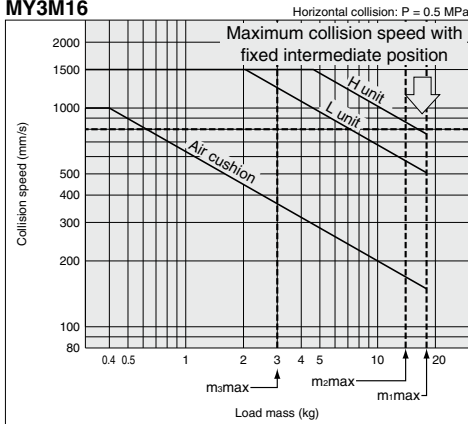

MY3M25

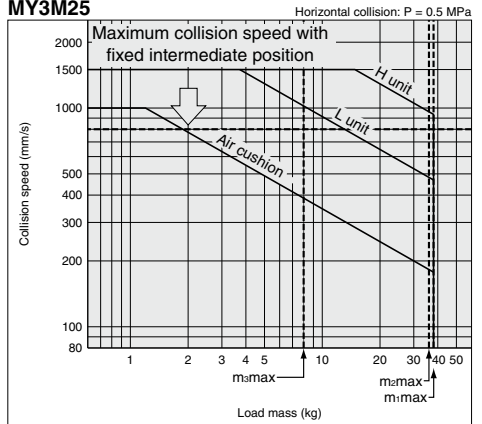

MY3M40

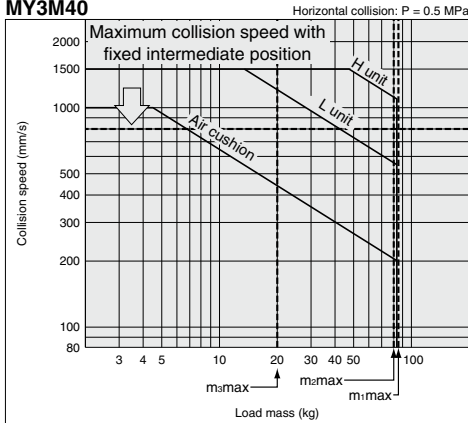

MY3M63

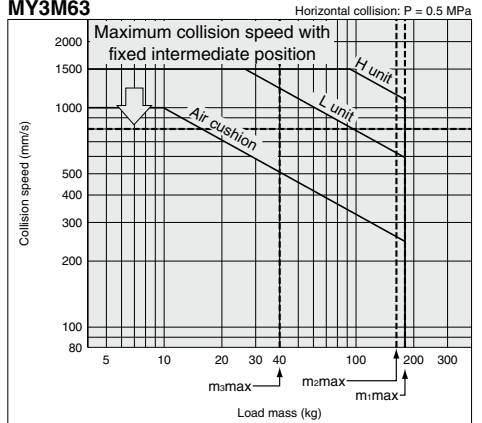

Air Cushion Stroke

Unit: mm

Bore size (mm)	Cushion stroke
16	13
25	18
40	25
63	30

MY1B

MY1H

MY1B

MY1M

MY1C

MY1H

MY1 HT

MY1 □W

MY2C

MY2 H/HT

MY3A

MY3B

MY3M

D-□

-X□

Technical Data

Cushion Capacity

Absorption Capacity of Air Cushion and Stroke Adjustment Unit

Calculation of Absorbed Energy for Stroke Adjustment Unit with Built-in Shock Absorber Unit: N·m

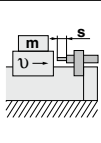
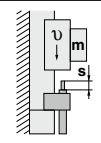
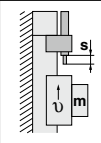
Type of collision	Horizontal	Vertical (Downward)	Vertical (Upward)
			
Kinetic energy E ₁	$\frac{1}{2} m \cdot v^2$		
Thrust energy E ₂	F · s	F · s + m · g · s	F · s - m · g · s
Absorbed energy E	E ₁ + E ₂		

Stroke Adjustment Unit Fine Stroke Adjustment Range Unit: mm

Bore size (mm)	Fine stroke adjustment range
16	0 to -10
25	0 to -12
40	0 to -16
63	0 to -24

Note) The maximum operating speed will differ when the stroke adjustment unit is used outside the maximum fine stroke adjustment range (with reference to the fixed stroke end), such as at a fixed intermediate position (X416, X417). (Refer to the graph on page 1441.)

Symbols

v: Speed of impacting object (m/s)

m: Weight of impacting object (kg)

F: Cylinder thrust (N)

g: Gravitational acceleration (9.8 m/s²)

s: Shock absorber stroke (m)

Note) The speed of the impacting object is measured at the time of collision with the shock absorber.

Stroke Adjustment

<Stroke adjustment of the adjustment bolt>

Loosen the lock nut for the adjustment bolt, adjust the stroke on the head cover side with a hexagon wrench, and secure with a lock nut.

<Stroke adjustment of the shock absorber>

Loosen the fixing bolts on the shock absorber side and rotate the shock absorber for stroke adjustment. Tighten the fixing bolts to secure the shock absorber. Use caution not to overtighten the fixing bolts.

(Refer to "Stroke Adjustment Unit Tightening Torque for Fixing Bolts.")

Stroke Adjustment Unit

Tightening Torque for Fixing Bolts Unit: N·m

Bore size (mm)	Unit	Tightening torque
16	L	0.7
	H	
25	L	3.5
	H	
40	L	13.8
	H	
63	L	27.5
	H	

Shock Absorber

Tightening Torque for Fixing Bolts Unit: N·m

Bore size (mm)	Unit	Tightening torque
16	L	0.6
	H	
25	L	1.5
	H	
40	L	3.0
	H	
63	L	5.0
	H	

⚠ Caution

1. Use caution not to have your hands caught in the unit.

When using a cylinder with stroke adjustment unit, the space between the slide table (slider) and the stroke adjustment unit is very narrow. Care should be taken to avoid the danger of hands being caught in this small space. Install a protective cover to prevent the risk of accidents to the human body.

⚠ Caution

2. The stroke adjustment unit may interfere with the mounting bolt when mounting the cylinder on the equipment.

Loosen the unit fixing bolt and dislocate the stroke adjustment unit before mounting the cylinder. After fixing the cylinder, move the stroke adjustment unit back to the desired location and tighten the unit fixing bolt.

Use caution not to overtighten the fixing bolts.

(Refer to "Stroke Adjustment Unit Tightening Torque for Fixing Bolts.")

3. When using the adjust bolt to perform stroke adjustment, fix the adjust bolt so that it is on the same side as the shock absorber.

Fix the adjust bolt on the same side as the shock absorber that was used for stroke adjustment.

If the shock absorber's stopper side and the front end of the adjust bolt are not on the same side, the slide table stopping position becomes unstable, and durability may drop.

4. Securing the unit body

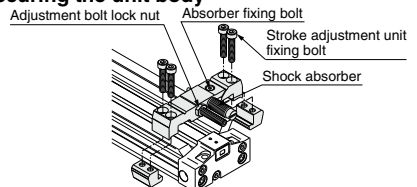

Tighten the four unit fixing bolts equally to secure the unit body.

5. Do not fix and use the stroke adjustment unit at an intermediate position.

When the stroke adjustment unit is fixed in an intermediate position, slippage can occur depending on the amount of energy released at the time of an impact. In that case, use a short spacer or a long spacer. For other lengths, please consult with SMC.

(Refer to "Stroke Adjustment Unit Tightening Torque for Fixing Bolts.")

If the stroke adjustment unit is fixed at an intermediate position, the energy absorption capacity may be different. For this reason, refer to the maximum absorbed energy listed above, and use the adjustment unit within the allowable absorption capacity.

Mechanically Jointed Rodless Cylinder

Slide bearing guide type

MY3M Series

∅16, ∅25, ∅40, ∅63

How to Order

Slide bearing guide type

MY3 M 16 - **300** - **M9BW** -

Slide bearing guide type

Cylinder bore size

16	16 mm
25	25 mm
40	40 mm
63	63 mm

Port thread type

Symbol	Type	Bore size
Nil	M5	∅16
	Rc	
TN	NPT	∅25, ∅40, ∅63
TF	G	

Cylinder stroke (mm)

Bore size (mm)	Standard stroke (mm)*	Maximum manufacturable stroke (mm)
16, 25, 40, 63	100, 200, 300, 400, 500, 600 700, 800, 900, 1000, 1200 1400, 1600, 1800, 2000	3000

* Strokes are manufacturable in 1 mm increments, up to the maximum stroke. However, when the stroke is 49 mm or less, the air cushion capability lowers and multiple auto switches cannot be mounted. Pay special attention to this point. Also when exceeding a 2000 mm stroke, specify "-XB11" at the end of the model number. For details, refer to the "Made to Order Specifications".

Made to Order

Refer to page 1445 for details.

Number of auto switches

Nil	2 pcs.
S	1 pc.
n	"n" pcs.

Auto switch

Nil	Without auto switch (Built-in magnet)
-----	---------------------------------------

* Refer to the table below for auto switch model numbers.

Stroke adjustment unit symbol

Refer to "Stroke adjustment unit" on page 1445.

Applicable Auto Switches

Refer to pages 1575 to 1701 for further information on auto switches.

Type	Special function	Electrical entry	Indicator light	Wiring (Output)	Load voltage		Auto switch model		Lead wire length (m)				Pre-wired connector	Applicable load	
					DC	AC	Perpendicular	In-line	0.5 (Nil)	1 (M)	3 (L)	5 (Z)		IC circuit	Relay, PLC
Solid state auto switch	—	Grommet	Yes	3-wire (NPN)	5 V, 12 V	—	M9NV	M9N	●	●	○	○	IC circuit	Relay, PLC	
				3-wire (PNP)			M9PV	M9P	●	●	○	○			
				2-wire	M9BV		M9B	●	●	○	○	—			
				3-wire (NPN)	M9NWW		M9NW	●	●	○	○	IC circuit			
	Diagnostic indication (2-color indicator)			3-wire (PNP)	M9PWW		M9PW	●	●	○	○	IC circuit			
				2-wire	M9BWW		M9BW	●	●	○	○	—			
				3-wire (NPN)	M9NAV ^{*1}		M9NA ^{*1}	○	○	●	●	IC circuit			
				3-wire (PNP)	M9PAV ^{*1}		M9PA ^{*1}	○	○	●	●	IC circuit			
Water resistant (2-color indicator)	2-wire	M9BAV ^{*1}	M9BA ^{*1}	○	○	●	●	—							
	—	Grommet	Yes	3-wire (NPN equiv.)	—	5 V	—	A96V	A96	●	—	—	IC circuit	—	
				2-wire	24 V	12 V	100 V	A93V ^{*2}	A93	●	●	●	—	—	Relay, PLC
	No	—	—	—	100 V or less	A90V	A90	●	—	●	—	—	IC circuit	—	

*1 Water resistant type auto switches can be mounted on the above models, but in such case SMC cannot guarantee water resistance.

Consult with SMC regarding water resistant types with the above model numbers.

*2 1 m type lead wire is only applicable to D-A93.

* Lead wire length symbols: 0.5 m Nil (Example) M9NV
1 m M (Example) M9NWM
3 m L (Example) M9NWL
5 m Z (Example) M9NZZ

* Solid state auto switches marked with "○" are produced upon receipt of order.
* Separate switch spacers (BM93-016) are required for retrofitting of auto switches.

* There are other applicable auto switches than listed above. For details, refer to page 1451.

* Refer to pages 1648 to 1649 for the details of auto switches with a pre-wired connector.

* Auto switches are shipped together (not assembled). (Refer to page 1451 for the details of auto switch mounting.)

Specifications

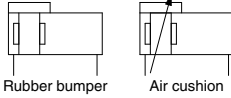
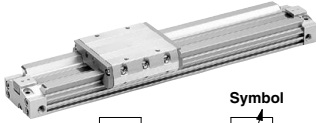

Bore size (mm)	16	25	40	63
Fluid	Air			
Action	Double acting			
Operating pressure range	0.2 to 0.8 MPa		0.15 to 0.7 MPa	
Proof pressure	1.05 MPa			
Ambient and fluid temperature	5 to 60°C			
Cushion	Air cushion			
Lubrication	Not required (Non-lube)			
Stroke length tolerance	1000 mm or less ^{+1.8} / ₋₃ , From 1001 mm ^{+2.8} / ₋₈			
Port size (Rc, NPT, G)	M5 x 0.8	1/8	1/4	3/8



Made to Order: Individual Specifications
(For details, refer to page 1452.)

Symbol	Specifications
-X168	Helical insert thread

Made to Order

[Click here for details](#)

Symbol	Specifications
-XB11	Long stroke type
-XB22	Shock absorber soft type RJ series type

Piston Speed

Bore size (mm)	16	25	40	63
Without stroke adjustment unit	80 to 1000 mm/s			
Stroke adjustment unit (L and H unit)	80 to 1500 mm/s			
External shock absorber	80 to 1500 mm/s			

- * When the RB series is used, operate at a piston speed that will not exceed the absorption capacity of the air cushion and stroke adjustment unit.
- * Because of its structure, the fluctuation of this cylinder's operating speed is greater than rod type cylinders. For applications that require constant speed, select an applicable equipment for the level of demand.

Stroke Adjustment Unit Specifications

Bore size (mm)		16				25				40				63			
Unit symbol		L		H		L		H		L		H		L		H	
Shock absorber model		RB0806		RB1007		RB1007		RB1412		RB1412		RB2015		RB2015		RB2725	
Shock absorber soft type RJ series (-XB22) model		RJ0806H		RJ1007H		RJ1007H		RJ1412H		RJ1412H		—		—		—	
Stroke adjustment range by intermediate fixing spacer (mm)		Without spacer		0 to -10		0 to -12		0 to -16		0 to -24		0 to -24		0 to -24		0 to -24	
		With short spacer		-10 to -20		-12 to -24		-16 to -32		-24 to -48		-24 to -48		-24 to -48		-24 to -48	
		With long spacer		-20 to -30		-24 to -36		-32 to -48		-48 to -72		-48 to -72		-48 to -72		-48 to -72	

* Stroke adjustment range is applicable for one side when mounted on a cylinder.

Stroke Adjustment Unit Symbol

		Right side stroke adjustment unit																
		Without unit					L: With low load shock absorber + Adjustment bolt					H: With high load shock absorber + Adjustment bolt						
				With short spacer		With long spacer				With short spacer		With long spacer						
Left side stroke adjustment unit	Without unit	Nil	SL	SL6	SL7	SH	SH6	SH7										
	L: With low load shock absorber + Adjustment bolt	With short spacer	L6S	L6L	L6	L6L7	L6H	L6H6	L6H7									
		With long spacer	L7S	L7L	L7L6	L7	L7H	L7H6	L7H7									
	H: With high load shock absorber + Adjustment bolt	With short spacer	H6S	H6L	H6L6	H6L7	H6H	H6H6	H6H7									
		With long spacer	H7S	H7L	H7L6	H7L7	H7H	H7H6	H7									

* Spacers are used to fix the stroke adjustment unit at an intermediate stroke position.

Stroke adjustment unit mounting diagram

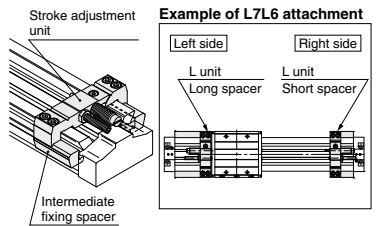

Shock Absorber Specifications

Type	RB 0806	RB 1007	RB 1412	RB 2015	RB 2725	
Max. energy absorption (J)	2.9	5.9	19.6	58.8	147	
Stroke absorption (mm)	6	7	12	15	25	
Max. collision speed (mm/s)	1500					
Max. operating frequency (cycle/min)	80	70	45	25	10	
Spring force (N)	Extended	1.96	4.22	6.86	8.34	8.83
	Compressed	4.22	6.86	15.98	20.50	20.01
Operating temperature range (°C)	5 to 60					

Note) The shock absorber service life is different from that of the MY3M cylinders depending on operating conditions. Allowable operating cycle under the specifications set in this catalog is shown below.

- 1.2 million times RB08□□□
- 2 million times RB10□□□ to RB2725

Note) Specified service life (suitable replacement period) is the value at room temperature (20 to 25°C). The period may vary depending on the temperature and other conditions. In some cases the absorber may need to be replaced before the allowable operating cycle above.

MY1B

MY1H

MY1B

MY1M

MY1C

MY1H

MY1 HT

MY1 □W

MY2C

MY2 H/HT

MY3A

MY3B

MY3M

D-□

-X□

Technical Data

MY3M Series

Theoretical Output

Bore size (mm)	Piston area (mm ²)	Operating pressure (MPa)						
		0.2	0.3	0.4	0.5	0.6	0.7	0.8
16	200	40	60	80	100	120	140	160
25	490	98	147	196	245	294	343	392
40	1256	251	377	502	628	754	879	1005
63	3115	623	934	1246	1557	1869	2180	2492

Note) Theoretical output (N) = Pressure (MPa) x Piston area (mm²)

Weight

Model	Bore size (mm)	Basic weight	Additional weight per 50 mm stroke	Weight of moving parts	Stroke adjustment unit weight (per unit)	
					L unit weight	H unit weight
					Unit: kg	
MY3M	16	0.29	0.08	0.13	0.05	0.06
	25	0.90	0.15	0.35	0.12	0.17
	40	3.03	0.31	1.14	0.34	0.43
	63	8.63	0.68	2.96	0.69	0.91

Calculation method/Example: **MY3M25-400H**

Basic weight 0.90 kg Cylinder stroke 400 st

Additional weight 0.15/50 st

H unit weight 0.17 kg

$0.90 + 0.15 \times 400 \div 50 + 0.17 \times 2 = 2.44$ kg

Option

Stroke Adjustment Unit Part No.

MY3M-A 25 L2 - 6N

Stroke adjustment unit

Bore size

16	16 mm
25	25 mm
40	40 mm
63	63 mm

Intermediate fixing spacer

Nil	Without spacer
6	Short spacer
7	Long spacer

Spacer delivery type

Nil	Unit installed
N	Spacer only

Unit no.

Symbol	Stroke adjustment unit	Mounting position
L1	L unit	Left
L2		Right
H1	H unit	Left
H2		Right

Note) Refer to page 1430 for details about adjustment range.

Component Parts

<p>MY3M-A25L1 (Without spacer)</p>	<p>MY3M-A25L1-6 (With short spacer)</p>	<p>MY3M-A25L1-7 (With long spacer)</p>	<p>MY3M-A25L1-6N (Short spacer only)</p>
			<p>MY3M-A25L1-7N (Long spacer only)</p>

Construction

MY3M

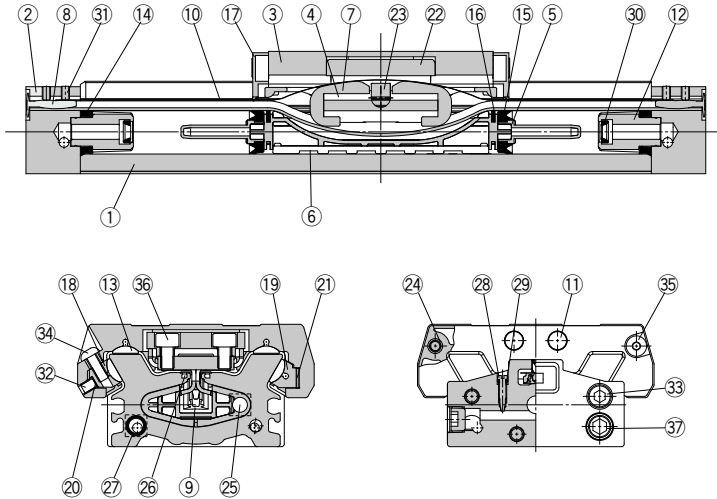

Component Parts

No.	Description	Material	Note
1	Cylinder tube	Aluminum alloy	Hard anodized
2	Head cover	Aluminum alloy	Hard anodized
3	Slide table	Aluminum alloy	Hard anodized
4	Piston yoke	Stainless steel	
5	Piston	Polyamide	
6	Wear ring	Polyacetal	
7	Belt separator	Polyacetal	
8	Belt clamp	Polybutylene terephthalate	
11	Stopper	Carbon steel	Nickel plated
12	Cushion boss	Aluminum alloy	Chromated
13	Bearing	Polyacetal	
16	Inner wiper	Special resin	
17	End cover	Polyamide	
18	Adjust arm A	Aluminum alloy	Chromated
19	Adjust arm B	Aluminum alloy	Chromated

No.	Description	Material	Note
20	Backup spring	Stainless steel	
21	Bearing adjustment rubber	NBR	
22	Coupler body	Aluminum alloy	Hard anodized
23	Coupler pin	Carbon steel	Electroless nickel plated
24	Spacer	Stainless steel	
25	Magnet	—	
26	Seal magnet	Rubber magnet	
28	Cushion needle	Rolled steel	Nickel plated
31	Hexagon socket head set screw	Chrome molybdenum steel	Chromated
32	Hexagon socket head set screw	Chrome molybdenum steel	Chromated
33	Hexagon socket head cap screw	Chrome molybdenum steel	Chromated
34	Hexagon socket button head screw	Chrome molybdenum steel	Chromated
35	Hexagon socket button head screw	Chrome molybdenum steel	Chromated
36	Hexagon socket head cap screw	Chrome molybdenum steel	Chromated
37	Hexagon socket head plug	Carbon steel	Chromated

Replacement Parts/Seal

No.	Description	Material	Qty.	MY3M16	MY3M25	MY3M40	MY3M63
9	Seal belt	Urethane Polyamide	1	MY3B16-16C-[Stroke]	MY3B25-16C-[Stroke]	MY3B40-16C-[Stroke]	MY3B63-16A-[Stroke]
10	Dust seal band	Stainless steel	1	MY3B16-16B-[Stroke]	MY3B25-16B-[Stroke]	MY3B40-16B-[Stroke]	MY3B63-16B-[Stroke]
29	O-ring	NBR	2	KA00309 (ø4 x ø1.8 x ø1.1)	KA00309 (ø4 x ø1.8 x ø1.1)	KA00320 (ø7.15 x ø3.75 x ø1.7)	KA00402 (ø8.3 x ø4.5 x ø1.9)
14	Tube gasket	NBR	2	MY3B16-PS	MY3B25-PS	MY3B40-PS	MY3B63-PS
15	Piston seal	NBR	2				
27	O-ring	NBR	4				
30	Cushion seal	NBR	2				

* Seal kit includes (14, 15, 27) and 30. Order the seal kit based on each bore size.

* Seal kit includes a grease pack (10 g).

When (9) and (10) are shipped as single units, a grease pack is included (10 g per 1000 strokes). Order with the following part number when only the grease pack is needed.

Grease pack part number: GR-S-010 (10 g), GR-S-020 (20 g)

* For instructions on how to replace replacement parts/seals, refer to the operation manual.

MY1B

MY1H

MY1B

MY1M

MY1C

MY1H

MY1 HT

MY1 □W

MY2C

MY2 H/HT

MY3A

MY3B

MY3M

D-□

-X□

Technical Data

MY3M Series

Slide Bearing Guide Type: $\varnothing 16$, $\varnothing 25$, $\varnothing 40$, $\varnothing 63$

MY3M Bore size — Stroke

* Refer to "Specific Product Precautions" on page 1453 for mounting.

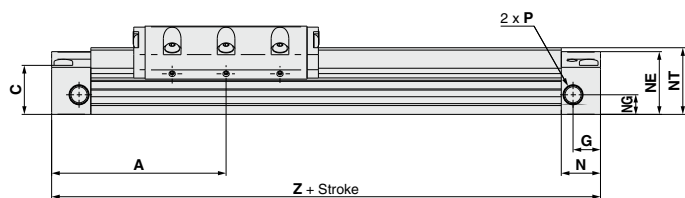
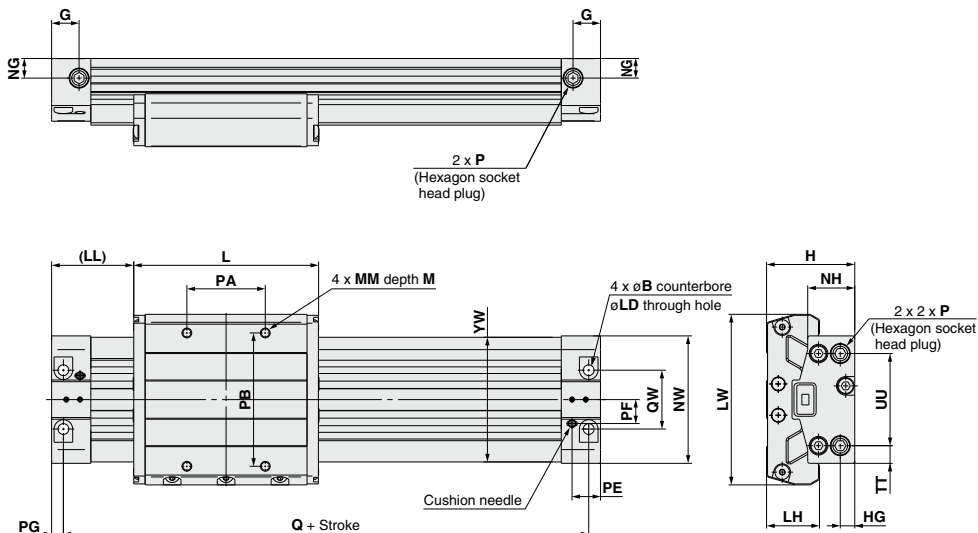

Port Variation

* Head cover piping connection can be freely selected to best suit different piping conditions.

← L → R →
Slide table operating direction

Model	A	B	C	G	H	HG	L	LD	LH	LL	LW	M	MM	N	NE	NG
MY3M16	61	6	18	9.5	33	5	65	3.5	20.5	28.5	64	6	M4 x 0.7	13.5	22.5	8
MY3M25	89	9.5	25	14	45	7.4	95	5.5	27	41.5	87	10	M5 x 0.8	20	32	10
MY3M40	138	14	38	18	63	12	160	8.6	35	58	124	13	M6 x 1.0	27	46	15
MY3M63	178	17	60	20.5	93	16.5	220	11	46	68	176	15	M10 x 1.5	31	70	29

Model	NH	NT	NW	P	PA	PB	PE	PF	PG	Q	QW	TT	UU	YW	Z
MY3M16	17.2	24	43	M5 x 0.8	28	48	9.7	8.5	4	114	19	6.5	30	44.6	122
MY3M25	24	34	65	Rc, NPT, G1/8	40	68	14.5	12.2	6	166	30	9	47	63.6	178
MY3M40	37	49	94	Rc, NPT, G1/4	100	100	19.5	16.5	8.5	259	40	14	66	93.6	276
MY3M63	58	76	139	Rc, NPT, G3/8	130	150	23.5	27.5	10	336	64	20	99	138	356

Slide Bearing Guide Type: $\varnothing 16$, $\varnothing 25$, $\varnothing 40$, $\varnothing 63$

Stroke adjustment unit

Low load shock absorber + Adjustment bolt

MY3M Bore size – Stroke L

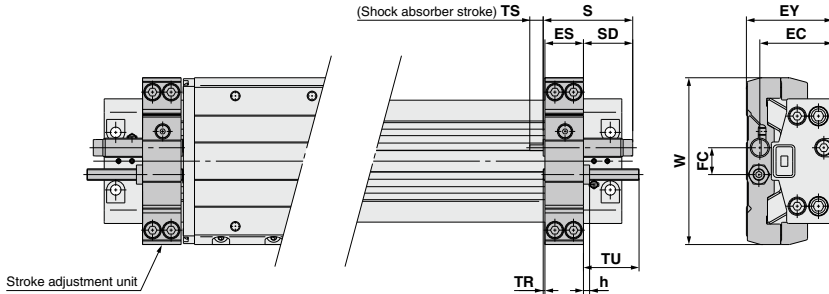

(mm)

Applicable cylinder	ES	EC	EY	FC	h	S	SD	TS	TR	TU	W	Shock absorber model
MY3M16	14.1	27.5	32.5	9	2.4	40.8	25.8	6	0.9	25	64	RB0806
MY3M25	20.1	38	44.5	14	3.6	46.7	25.2	7	1.4	28.5	87	RB1007
MY3M40	30.1	54	62.5	24	5	67.3	36.3	12	0.9	39	124	RB1412
MY3M63	36.1	81	92.5	32	6	73.2	36.2	15	0.9	43	176	RB2015

Note) When the stroke adjustment unit is used, the fitting type, which can be connected with the port on the body front and the back, will be limited. Refer to page 1411 for details.

Heavy-loaded shock absorber + Adjustment bolt

MY3M Bore size – Stroke H

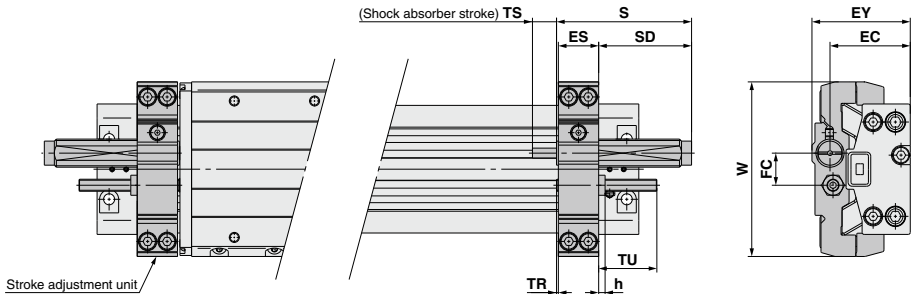

(mm)

Applicable cylinder	ES	EC	EY	FC	h	S	SD	TS	TR	TU	W	Shock absorber model
MY3M16	14.1	28.5	34.5	11	2.4	46.7	31.7	7	0.9	25	64	RB1007
MY3M25	20.1	40	49	16	3.6	67.3	45.8	12	1.4	28.5	87	RB1412
MY3M40	30.1	57	69	26	5	73.2	42.2	15	0.9	39	124	RB2015
MY3M63	36.1	84.5	100	32	6	99	62	25	0.9	43	176	RB2725

Note) When the stroke adjustment unit is used, the fitting type, which can be connected with the port on the body front and the back, will be limited. Refer to page 1411 for details.

MY1B

MY1H

MY1B

MY1M

MY1C

MY1H

MY1 HT

MY1 W

MY2C

MY2 H/HT

MY3A

MY3B

MY3M

D-□

-X□

Technical Data

MY3M Series

Side Support

Side support A MY-S□A

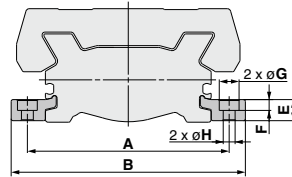
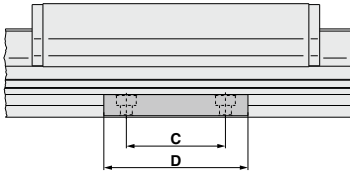

Side support B MY-S□B

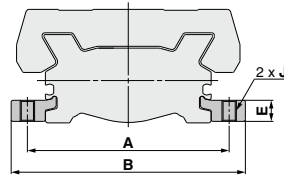
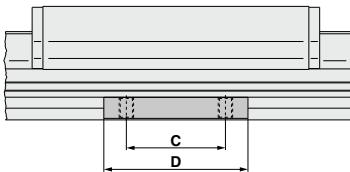

Model	Applicable cylinder	A	B	C	D	E	F	G	H	J
MY-S16 ^A _B	MY3M16	53	63.6	15	26	4.9	3	6.5	3.4	M4 x 0.7
MY-S25 ^A _B	MY3M25	77	91	35	50	8	5	9.5	5.5	M6 x 1
MY-S32 ^A _B	MY3M40	112	130	45	64	11.7	6	11	6.6	M8 x 1.25
MY-S50 ^A _B	MY3M63	160	182	55	80	14.8	8.5	14	9	M10 x 1.5

Note) A set of side supports consists of a left support and a right support.

Guide for Using Side Support

For long stroke operation, the cylinder tube may be deflected depending on its own weight and the load weight. In such a case, use a side support in the middle section. The spacing (L) of the support must be no more than the values shown in the graph on the right.

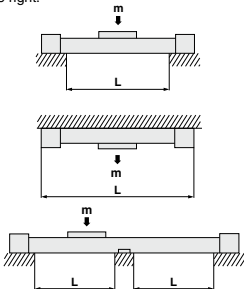

Guide for Using MY3M Side Support

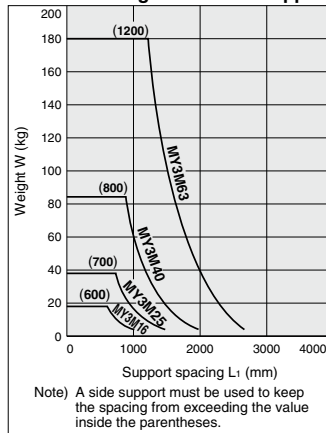

Note) A side support must be used to keep the spacing from exceeding the value inside the parentheses.

Caution

- ① If the cylinder mounting surfaces are not measured accurately, using a side support may cause poor operation. Therefore, be sure to level the cylinder tube when mounting. Also, for long stroke operation involving vibration and impact, use of a side support is recommended even if the spacing value is within the allowable limits shown in the graph.
- ② Support brackets are not for mounting; use them solely for providing support.

MY3 Series

Auto Switch Specifications

Auto Switch Proper Mounting Position (at Stroke End Detection)

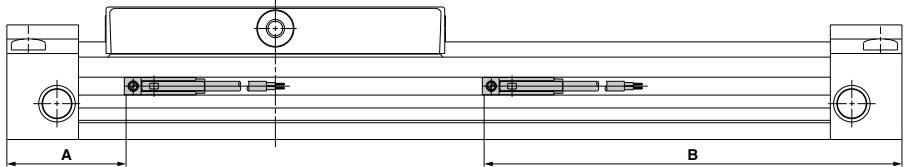

Auto Switch Proper Mounting Position

MY3A

Bore size	D-M9□ D-M9□V D-M9□W D-M9□WV D-M9□A D-M9□AV		D-A9□ D-A9□V	
	A	B	A	B
16	26	84	22	88
20	26	102	22	106
25	33	117	29	121
32	40.5	152.5	36.5	156.5
40	46.5	193.5	42.5	197.5
50	47	227	43	231
63	57.5	262.5	53.5	266.5

Note) The values in the table indicate the position of the auto switch's front end. Adjust the auto switch after confirming the operating conditions in the actual setting.

MY3B/MY3M

Bore size	D-M9□ D-M9□V D-M9□W D-M9□WV D-M9□A D-M9□AV		D-A9□ D-A9□V	
	A	B	A	B
16	32	90	28	94
20	36	112	32	116
25	47	131	43	135
32	56.5	168.5	52.5	172.5
40	64.5	211.5	60.5	215.5
50	65	245	61	249
63	75.5	280.5	71.5	284.5

Operating Range

Auto switch model	Bore size (mm)						
	16	20	25	32	40	50	63
D-M9□/M9□V D-M9□W/M9□WV D-M9□A/M9□AV	3.5	5	6	6.5	8	8	8
D-A9□/A9□V	6.5	9.5	10.5	12	15	13.5	14

* Since the operating range is provided as a guideline including hysteresis, it cannot be guaranteed. (Assuming approximately ±30% dispersion.) It may vary substantially depending on an ambient environment.

Auto Switch Mounting

When mounting an auto switch, first hold the switch spacer with your fingers and push it into the groove. Confirm that it is aligned evenly within the groove and adjust the position if necessary. Then, insert the auto switch into the groove and slide it into the spacer.

After deciding on the mounting position within the groove, slip in the mounting screw, which is included, and tighten it, using a flat head watchmaker's screw driver.

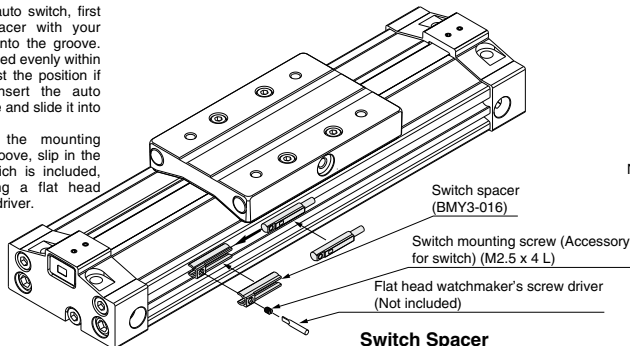

Note) Use a watchmaker's screw driver with a handle diameter of 5 to 6 mm to fasten the auto switch mounting screws. The tightening torque should be approximately 0.1 to 0.15 N·m. The guideline is a 90° rotation after the fastening is felt.

Switch Spacer

Applicable bore size (mm)	16	20	25	32	40	50	63
Switch spacer	BMY3-016						

Besides the models listed in How to Order, the following auto switches are applicable.

- * For solid state auto switches, auto switches with a pre-wired connector are also available. Refer to pages 1648 and 1649 for details.
- * Normally closed (NC = b contact) solid state auto switches (D-F9G/F9H types) are also available. Refer to page 1593 for details.

MY1B

MY1H

MY1B

MY1M

MY1C

MY1H

MY1 HT

MY1 □W

MY2C

MY2 H/HT

MY3A

MY3B

MY3M

D-□

-X□

Technical Data



1 Helical Insert Threads

-X168

The mounting threads of the slider are changed to helical insert threads.
The thread size is the same as standard.

MY3 **B** Bore size - Stroke - Auto switch Symbol - X168

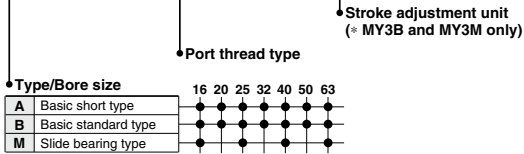

Example) MY3B16-300L-M9B-X168



MY3 Series

Specific Product Precautions

Be sure to read this before handling the products.

Refer to back page 50 for Safety Instructions and pages 3 to 12 for Actuator and Auto Switch Precautions.

Selection

⚠ Warning

1. When applying a load directly, set the design so that all the mounting threads on the slide table's upper surface are used.

Parts have been made smaller to achieve a compact size. If only some of the threads are used when mounting the load, the impact that results from the operation may cause extremely concentrated stress or disfiguration and may negatively affect operation. In worst cases the cylinder may be damaged, so please be careful.

⚠ Caution

1. Provide intermediate supports for long stroke cylinders.

Provide intermediate supports for cylinders with long strokes to prevent rod damage due to sagging of the rod, deflection of the tube, vibration and external loads. For detailed information, please refer to "Guide for Using Side Support" on pages 1434 and 1450.

2. For intermediate stops, use a dual-side pressure control circuit.

Since the mechanically jointed rodless cylinders have a unique seal structure, slight external leakage may occur. Controlling intermediate stops with a 3 position valve cannot hold the stopping position of the slide table (slider). The speed at the restarting state also may not be controllable. Use the dual-side pressure control circuit with a PAB-connected 3 position valve for intermediate stops.

3. Cautions on less frequent operation

When the cylinder is used extremely infrequently, operation may be interrupted in order for anchoring and a change lubrication to be performed or service life may be reduced.

Mounting

⚠ Caution

1. At each end of the cylinder, secure a mounting surface with a 5 mm or longer area that contacts the lower side of the cylinder.

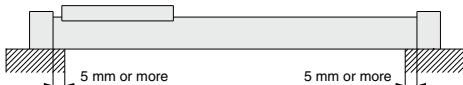

2. If the cylinder is mounted on the ceiling or wall under the condition where high load factors or impacts are expected, use side supports, in addition to the fixing bolts on the head cover, to support both ends of the cylinder tube.

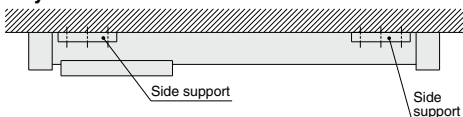

Mounting

⚠ Caution

3. Do not mount a slide table on the fixed equipment surface.

It may cause damage or malfunctions since an excessive load is applied to the bearing.

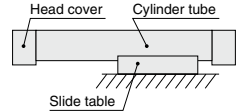

4. Consult with SMC when mounting in a cantilevered way.

Since the cylinder body deflects, it may cause malfunctions. Please consult with SMC when using it this way.

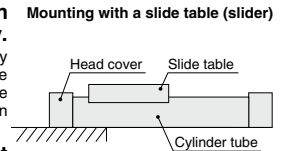

5. Do not mount cylinders as they are twisted.

When mounting, be sure for a cylinder tube not to be twisted. The flatness of the mounting surface is not appropriate, the cylinder tube is twisted, which may cause air leakage due to the detachment of a seal belt, damage a dust seal band, and cause malfunctions.

6. Do not generate negative pressure in the cylinder tube.

Take precautions under operating conditions in which negative pressure is generated inside the cylinder by external forces or inertial forces. Air leakage may occur due to separation of the seal belt. Do not generate negative pressure in the cylinder by forcibly moving it with an external force during the trial operation or dropping it with self-weight under the non-pressure state, etc. When the negative pressure is generated, slowly move the cylinder by hand and move the stroke back and forth. (When using with a stroke adjustment unit, please either remove the unit or adjust the stroke to the full stroke.) After doing so, if air leakage still occurs, please consult with SMC.

Operating Environment

⚠ Warning

1. Avoid use in environments where a cylinder will come in contact with coolants, cutting oil, droplet of water, adhesive matter, or dust, etc. Also avoid operation with compressed air that contains drainage or foreign matter, etc.

Foreign matter or liquids on the cylinder's interior or exterior can wash out the lubricating grease, which can lead to deterioration and damage of dust seal band and seal materials, causing a danger of malfunction.

When operating in locations with exposure to water and oil drops, or in dusty locations, provide protection such as a cover to prevent direct contact with the cylinder, or mount so that the dust seal band surface faces downward, and operate with clean compressed air.

2. The product is not designed for clean room usage.

If clean room usage is considered, please consult with SMC.

MY1B

MY1H

MY1B

MY1M

MY1C

MY1H

MY1 HT

MY1 W

MY2C

MY2 H/HT

MY3A

MY3B

MY3M

D-□

-X□

Technical Data