



[Connectors >](#) [Automotive Connectors >](#) [Automotive Connector Accessories >](#) [Other Automotive Connector Accessories >](#)

[AMPSEAL 16 Connectors Mounting Clips](#)



Automotive Connector Accessory Type: **Mounting Clip**

Primary Product Material: **PA**

Primary Product Color: **Black**

Operating Temperature Range: **-40 – 120 °C [-40 – 248 °F]**

[All AMPSEAL 16 Connectors Mounting Clips \(3\)](#)

## Features

### Product Type Features

Automotive Connector Accessory Type	Mounting Clip
-------------------------------------	---------------

### Body Features

Primary Product Material	PA
Primary Product Color	Black

### Usage Conditions

Operating Temperature Range	-40 – 120 °C[-40 – 248 °F]
-----------------------------	----------------------------

### Industry Standards

UL Flammability Rating	UL 94HB
------------------------	---------

### Packaging Features

Packaging Quantity	1
Packaging Method	Package

### Other

Serviceable	Yes
-------------	-----

## Product Compliance

[For compliance documentation, visit the product page on TE.com>](#)



EU RoHS Directive 2011/65/EU	Compliant
EU ELV Directive 2000/53/EC	Compliant
China RoHS 2 Directive MIIT Order No 32, 2016	No Restricted Materials Above Threshold
EU REACH Regulation (EC) No. 1907/2006	Current ECHA Candidate List: JUNE 2022 (224) Candidate List Declared Against: JUNE 2022 (224) Does not contain REACH SVHC
Halogen Content	Low Halogen - Br, Cl, F, I < 900 ppm per homogenous material. Also BFR/CFR/PVC Free
Solder Process Capability	Not applicable for solder process capability

Product Compliance Disclaimer

This information is provided based on reasonable inquiry of our suppliers and represents our current actual knowledge based on the information they provided. This information is subject to change. The part numbers that TE has identified as EU RoHS compliant have a maximum concentration of 0.1% by weight in homogenous materials for lead, hexavalent chromium, mercury, PBB, PBDE, DBP, BBP, DEHP, DIBP, and 0.01% for cadmium, or qualify for an exemption to these limits as defined in the Annexes of Directive 2011/65/EU (RoHS2). Finished electrical and electronic equipment products will be CE marked as required by Directive 2011/65/EU. Components may not be CE marked. Additionally, the part numbers that TE has identified as EU ELV compliant have a maximum concentration of 0.1% by weight in homogenous materials for lead, hexavalent chromium, and mercury, and 0.01% for cadmium, or qualify for an exemption to these limits as defined in the Annexes of Directive 2000/53/EC (ELV). Regarding the REACH Regulation, the information TE provides on SVHC in articles for this part number is based on the latest European Chemicals Agency (ECHA) 'Guidance on requirements for substances in articles' posted at this URL: <https://echa.europa.eu/guidance-documents/guidance-on-reach>

## Compatible Parts



TE Part # CAT-D487-CH8172  
DEUTSCH DT Series Housings & Connectors



TE Part # CAT-AM7801-CH8172  
AMPSEAL 16 Housings



TE Part # CAT-D485-CH8172  
DEUTSCH DTM HOUSINGS



TE Part # CAT-D48-PCH8172  
DEUTSCH DTHD HOUSINGS



TE Part # CAT-D486-CH8172  
DEUTSCH DTP HOUSINGS



TE Part # DTM04-12PA-EE04  
REC, 12P, BLK, N, HIGH TEMP, A



TE Part # DTM04-08PC  
REC, 8P, GRN, N, C



TE Part # 2318967-1  
24POS,AMP MCP 2.8,REC HSG ASSY, SLD

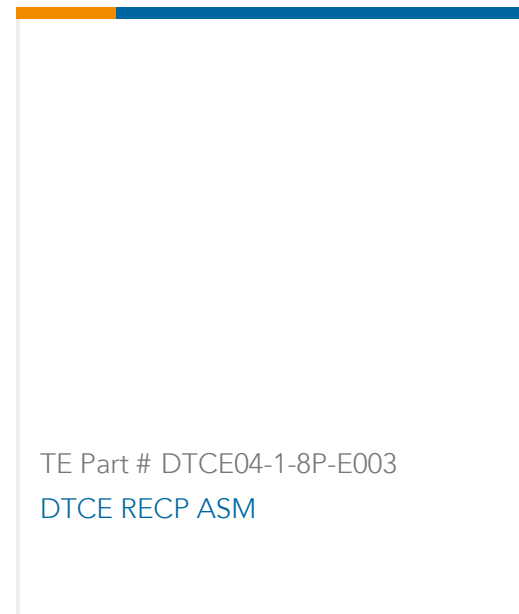
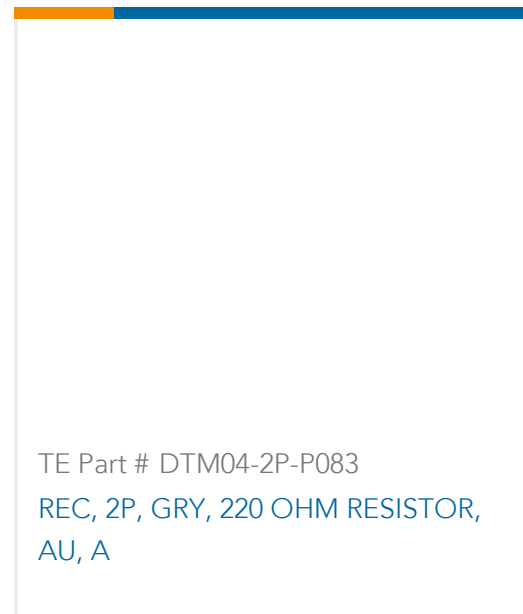

## Also in the Series | AMPSEAL 16

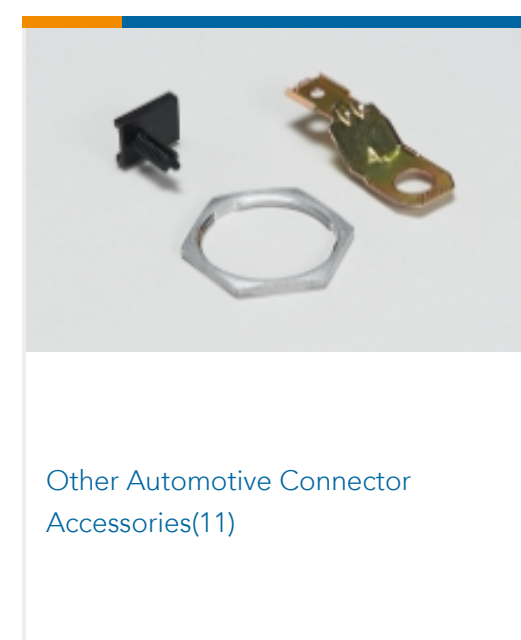
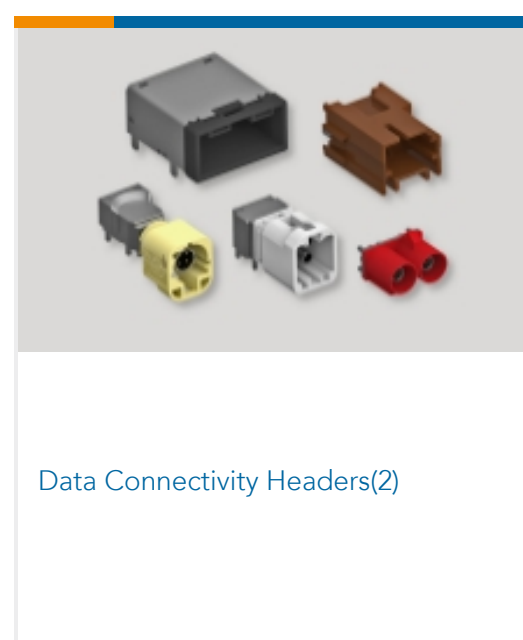
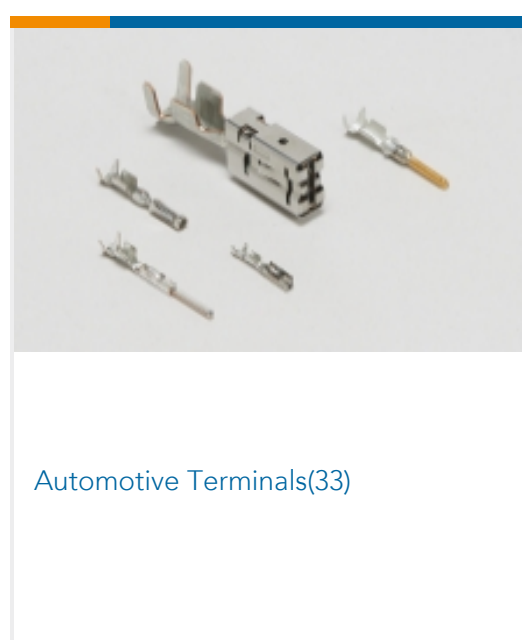
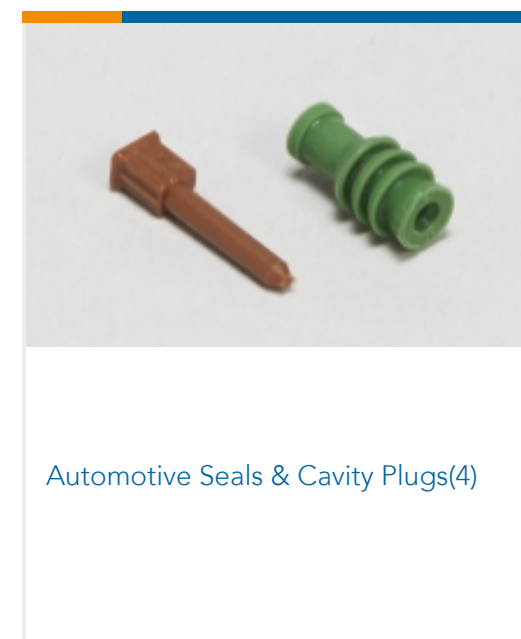
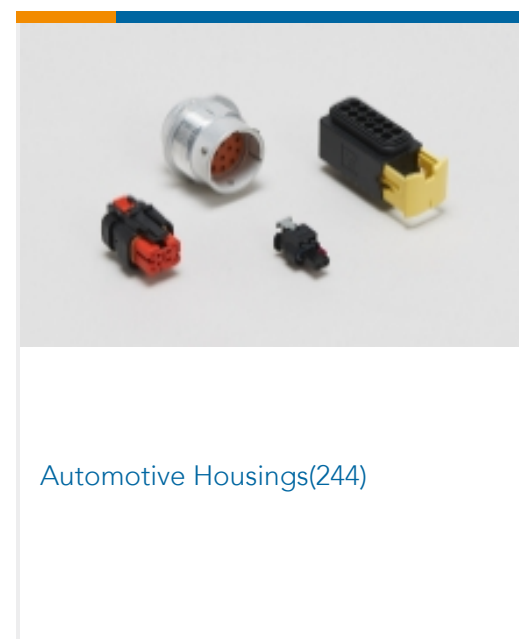
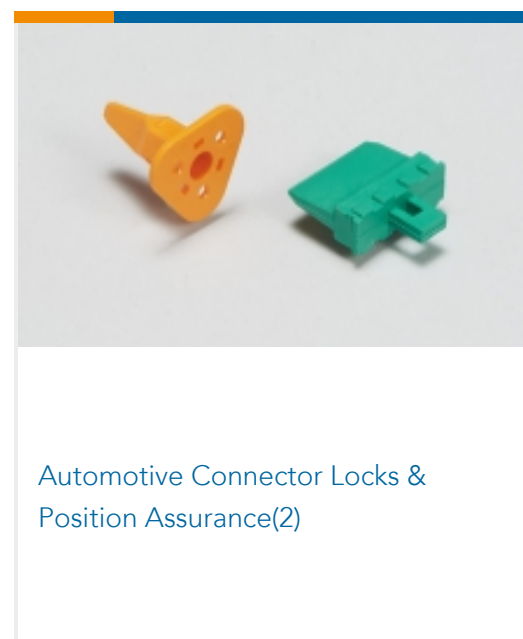
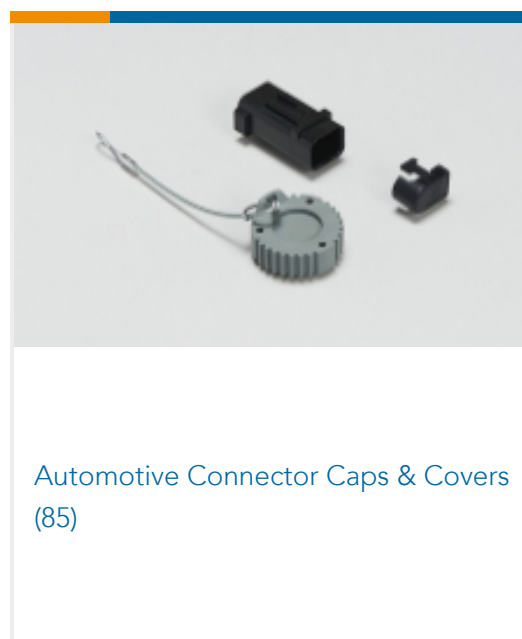

## Customers Also Bought

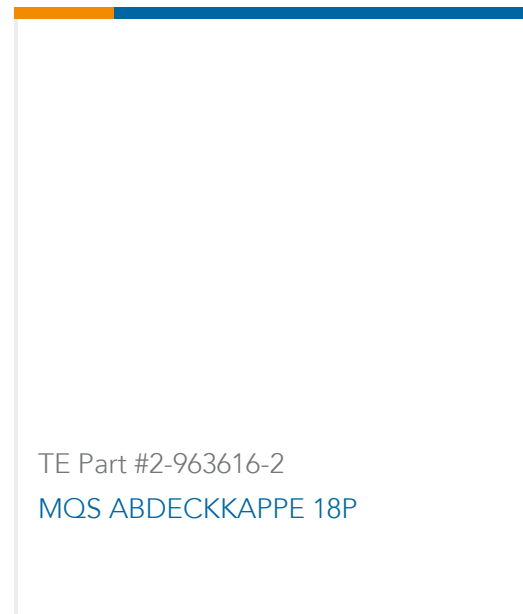
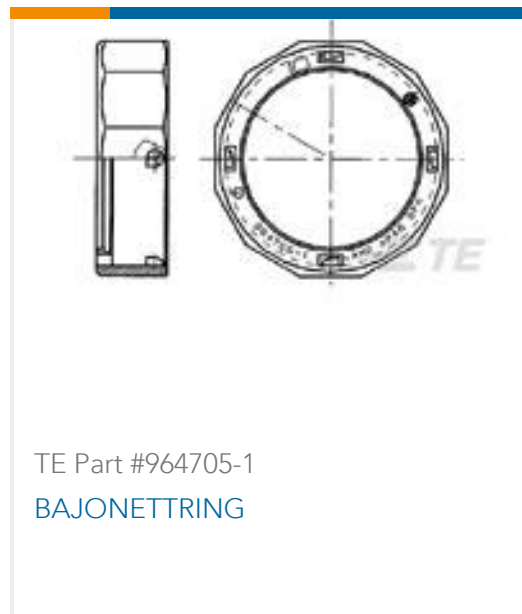
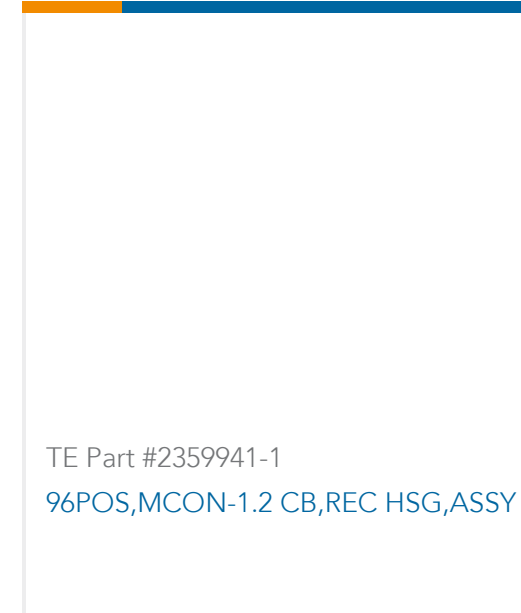

## Documents

### Product Drawings

#### MOUNTING CLIP, AMPSEAL 16

English

### CAD Files

#### 3D PDF

3D

#### Customer View Model

[ENG\\_CVM\\_CVM\\_1924487-2\\_D.2d\\_dxf.zip](#)

English

#### Customer View Model

[ENG\\_CVM\\_CVM\\_1924487-2\\_D.3d\\_igs.zip](#)

English

#### Customer View Model

[ENG\\_CVM\\_CVM\\_1924487-2\\_D.3d\\_stp.zip](#)

English

By downloading the CAD file I accept and agree to the [Terms and Conditions](#) of use.

### Datasheets & Catalog Pages





## CONNECTOR SELECTOR

English

---

### Product Specifications

#### Application Specification

English

---

### Instruction Sheets

#### Instruction Sheet (U.S.)

English