

# User Manual

# Anybus<sup>®</sup> Communicator CAN

# Modbus RTU

Doc.Id. HMSI-168-64  
Rev. 1.20



---

HALMSTAD • CHICAGO • KARLSRUHE • TOKYO • BEIJING • MILANO • MULHOUSE • COVENTRY • PUNE • COPENHAGEN

---

HMS Industrial Networks  
Mailing address: Box 4126, 300 04 Halmstad, Sweden  
Visiting address: Stationsgatan 37, Halmstad, Sweden

E-mail: [info@hms-networks.com](mailto:info@hms-networks.com)  
Web: [www.anybus.com](http://www.anybus.com)

---

# Important User Information

This document is intended to provide a good understanding of the functionality offered by the Anybus Communicator CAN - Modbus RTU.

The reader of this document is expected to be familiar with high level software design, and communication systems in general. The use of advanced Modbus RTU specific functionality may require in-depth knowledge of Modbus RTU networking internals and/or information from the official Modbus RTU specifications. In such cases, the people responsible for the implementation of this product should either obtain the Modbus RTU specification to gain sufficient knowledge or limit their implementation in such a way that this is not necessary. Also knowledge of CANopen (slave) is expected.

## Liability

Every care has been taken in the preparation of this manual. Please inform HMS Industrial Networks AB of any inaccuracies or omissions. The data and illustrations found in this document are not binding. We, HMS Industrial Networks AB, reserve the right to modify our products in line with our policy of continuous product development. The information in this document is subject to change without notice and should not be considered as a commitment by HMS Industrial Networks AB. HMS Industrial Networks AB assumes no responsibility for any errors that may appear in this document.

There are many applications of this product. Those responsible for the use of this device must ensure that all the necessary steps have been taken to verify that the applications meet all performance and safety requirements including any applicable laws, regulations, codes, and standards.

HMS Industrial Networks AB will under no circumstances assume liability or responsibility for any problems that may arise as a result from the use of undocumented features, timing, or functional side effects found outside the documented scope of this product. The effects caused by any direct or indirect use of such aspects of the product are undefined, and may include e.g. compatibility issues and stability issues.

The examples and illustrations in this document are included solely for illustrative purposes. Because of the many variables and requirements associated with any particular implementation, HMS Industrial Networks AB cannot assume responsibility for actual use based on these examples and illustrations.

## Intellectual Property Rights

HMS Industrial Networks AB has intellectual property rights relating to technology embodied in the product described in this document. These intellectual property rights may include patents and pending patent applications in the US and other countries.

The "Silk" icon set, used in the Anybus Configuration Manager tool, is created by Mark James, Birmingham, England. The complete icon set is found at <http://famfamfam.com/lab/icons/silk/>. The icon set is licensed under the Creative Commons Attribution 2.5 License (<http://creativecommons.org/licenses/by/2.5>).

## Trademark Acknowledgements

Anybus® is a registered trademark of HMS Industrial Networks AB. All other trademarks are the property of their respective holders.

**Warning:** This is a class A product. In a domestic environment this product may cause radio interference in which case the user may be required to take adequate measures.

**ESD Note:** This product contains ESD (Electrostatic Discharge) sensitive parts that may be damaged if ESD control procedures are not followed. Static control precautions are required when handling the product. Failure to observe this may cause damage to the product.

Anybus Communicator CAN - Modbus RTU User Manual

Rev 1.20

Copyright© HMS Industrial Networks AB

Nov 2013, Doc ID: HMSI-168-64

# Table of Contents

<b>Preface</b>	<b>About This Document</b>	
	Related Documents .....	1
	Document History .....	1
	Conventions & Terminology .....	2
	Sales and Support .....	3
 <b>Chapter 1</b>	 <b>About the Anybus Communicator CAN</b>	
	Introduction .....	4
	Anybus Communicator CAN Concept.....	5
	<i>General</i> .....	5
	<i>Data Exchange Model</i> .....	6
 <b>Chapter 2</b>	 <b>About the Module</b>	
	External view.....	7
	Mounting.....	8
	Status LEDs .....	9
	Connectors .....	10
	<i>Modbus RTU Connector</i> .....	10
	<i>Configuration Switches</i> .....	10
	<i>USB Connector</i> .....	12
	<i>CAN Connector</i> .....	12
	Power Connector.....	12
	Software Installation .....	13
	<i>Anybus Configuration Manager</i> .....	13
	<i>Firmware Update</i> .....	13

<b>Chapter 3</b>	<b>Getting Started</b>	
<b>Chapter 4</b>	<b>CAN Network Communication</b>	
	General.....	15
	Types of Messages.....	15
	<i>Query-Response</i> .....	15
	<i>Produce and Consume</i> .....	16
	Protocol Building Blocks.....	16
	Control/Status Word.....	18
	Transaction Live List.....	19
<b>Chapter 5</b>	<b>Configuration</b>	
	Configuring the Anybus Communicator CAN.....	20
	Configuring the Modbus RTU Network.....	20
<b>Chapter 6</b>	<b>Modbus RTU Communication</b>	
	General.....	21
	Data Representation.....	21
	<i>Memory Layout (Internal Memory Buffer)</i> .....	21
	<i>Supported Modbus Functions</i> .....	22
	<i>Modbus Exceptions</i> .....	22
	<i>Coil &amp; Register Map</i> .....	23
	<i>Modbus Diagnostics</i> .....	23
	<i>Network Termination</i> .....	24
<b>Chapter 7</b>	<b>Anybus Configuration Manager</b>	
	Main Window.....	25
	<i>Pull-down Menus</i> .....	26
<b>Chapter 8</b>	<b>Basic Settings</b>	
	Project.....	29
	Network Settings.....	29
	Communicator Settings.....	30
	Subnetwork Settings.....	31
<b>Chapter 9</b>	<b>Groups and Transactions</b>	
	General.....	32
	Groups.....	32
	Transactions.....	32
	<i>Produce</i> .....	33
	<i>Consume</i> .....	34
	<i>Query/Response</i> .....	35
	<i>Dynamic Produce</i> .....	36
	<i>Dynamic Consume</i> .....	37

---

**Chapter 10 Configuration of CAN Frames**

General.....	38
<i>CAN Identifiers</i> .....	38
Produce/Query CAN Frame.....	39
Consume/Response CAN Frame.....	39
CAN Frames in Dynamic Transactions.....	40

**Chapter 11 Online**

Select Connection.....	41
Connect/Disconnect .....	42
Download and Upload Configuration.....	42

**Chapter 12 Anybus Configuration Manager Tools**

Monitor/Modify .....	43
CAN Line Listener .....	44
Address Overview .....	45
Diagnostics/Status .....	46
Reassign Addresses .....	47
Project Summary .....	48
Password.....	49
Options .....	50

**Appendix A Technical Specification**

Protective Earth (PE) Requirements.....	51
Power Supply .....	51
Environmental Specification .....	51
<i>Temperature</i> .....	51
<i>Relative Humidity</i> .....	51
EMC (CE) Compliance .....	52

**Appendix B Configuration Example**

## P. About This Document

For more information, documentation etc., please visit the HMS website, ‘[www.anybus.com](http://www.anybus.com)’.

### P.1 Related Documents

Document	Author
CAN protocol specification	<a href="http://www.can-cia.org">www.can-cia.org</a>
Modbus Application Specification	Modbus-IDA
Modbus over serial line specification and implementation guide	Modbus.org

### P.2 Document History

#### Summary of Recent Changes (1.01 ... 1.20)

Change	Page(s)
Updated main window screenshot in chapter 7	25
Removed “cut”, “copy” and “paste” from the edit menu	26
Added parameter “Silence Time” to “Subnetwork Settings”	29
Added parameter “Produce Alias” to “Produce”	31
Added parameters “Consume Alias”, “Consistency Check”, “Transaction Status Byte” and Transaction Status Address” to “Consume”	35
Changed screenshots and added information in “Select Connection”	42, 43
Added new item “Reassign Addresses” under “Anybus Configuration Manager Tools”	48
Added information on byte order when storing the control/status word	17
Added dynamic transactions	15, 41, 37, 38
Added information on transaction status byte	35
Added new state to CAN subnetwork status LED	9

#### Revision List

Revision	Date	Author(s)	Chapter(s)	Description
1.00	2011-09-22	KeL	-	First official release
1.01	2012-02-13	KeL	12	Minor updates
1.10	2012-09-10	KaD, KeL	2, 4, 7, 8, 9, 10, 11, 12	Service pack 1 updates
1.20	2013-11-05	SDa	2	Updated node address example.

## P.3 Conventions & Terminology

The following conventions are used throughout this manual:

- Numbered lists provide sequential steps
- Bulleted lists provide information, not procedural steps
- The terms 'Anybus' or 'module' refers to the Anybus Communicator CAN module.
- The terms 'host' or 'host application' refers to the device that hosts the Anybus module.
- Hexadecimal values are written in the format NNNNh or 0xNNNN, where NNNN is the hexadecimal value.
- A byte always consists of 8 bits.

## P.4 Sales and Support

For contact information and where to find support, please refer to the contact and support pages at: [www.hms-networks.com](http://www.hms-networks.com).

# 1. About the Anybus Communicator CAN

## 1.1 Introduction

The Anybus Communicator CAN is a series of products that acts as a gateway between a subnetwork - running the standard CAN protocol - and a number of popular industrial networks. Integration of industrial devices is enabled with no loss of functionality, control or reliability, both when retro-fitting to existing equipment, as well as when setting up new installations.

The Anybus Communicator CAN is based on patented Anybus technology, a proven industrial communication solution used all over the world by leading manufacturers of industrial automation products. Each module offers integration of industrial CAN devices to one of these industrial networks:

EtherCAT	PROFIBUS
ControlNet	Modbus-RTU
Modbus-TCP	PROFINET
PROFINET IRT	EtherNet/IP
DeviceNet	CC-Link
CANopen.	

The scope of this manual is the Anybus Communicator CAN for **Modbus RTU**. The manual primarily describes the functionality and the configuration of the CAN network and the connection between the CAN network and the Modbus RTU network. Relevant information on the Modbus RTU interface of the module is given, with the intention to facilitate the configuration of the interface into a Modbus RTU network. For information about Modbus RTU, please refer to official specifications.

No proprietary configuration software is needed. All necessary configuration is performed using the tool **Anybus Configuration Manager**, which accompanies the product.

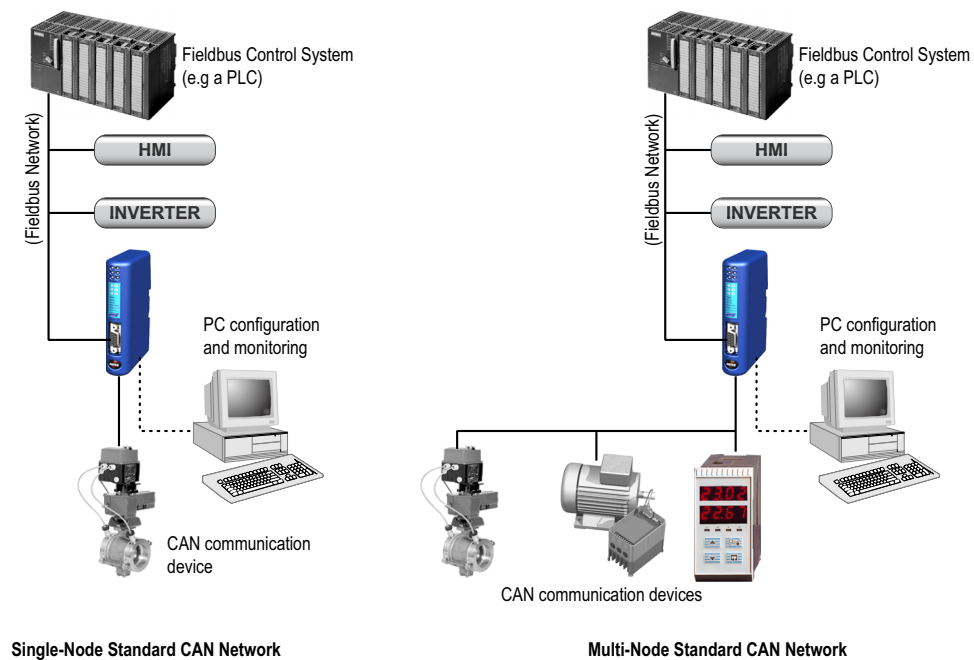



## Subnetwork

The Anybus Communicator CAN recognizes and supports communication that conforms to the CAN standards 2.0A and 2.0B. The Communicator can adapt to any pre-defined network using CAN frames as means for data exchange, using the Anybus Configuration Manager tool, which is included with the product.

- 0 - 8 bytes of data in each frame
- 11-bit (CAN 2.0A) identifier or 29-bit (CAN 2.0B) identifier
- Bit rates supported: 20, 50, 100, 125, 200, 250, 500, 800 and 1000 kbit/s.

## Modbus RTU Interface

Modbus RTU connectivity is provided through patented Anybus technology:

- Modbus-RTU compliant, passive slave node operation
- Variable baud rate 1200 - 57600 bit/s
- Up to 256 registers in each direction
- Modbus diagnostics
- RS485 or RS232 operation
- On-board configuration switches

# 1.2 Anybus Communicator CAN Concept

## 1.2.1 General

The Anybus Communicator is designed to exchange data between a subnetwork, running CAN, and a higher level network. The CAN protocol uses frames, that are individually configurable, offering great flexibility.

Through the configuration of the CAN frames, the Communicator will adapt to a predefined CAN network. It will be possible to send data to and receive data from the subnetwork, but also to act as a relay for data on the CAN subnetwork.

The Communicator can issue frames cyclically, on change of data, or based on trigger events issued by the control system of the higher level network (i.e. the fieldbus master or PLC) or by the CAN network. It can also monitor certain aspects of the sub-network communication and notify the higher level network when data has changed.

An essential part of the Anybus Communicator package is the Anybus Configuration Manager, a Windows™ application used to supply the Communicator with a description of the subnetwork protocol. No programming skills are required; instead, a visual protocol description system is used to specify the different parts of the CAN frames.

### 1.2.2 Data Exchange Model

Internally, the data exchanged on the subnetwork, and the data exchanged on the higher level network, resides in the same memory.

This means that in order to exchange data with the subnetwork, the higher level network simply reads and writes data to memory locations specified using the Anybus Configuration Manager. The very same memory locations can then be exchanged on the subnetwork.

The internal memory buffer is divided into three areas based on their function:

- **Input Data (Up to 256 registers)**  
This area can be read by the higher level network. Each register corresponds to two bytes.
- **Output Data (Up to 256 registers)**  
This area can be written to by the higher level network. Each register corresponds to two bytes.
- **General Data**

This area can not be accessed from the higher level network, but may be used for transfers between individual nodes on the subnetwork, or as a general “scratch pad” for data. The size of the General Data area is 1024 bytes. How much data of the area that is used for subnetwork communication is decided by the configuration.

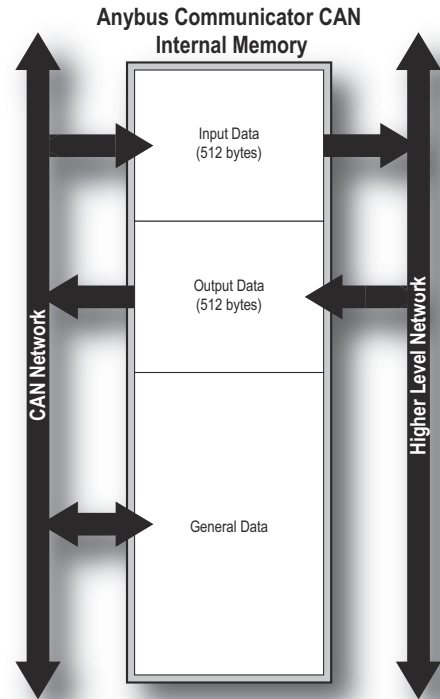

### Memory Map

When building the subnetwork configuration using the Anybus Configuration Manager, the different areas described above are mapped to the memory locations (addresses) specified below.

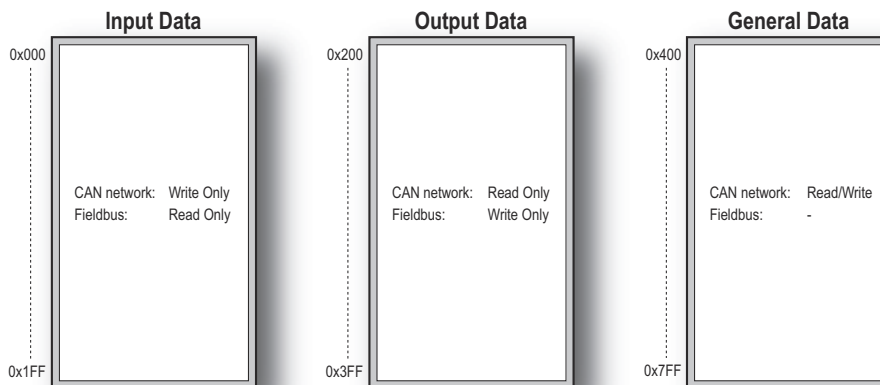

## 2. About the Module

### 2.1 External view

#### A: Status LEDs

See also...

- “Status LEDs” on page 9

#### B: Fieldbus Specific Connector and Switches

This connector and these switches are used to connect the Anybus Communicator CAN module to the Modbus RTU network. They are described in “Modbus RTU Connector” on page 10.

#### C: USB connector

This connector is used for uploading and downloading the configuration and for software upgrade of the module.

See also...

- “USB Connector” on page 12

#### D: CAN Connector

This connector is used to connect the communicator to the CAN network.

See also...

- “CAN Connector” on page 12

#### E: Power Connector

This connector is used to apply power to the communicator.

See also...

- “Power Connector” on page 12

#### F: DIN-rail Connector

The DIN-rail mechanism connects the communicator to PE (Protective Earth).

See also...

- “Mounting” on page 8

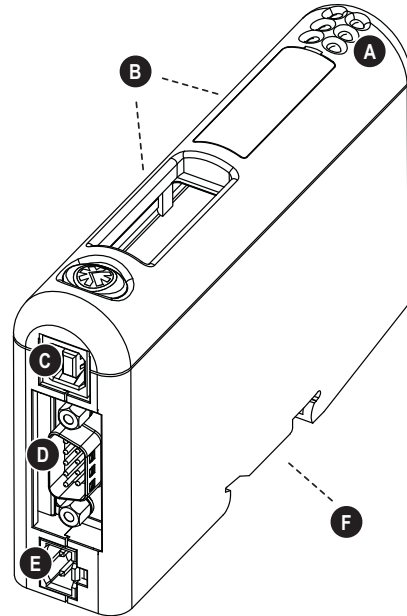

## 2.2 Mounting

Perform the following steps when physically installing the Communicator:

1. Snap the Communicator on to the DIN-rail (See “External view” on page 7).

The DIN-rail mechanism works as follows:

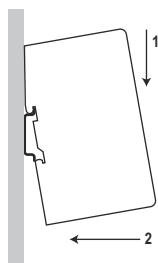

To snap the Communicator *on*, first press the it downwards (1) to compress the spring in the DIN-rail mechanism, then push it against the DIN-rail as to make it snap on (2).

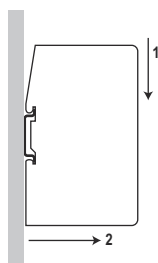

To snap the Communicator *off*, push the it downwards (1) and pull it out from the DIN-rail (2), as to make it snap off from the DIN-rail.

2. Connect the Communicator to the CAN network.
3. Connect the Communicator to the Modbus RTU network.
4. Set the Modbus RTU configuration switches
5. Connect the power cable and apply power.

## 2.3 Status LEDs

The status LEDs on the front indicate the status of the module as shown in the table below.

Status LEDs 1 - 4 indicate the status of the Modbus RTU network and status LEDs 5 - 6 indicate the status of the CAN subnetwork and the device.

#	State	Status
1 - Bus Error	Off	Normal operation
	Red	Bus error
2 - Bus Ready	Off	No power
	Green	Bus ready
	Red	Bus timeout error
3 - Processing	Off	No query is currently being processed
	Flashing green	Processing query
4 - HW settings status	Off	Using switch settings, normal operation
	Red	Not configured. Operating at 19200 bps. will only respond to broadcast messages.
5 - CAN subnetwork status	Off	Power off/no CAN communication
	Green	Running with no transaction error/timeout
	Flashing green	Not all transactions have been executed at least once since startup and no transaction error/timeout has occurred.
	Flashing red	Transaction error/timeout or subnetwork stopped
	Red	Fatal error
6 - Device status	Off	Power off
	Alternating red/green	Invalid or missing configuration
	Green	Operation mode Run
	Flashing green	Operation mode Idle
	Red	Fatal error

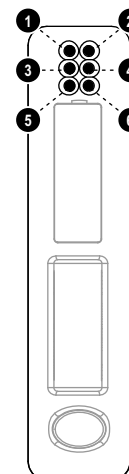

## 2.4 Connectors

### 2.4.1 Modbus RTU Connector

#	Signal	Meaning
1	-	Not connected
2	TxD	Transmit signal (RS-232)
3	RxD	Receive signal (RS-232)
4	-	Not connected
5	GND	Signal ground
6	+5 V	Power supply
7	B	RS485- (D0) (B-line)
8	A	RS485+ (D1) (A-line)
9	-	Not connected
Casing		P.E.

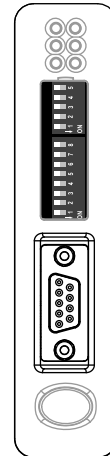
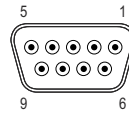

### 2.4.2 Configuration Switches

The Modbus RTU interface includes configuration switches for Node ID, baud rate, parity and physical interface.

**Note:** Normally the configuration switches are covered by a plastic hatch. When removing the hatch, avoid touching the circuit boards and components. If tools are used when opening the hatch, be careful.

#### Node Address

Each node on a Modbus RTU network must be assigned a unique node ID. Seven switches are used to set the Modbus node ID of the slave interface in binary form. The switches are read once during startup, i.e. the gateway must be restarted for any changes to take effect. The highest possible node address is 127.

Node Address	Sw. 1	Sw. 2	Sw. 3	Sw. 4	Sw. 5	Sw. 6	Sw. 7
(reserved)	OFF	OFF	OFF	OFF	OFF	OFF	OFF
1	OFF	OFF	OFF	OFF	OFF	OFF	ON
2	OFF	OFF	OFF	OFF	OFF	ON	OFF
...	...	...	...	...	...	...	...
126	ON	ON	ON	ON	ON	ON	OFF
127	ON	ON	ON	ON	ON	ON	ON

*Example:*

In this example, the Modbus node ID is set to 126.

Example Node Address: 126

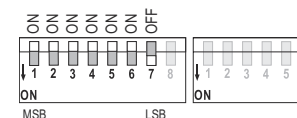

### Baud Rate Configuration

The standard baud rate of Modbus RTU is 19.2 kbit/s. The Slave interface does, however, allow baudrates from 1.2kbit/s to 57.6kbit/s to be selected via the baud rate switches. The switches are read once during startup, i.e. the gateway must be restarted for any changes to take effect.

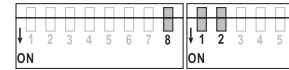

Switch 8	Switch 1	Switch 2	Baud rate (kbit/s)
OFF	OFF	OFF	-
OFF	OFF	ON	1.2
OFF	ON	OFF	2.4
OFF	ON	ON	4.8
ON	OFF	OFF	9.6
ON	OFF	ON	19.2
ON	ON	OFF	38.4
ON	ON	ON	57.6

*Example:*

In this example, the baudrate will be 1.2kbit/s.

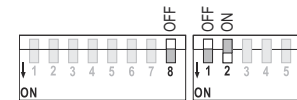

### Parity

The Modbus slave interface allows different parity settings to be selected via the parity switches. The switches are read once during startup, i.e. the gateway must be restarted for any changes to have effect.

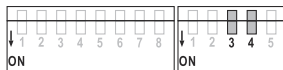

Switch 3	Switch 4	Parity	Stop bits
OFF	OFF	-	-
OFF	ON	None	2
ON	OFF	Even	1
ON	ON	Odd	1

*Example:*

2 stop bits, no parity (Modbus RTU standard)



### Physical Interface

The slave interface supports RS232 and RS485 communication standards

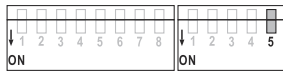

Switch 5	Type
OFF	RS485
ON	RS232

*Example:*

In this example, the physical interface is set to RS232

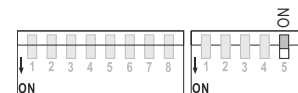

### 2.4.3 USB Connector

At the bottom of the module you find a USB connector used for software upgrade of the module and for uploading and downloading configurations.

Pin no.	Description
1	+5 V input
2	USBDM (USB communication signals)
3	USBDP (USB communication signals)
4	Signal GND
Housing	Cable Shield

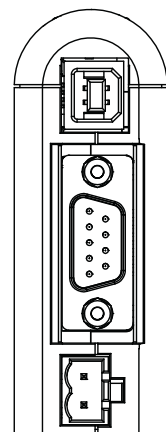
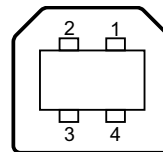

**Note:** USB is used for configuration and software upgrade only. Remove the USB cable when the configuration of the module is finished.

### 2.4.4 CAN Connector

The CAN connector is found next to the USB connector.

Pin no.	Description
2	CAN_L
5	Housing, CAN cable shield
7	CAN_H
1, 4, 8, 9	(not connected)
3, 6	CAN GND

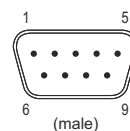



## 2.5 Power Connector

Pin no.	Description
1	+24V DC
2	GND



### Notes:

- Use 60/75 or 75×C copper (CU) wire only.
- The terminal tightening torque must be 5-7 lbs-in (0.5 - 0.8 Nm)

See also...

- “Power Supply” on page 52

---

## 2.6 Software Installation

### 2.6.1 Anybus Configuration Manager

#### System Requirements

- Pentium 233 MHz or higher (300 MHz recommended)
- 64 MB RAM or more (128 MB recommended)
- Microsoft Windows XP, Windows Vista, or Windows 7

#### Installation

- **Anybus Communicator CAN resource CD**  
Insert the CD and follow the onscreen instructions. If the installation does not start automatically right-click on the CD-drive icon and select Explore. Execute 'setup.exe' and follow the onscreen instructions.
- **From website**  
Download and execute the self-extracting .exe file from the HMS website ([www.anybus.com](http://www.anybus.com)).

### 2.6.2 Firmware Update

Updates of the Communicator firmware will be published on the support pages at [www.anybus.com](http://www.anybus.com). Also available is the tool Firmware Download TP, that is used to download the updated firmware to the Communicator.

**Note:** Before downloading the new firmware, save a copy of the configuration, as the configuration in the module will be erased during the installation process of the new firmware. When download of the firmware is finished, the configuration can be restored from the safety copy.

## 3. Getting Started

The purpose of this chapter is to give a short description of how to install the module and get it up and running, transferring I/O data between the CAN network and the Modbus RTU network. Before starting, make sure that you have access to knowledge about the CAN protocol to be configured, e.g. access to the CAN protocol specification.

Perform the following steps when installing the Communicator:

1. Download the Anybus Configuration Manager from the product pages at [www.anybus.com](http://www.anybus.com) or copy it from the CD that accompanies the product. Install it on your PC.
2. Build your configuration in the Anybus Configuration Manager tool, for an example see “Configuration Example” on page 54, for a description of the tool see chapters 7 to 12.
3. Connect the Communicator to your PC using the USB connector.
4. Connect the power cable and apply power.
5. Download the configuration from the Anybus Configuration Manager to the Communicator. See “Online” on page 42.
6. Remove the USB cable, turn off the power and disconnect the power cable.
7. Snap the Communicator on to the DIN-rail (See “Mounting” on page 8).
8. Connect the Communicator to the CAN network with proper termination and shielding.
9. If necessary, configure the other nodes in the CAN network.
10. Connect the Communicator to the Modbus RTU network.
11. Connect the power cable and apply power.
12. Configure the Modbus RTU network. Please adapt the configuration to the one stored in the Communicator.

## 4. CAN Network Communication

### 4.1 General

The CAN protocol is message-based and offers the possibility to exchange up to 8 bytes of data in each message. How these bytes are interpreted, is defined in each application. The CAN protocol is a transparent protocol, meaning that it only acts as a data carrier, and it is up to the users (the application) to define and interpret the data content of the messages.

Data on CAN is exchanged using frames. Each frame has a unique identifier for the data it exchanges. The identifier also represents the message priority on the CAN network. The Anybus Communicator CAN supports either 11-bit (CAN 2.0A) or 29-bit (CAN 2.0B) identifiers, depending on what is defined during configuration.

CAN is essentially a produce-consume network, where all nodes listen to all messages. The devices recognize what data to collect by what identifier the CAN frame carries. The Communicator is also able to act as a Master and issue queries that demand responses. It is possible to use both methods in the same configuration of the module.

### 4.2 Types of Messages

The Anybus Communicator CAN features three different message types regarding the subnetwork communication, called 'Query/Response', 'Produce' and 'Consume'. Note that these messages only specify the basic communication model, not the actual CAN protocol. All three types of messages can be used in the same configuration.

#### 4.2.1 Query-Response

The Communicator acts as a master on the subnetwork, and the CAN communication takes place in a query-response fashion. The Communicator sends a query and expects an answer within the specified timeout.

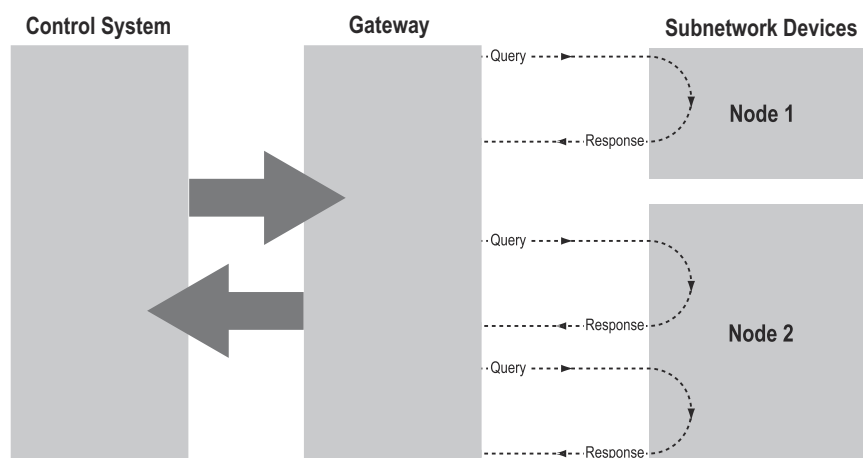

## 4.2.2 Produce and Consume

When using these messages, there is no master-slave relationship between the Communicator and the nodes on the subnetwork. Any node, including the Communicator, may spontaneously produce a message. The message is sent on the network. The nodes on the network listen to all traffic and decide independently which messages to consume (read). Nodes do not have to respond to messages, nor do they have to wait for a query to send a message on the network.

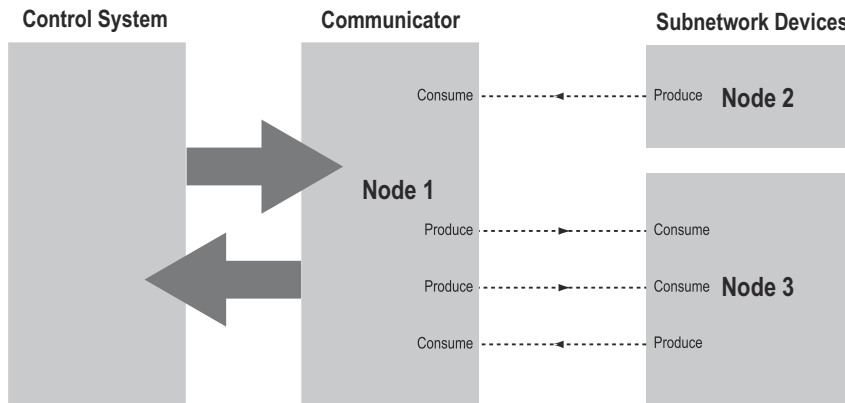

In the figure above, the Communicator 'consumes' data that is 'produced' by a node on the subnetwork. This 'consumed' data can then be accessed from the higher level network. This also works the other way around; the data received from the higher level network is used to 'produce' a message on the subnetwork to be 'consumed' by a node.

**Note:** When configuring the Communicator using the Anybus Configuration Manager, 'produce' and 'consume' are defined from the Communicator's perspective.

## 4.3 Protocol Building Blocks

The following building blocks are used in Anybus Configuration Manager to describe the subnetwork communication. How these blocks apply to the two modes of operation will be described later in this document.

- **Group**

A group in the Anybus Configuration Manager does not represent any special device on the CAN network. It is a means to structure the transactions that are defined for the Communicator. Each group can be associated with a number of transactions, see below.

- **Transaction**

A transaction consists of one or more CAN frames. Each transaction is associated with a set of parameters controlling how and when to use it on the subnetwork. There are five kinds of transactions: produce, consume, query-response, dynamic produce and dynamic consume. A group can contain transactions of all three types simultaneously. A total of 128 transactions can be configured.

- **Dynamic Transaction**

In normal transactions, all parameters are changed using the Anybus Configuration Manager. A dynamic transaction makes it possible for a network master to change selected parameters during runtime. The parameters are mapped to the output data area or to the general data area and it will not be possible to change them using the Anybus Configuration Manager. A dynamic trans-

action may only consist of one CAN frame that can hold up to one data object. Also only one produce and one consume dynamic transaction are allowed.

- **CAN Frames**

The CAN frames are low level entities used to compose transactions (see above). Each frame carries an 11-bit or 29-bit identifier and can hold up to 8 bytes of data. See “Configuration of CAN Frames” on page 39. A total of 256 CAN frames can be configured.

## 4.4 Control/Status Word

An optional control/status word can be used to control the startup mode of the module and to read the status of the CAN network. The control word is always mapped to the first two bytes of the output data area, and the status word is mapped to the first two bytes of the input data area. It is not possible to change these locations.

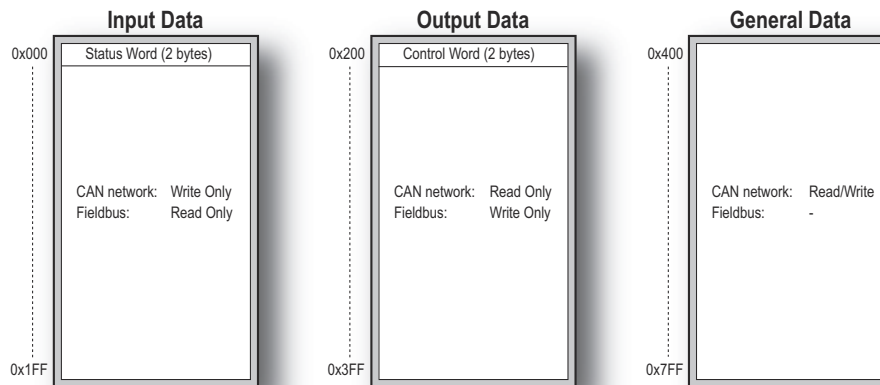

**Note 1:** The picture shows the maximum available data areas in the Communicator. Not all fieldbuses can access all addresses in the input and output data areas, please see section Data Exchange Model in chapter 1.

**Note 2:** The control/status words are stored in the first two bytes of the data areas, with the least significant byte (bit 0-7) in the first byte (byte #0).

Through the control word it is possible to reset the CAN controller, reboot the module and decide the start-up mode of the Communicator:

Bit	Name	Description
15 - 3	(Reserved)	
2	Reset CAN	A transition from 0 to 1 resets the CAN controller (used when the CAN interface is bus off).
1	Reboot module	A transition from 0 to 1 reboots the Communicator (software reset)
0	Operation mode	This bit sets the start-up operation mode of the Communicator: 0 - Idle (No new data issued to the CAN network. Data received from the CAN network is sent on the Modbus RTU network.) 1 - Run (Data is exchanged between the CAN network and Modbus RTU.)

The status word holds status information from the CAN network:

Bit	Name	Description
15 - 6	(Reserved)	
5	CAN overrun	0 - OK 1 - CAN reception overrun
4	Error passive	0 - The CAN interface is NOT in error passive state 1 - The CAN interface is in error passive state
3	Bus off	0 - Bus running 1 - Bus off
2	Reset CAN complete	If set, the CAN controller has been reset (used when the CAN interface is bus off).
1	(Reserved)	
0	Operation mode	0 - Idle 1 - Run

## 4.5 Transaction Live List

An optional transaction live list is available. It consists of a bit array where each bit corresponds to a transaction on the CAN subnetwork. (bit 0 corresponds to transaction 1 etc.). A set bit indicates normal functionality. The bit is not set if the transaction is non-working or non-existent. The live list is mapped in the input data area of the memory, either at the start of the area or directly after the status word. From 8 transactions up to 128 transactions in steps of 8 can be monitored using the live list. Thus, up to 16 bytes of the input data area of the memory can be occupied by the live list.

The latest live list is always available from the Anybus Configuration Managers Diagnostics/Status window, whether the live list is mapped in the input data area or not, see “Diagnostics/Status” on page 47.



## 5. Configuration

### 5.1 Configuring the Anybus Communicator CAN

The configuration of the Anybus Communicator CAN is performed using the configuration tool Anybus Configuration Manager for Communicator CAN (ACM). The tool is included on the CD that accompanies the module, and it is also available for download at [www.anybus.com](http://www.anybus.com). Chapters 7 to 12 in this manual describe the configuration tool and its features. A configuration example is given in Appendix B on page 54.

The USB connector at the bottom of the module is used for uploading and downloading the configuration. Please remove the USB cable when the configuration of the Communicator is finished.

### 5.2 Configuring the Modbus RTU Network

The Anybus Communicator CAN - Modbus RTU is a Modbus RTU slave/adaptor on the Modbus RTU network. The general settings for the adapter interface are configured using the ACM (see “Network Settings” on page 28). Please note that the size of the I/O data that can be read from and written to the module is defined when configuring the Communicator using the ACM tool.

There are a number of different configuration tools for Modbus RTU available on the market. The choice of tool depends on the application and the Modbus RTU master of the network.

An application note, describing how to configure an Anybus Modbus RTU slave interface, is available on the support pages for the Anybus Communicator CAN - Modbus RTU module at [www.anybus.com](http://www.anybus.com).

## 6. Modbus RTU Communication

### 6.1 General

The Anybus Communicator CAN acts as a Modbus RTU slave on the Modbus RTU network. As such, it does not initiate communication towards other nodes by itself, but can be read from/written to by a Modbus RTU master.

### 6.2 Data Representation

The Input and Output Data areas in the internal memory buffer are used for Modbus RTU data. The amount of data exchanged on the bus depends on the configuration of the Communicator.

When setting up the Modbus RTU communication, make sure that the I/O sizes in the Anybus Communication Manager matches the Modbus RTU master configuraton. The data sizes can be viewed at any time, see “Address Overview” on page 46.

#### 6.2.1 Memory Layout (Internal Memory Buffer)

The data in the input and output data areas is represented as continuous blocks of I/O data. Each data object in a CAN frame adds to the total amount. Usage of the memory can always be seen in the Address Overview, see page 46.

*Example:*

In this example, the I/O sizes for the Communicator has been set to the following values:

IO Size In = 64 registers (128 bytes, 0x0080)

IO Size Out = 48 registers (96 bytes, 0x0060)

Resulting memory layout:

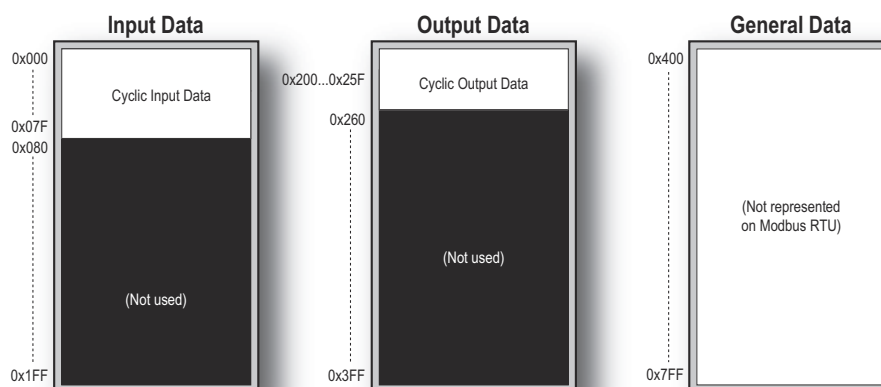

Please note that the two first bytes of the Output and Input Data areas are occupied by the Control/Status Word if this is enabled. Live List and Transmit and Receive Counters are by default mapped to the input memory area from the start address or after the Status Word.

## 6.2.2 Supported Modbus Functions

The Slave Interface acts as a passive node and as such it responds to incoming Queries and accepts broadcast messages. It will not initiate communication autonomously.

In the Anybus implementation, several Modbus functions are associated with the very same data. While this may appear confusing at first, it allows data to be manipulated in a very flexible manner (e.g. it is possible to manipulate individual bits of a register by accessing coils associated with the same memory location).

The following functions can be used to access data in the Slave Interface:

Modbus Function	Function Code	Direction	Associated with Buffer
Read Coil	1	Gateway to Modbus	Input- and Output Buffers
Read Input Discretes	2		
Read Holding Registers	3		
Read Input Registers	4		
Write Coil	5	Modbus to Gateway	Output Buffer
Write Single Register	6		
Force Multiple Coils	15		
Force Multiple Registers	16		
Mask Write Register	22		
Read/Write Registers	23	Bidirectional	Input- and Output Buffers

See also...

- “Coil & Register Map” on page 23

## 6.2.3 Modbus Exceptions

With the exception of broadcast messages, the Modbus Master expects it's slaves to respond within a certain defined time period. If no response is received (e.g. due to a transmission error), this eventually triggers a timeout condition in the Master.

If the Slave Interface receives a Query from the Master, but for some reason is unable to process it (e.g. the Master tries to access a non-existent Register), an Exception is returned to inform the Master of the nature of the problem.

The Slave Interface may issue the following Exception responses:

#	Meaning	Description
01h	Illegal Function	The Query contains an illegal or unsupported function call
02h	Illegal Data Address	The Query contains an illegal data address
03h	Illegal Data Value	The Query contains invalid data

## 6.2.4 Coil & Register Map

The Input & Output Buffers are mapped to coils and registers as follows:

Register #	Coil #	Buffer	Location in Buffer	Comments	
1	1... 16	Input Buffer	000... 001h	Applicable Modbus functions: - Read Coil - Read Input Discretes - Read Holding Registers - Read Input Registers - Read/Write Registers	
2	17... 32		002... 003h		
3	33... 48		004... 005h		
4	49... 64		006... 007h		
5	65... 80		008... 009h		
6	81... 96		00A... 00Bh		
7	97... 112		00C... 00Dh		
...	...		...		
255	4065... 4080		1FC... 1FDh		
256	4081... 4096		1FE... 1FFh		
257... 1024	4097... 16384	-	-	(reserved)	
1025	16385... 16400	Output Buffer	000... 001h	Applicable Modbus functions: - Read Coil - Read Input Discretes - Read Holding Registers - Read Input Registers - Write Coil - Write Single Register - Force Multiple Coils - Force Multiple Registers - Mask Write Register - Read/Write Registers	
1026	16401... 16416		002... 003h		
1027	16417... 16432		004... 005h		
1028	16433... 16448		006... 007h		
1029	16449... 16464		008... 009h		
1030	16465... 16480		00A... 00Bh		
1031	16481... 16496		00C... 00Dh		
...	...		...		
1279	20449... 20464				1FC... 1FDh
1280	20465... 20480				1FE... 1FFh
1281...	20481...		-		-

**Note 1:** Coils are mapped MSB first, i.e. coil 1 corresponds to bit 15 of register 1.

**Note 2:** Modbus RTU uses big endian, e.g. the first byte in the input buffer corresponds to the most significant byte of register 1.

## 6.2.5 Modbus Diagnostics

The Modbus RTU interface features several diagnostic counters which increments each time the interface encounters certain pre-defined events. These counters may provide valuable clues when troubleshooting the Modbus communication, and can be accessed through the standard Modbus Diagnostic function (function code 08h).

The following sub-functions are implemented:

#	Meaning	Description
00h	Return Query Data	Loopback; instructs the slave to return the data from the Query
0Ah	Clear Counters and Diagnostic Register	Clears all diagnostic counters
0Ch	Return Bus Communication Error Count	Returns the no. of detected CRC-errors
0Dh	Return Bus Exception Error Count	Returns the no. of exception responses previously returned by the slave
0Eh	Return Slave Message Count	Returns the number of messages addressed to the slave interface (broadcast included)

## 6.2.6 Network Termination

The end nodes of a RS485-based Modbus RTU network must be terminated in order to avoid reflections on the bus line.

The figure below shows the connection and the values of the internal termination and bias resistors. If the values does not match the network termination convention, external termination must be used.

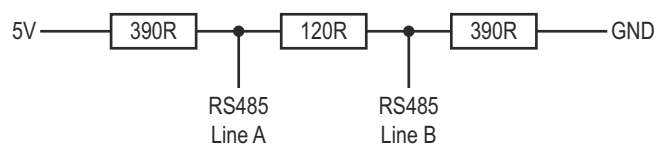

## 7. Anybus Configuration Manager

The Anybus Configuration Manager (ACM) is used to configure all aspects of the Communicator CAN. It also provides different tools for monitoring the module and the CAN subnetwork.

**Note:** The configuration manager automatically allocates addresses and memory space in the input and output areas of the Communicator for the data objects that are configured. It is possible to change these addresses, but it is recommended to finish the configuration using default addresses before starting to change any addresses. A valid address range is always shown in the information section of the main window.

### 7.1 Main Window

The main window in the Anybus Configuration Manager (ACM) is divided into 4 sections as follows:

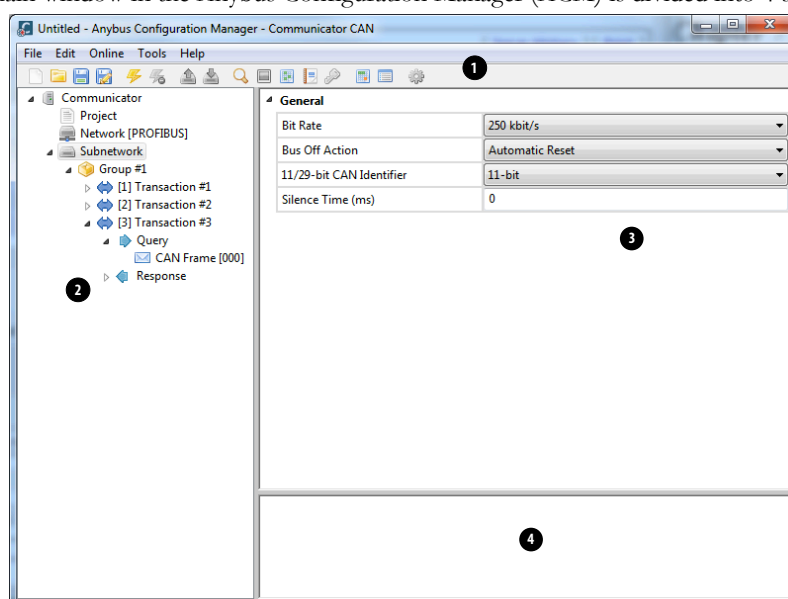

#### 1. Pull-down Menus & Toolbar

The toolbar provides quick access to frequently used functions.

#### 2. Navigation Section

This section is the main tool for building, selecting and altering different levels of the subnetwork configuration. On most entries, right-clicking will give access to the different selections related to that particular entry.

#### 3. Parameter Section

This section holds a list of parameters or options related to the currently selected entry in the Navigation Section.

The parameter value may be specified either using a selection box or entering a value manually, depending on parameter.

#### 4. Information Section





This section presents information related to the parameter where the pointer is hovering.

## 7.1.1 Pull-down Menus

Some of these entries are available directly on the toolbar as well. The toolbar icon is shown next to these entries.

### File

This menu features the following entries:

- **New**  
Create a new configuration. 
- **Open...**  
Open a previously created configuration.  
A configuration is saved with the file extension .hcg. 
- **Save**  
Save the current configuration. 
- **Save As...**  
Save the current configuration under a new name. 
- **Recent Files**  
Displays a list of recently accessed configurations
- **Exit**  
Close the Anybus Configuration Manager.

### Edit

This menu features the following entries:

- **Undo**  
Undo the most recent action. Repeat to undo more actions.
- **Redo**  
Redo the most recent undo.

## Online

This menu features the following entries:

- **Select Connection**

This entry gives the opportunity to select connection for the module.

See also

- “Select Connection” on page 42

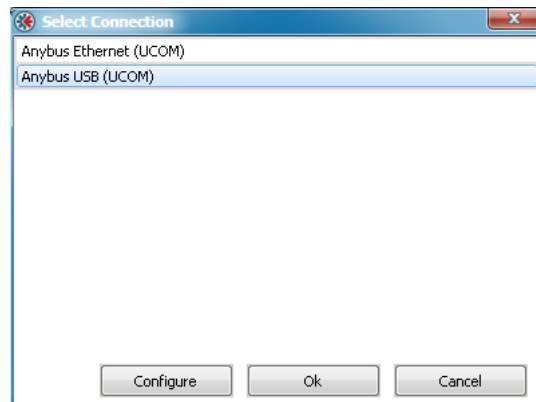

- **Connect/Disconnect**

This entry connects/disconnects the configuration tool to the module.



- **Upload Configuration**

This entry uploads a previously downloaded configuration to the Anybus Configuration Manager.



- **Download Configuration**

This entry downloads the configuration to the Anybus Communicator CAN. Any previously downloaded configuration will be overwritten.<sup>1</sup>



1. ‘Download Configuration’ will only be available if there is a valid configuration to download. Please check the Diagnostics/Status page for information about warnings and faults. See “Diagnostics/Status” on page 47.



## Tools

This menu features the following entries:

- **Monitor/Modify**

This entry opens the Monitor/Modify window that gives easy access to monitoring and modifying the transaction data.

- See “Monitor/Modify” on page 44



- **CAN Line Listener**

Listen in on the CAN communication on the subnetwork.

- See “CAN Line Listener” on page 45



- **Address Overview**

Displays the usage of the different parts of the internal memory of the module.

- See “Address Overview” on page 46



- **Diagnostics/Status**

Displays diagnostics and status of the Communicator and the present configuration.

- See “Diagnostics/Status” on page 47



- **Change Module Password**

Gives the opportunity to change the download and upload passwords for the module.

- See “Password” on page 50



- **Project Summary**

Displays information and a summary of the present configuration. The information is saved in html format and can be displayed in any browser.

- See “Project Summary” on page 49



- **Options**

Selecting this entry gives access to more settings, that can be used to adapt the behavior of the Communicator.

- See “Options” on page 51

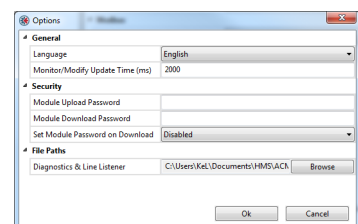

## Help

This menu features the following entry:

- **About...**

Displays information about the Anybus Configuration Manager.

## 8. Basic Settings

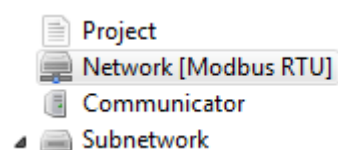

### 8.1 Project

Selecting 'Project' will give the opportunity to enter and store project information.

Project name, project creator, version and description can be entered.

Project Information	
Name	Example
Creator	Appl. Dev.
Version	1.0
Description	This project is an example.

### 8.2 Network Settings

Select 'Network' in the Navigation Section to gain access to the parameters described in this section.

#### General

During start-up of the Communicator, the fieldbus interface of the Communicator is initialized to fit the configuration created in the Anybus Configuration Manager. Optionally, some initialization parameters can be set manually to provide better control over how the data shall be treated by the Communicator.

#### Network Type

The Anybus Configuration Manager supports a wide range of networking systems. Make sure that this parameter is set to the Modbus RTU.

An offline timeout (in milliseconds) can be defined for the Modbus RTU network. An offline indication will be triggered if no Modbus RTU messages have been received during the specified Offline Timeout time. If the parameter is defined to 0, the offline indication will be disabled. Valid range is 0 - 65535.

Network	
Network Type	Modbus RTU
Timeout	
Offline Timeout (ms)	0

## 8.3 Communicator Settings

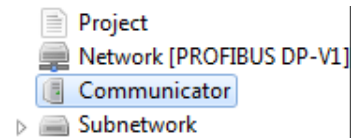

Select 'Communicator' in the Navigation Section to gain access to the parameters described in this section. The figure shows the available parameters.

<b>General</b>	
Control/Status Word	Enabled
Start-up Operation Mode	Idle
Transaction Live List	Map 16 transactions (2 bytes)
<b>Statistics</b>	
Counters	Enable Receive and Transmit Counter
Receive Counter Address	0x004
Transmit Counter Address	0x006
<b>Fatal Event</b>	
Action	Stay in Safe-State

### General

Parameter	Comment
Control/Status Word <sup>a</sup>	If the Control/Status word is enabled it occupies the first two bytes of the out/in area of the memory. See also.. "Control/Status Word" on page 17
Start-up Operation Mode	If the Control Word is enabled, it is possible to decide the start-up mode of the subnetwork. The start-up mode can be either 'Run' or 'Idle'.
Transaction Live List <sup>a</sup>	If the Transaction Live List is enabled it is mapped from the beginning of the input area or, if the Control/Status Word is enabled, after the Status Word. It is possible to map from 8 to 128 transactions, in steps of 8. Each transaction is represented by a bit that tells the system whether the transaction is alive or not. See also ... "Transaction Live List" on page 18

a. If the Control/Status Word or the Transaction Live List are going to be used, it is recommended to enable these before any frames are added when building the configuration, to avoid memory address collisions.

### Statistics

Parameter	Comment
Counters <sup>a</sup>	The receive counter and the transmit counter count successful CAN messages <sup>b</sup> on the subnetwork. If enabled, the counters can be mapped to the input data area. The first free address in the input data area is selected by default. The counters can be disabled and enabled separately.
Receive Counter Address	Enter the address in the input data area where the receive counter shall be mapped. The receive counter occupies 2 bytes.
Transmit Counter Address	Enter the address in the input data area where the transmit counter shall be mapped. The transmit counter occupies 2 bytes.

a. If any counters are going to be used, it is recommended to enable these before any frames are added when building the configuration, to avoid address collisions in the memory.

b. The messages are counted only if they are configured in the Anybus Configuration Manager

### Fatal Event

The action in case of a fatal software event is decided by this parameter

Parameter	Values	Comment
Action	Stay in Safe-State	The Communicator will be locked in the safe state
	Software Reset	The software will be reset and the Communicator will be restarted automatically

## 8.4 Subnetwork Settings

Select 'Subnetwork' in the Navigation Section to gain access to the settings described in this section.

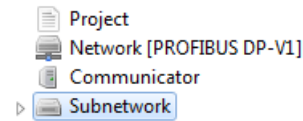

### General

Parameter	Values	Comment
Bit Rate	20 kbit/s 50 kbit/s 100 kbit/s 125 kbit/s 200 kbit/s 250 kbit/s 500 kbit/s 800 kbit/s 1000 kbit/s	Select CAN bit rate on the subnetwork.
Bus Off Action	No Action Automatic Reset	Select what will happen to the CAN controller when the CAN network goes bus off. Available only when the Control/Status Word is not used. Please note that when enabling the Control/Status Word, this parameter will automatically be set to 'No Action'.
11/29-bit CAN Identifier	11 bit 29 bit	Select CAN identifier size on the subnetwork If there are transactions configured when this parameter is changed, the following will happen: - a change from 11 bit to 29 bit identifier will cause the identifier to be padded with zeroes up to 29 bits, keeping the 11 bits at the same location. - a change from 29 bit to 11 bit identifier will cause the upper 18 bits to be deleted and the lower 11 bits kept. WARNING! This may in some cases cause faulty CAN identifiers.
Silence Time (ms)	0 - 65535	Default = 0 (disabled) The minimum time that must elapse between the end of a message and the beginning of the next message. If, for example, a device on the subnetwork is slow and/or does not have a queue for messages, it may be necessary to enter a pause in between messages to ensure that all messages are handled correctly.

## 9. Groups and Transactions

### 9.1 General

The configuration of the Communicator is set up in groups, each containing one or more transactions. Please note that the groups do not represent a physical device on the CAN network. They are a means for structuring the application, and maintaining an overview of it. The maximal number of groups is 128.

A transaction can be either a Produce, a Consume or a Query/Response transaction. Each transaction holds one or more CAN frames, which transport the data on the network. A total of 128 transactions is allowed, and a total of 256 CAN frames.

Each CAN frame can hold up to 8 bytes of data.

Groups and transactions as well as frames and objects (described in the next section) can be copied and pasted in the configuration tree, but only at the same level as they were copied from, or their parent.

### 9.2 Groups

To create a group, right click on 'Subnetwork' and select 'Add Group'. The name of the group can be changed by selecting 'Group' and then entering a new name at 'Group Alias'.

If you want to insert another group, right click on 'Subnetwork' once more. The new group will be added to the end of the list of groups.

If you right click on a group and select 'Insert Group', the new group will be inserted before the selected group.

It is recommended to change the group name, to better present the configuration.

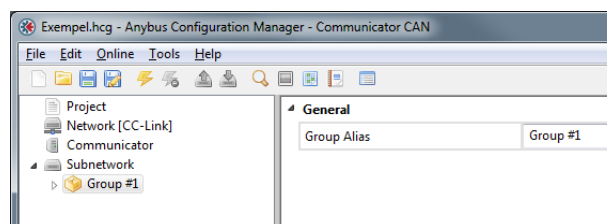

### 9.3 Transactions

There are five kinds of transactions: Produce, Consume, Query/Response, Dynamic Produce and Dynamic Consume.

Selecting the transaction will give the option to give the transaction an alias. The order of the transactions in the tree is given as the transaction number in the parameter section. Each transaction number corresponds to a bit in the transaction live list that can be mapped to the input data area.

**Note:** The transaction live list is always available in the Diagnostics/Status window, even when it is not mapped to the input data area in the memory.

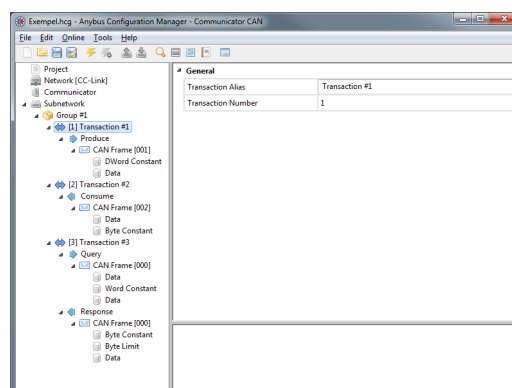

To add a transaction to the group, right click on the group and select either Add Produce, Add Consume, Add Query/Response, Add Dynamic Produce or Add Dynamic Consume.

Each transaction holds one CAN frame by default when added to a group. The dynamic transactions can not hold more than one CAN frame.

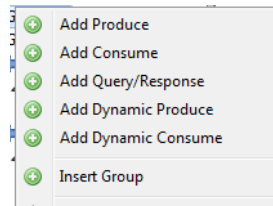

### 9.3.1 Produce

A produce transaction transmits CAN frames on the CAN network for all devices on the network to listen to. A CAN device on the network will use the identifier of the produce transaction to decide if the data is meant for it or not. The Communicator operates as any other device on the CAN network, that produces and transmits data on the network. Selecting 'Produce' gives access to the following parameters:

General	
Produce Alias	Produce
Offline Options	Clear Data
Update Mode	Cyclically
Update on RTR	Enabled
Transmission Complete Byte	Enabled
Transmission Complete Address	0x000
Timing	
Update Time (ms)	10

Parameter	Value	Comment
Produce Alias	-	An alias for the produce transaction (max 16 characters)
Offline Options	Clear Data	Select what will happen to the output data if the Modbus RTU network goes offline
	Freeze Data	
	Stop Transaction	
Update Mode	Cyclically	Defines how the transmission of the transaction is triggered
	On Data Change	
	Single Shot	
	Trigger Byte	
Update on RTR	Disabled	If a message on the configured CAN identifier for a produce transaction is received with the RTR (Remote Transmission Request) bit set, the produce transaction is triggered to be sent. Only available if only one CAN frame is configured in the transaction.
	Enabled	
Transmission Complete Byte	Disabled	When enabled, the Transmission Complete Byte is incremented each time a produce transmission is completed.
	Enabled	
Transmission Complete Address	First available address (default)	If the Transmission Complete Byte is enabled, enter the address here.
Update Time (ms)	1000 (default)	When Update Mode 'Cyclically' is selected, this parameter defines the time interval (ms) between two transmissions. Valid range: 5 - 65535
Trigger Byte Address	First available address (default)	When Update Mode 'Trigger Byte' is selected, this parameter specifies the address of the trigger byte. The transaction will be triggered on a change in this byte.

Right click on 'Produce' to add another CAN frame. For the setup of CAN frames see "Configuration of CAN Frames" on page 39.

### 9.3.2 Consume

A consume transaction listens to CAN frames on the CAN network and collects data from a frame with a matching CAN identifier. The Communicator operates as any other device on the CAN network that listens to all data that is available on the network. Selecting 'Consume' gives access to the following parameters:

General	
Consume Alias	Consume
Offline Options	Clear Data
Consistency Check	Enabled
Timing	
Offline Timeout (ms)	100
Trigger	
Reception Trigger Byte	Enabled
Reception Trigger Address	0x010
Status	
Transaction Status Byte	Enabled
Transaction Status Address	0x001

Parameter	Value	Comment
Consumer Alias	-	An alias for the consume transaction (max 16 characters).
Offline Options	Clear Data	Select what will happen to the input data if the CAN subnetwork goes offline.
	Freeze Data	
Consistency Check	Disabled	When enabled, all frames in the transaction must be received before evaluation. The frames are verified to contain expected data according to the configuration. Once verified, the fieldbus process data is updated with the received data. When disabled, all frames will be evaluated individually and the fieldbus process data is updated directly. The Offline Timeout will be set to 0.
	Enabled	
Offline Timeout	0 (default)	The maximum time before the transaction is considered to be lost. Use 0 to disable the timeout. Valid Range: 0, 10 - 65535.
Reception Trigger Byte	Disabled	When enabled, the Reception Trigger Byte is incremented each time a consume transaction is received.
	Enabled	
Reception Trigger Address	First available address (default)	If the Reception Trigger Byte is enabled, enter the address here.
Transaction Status Byte	Disabled	When enabled, the Transaction Status Byte is updated every time the status of the transaction is changed.
	Enabled	
Transaction Status Address	First available address (default)	If the Transaction Status Byte is enabled, enter the address here.

Right click on 'Consume' to add another CAN frame. For the setup of CAN frames see "Configuration of CAN Frames" on page 39.

#### Transaction Status Byte

If enabled, the transaction status byte holds the following status information for each separate transaction.

Bit	Name	Description
0	Timeout	0 - The transaction has not timed out. 1 - The transaction has timed out.
1	Data error	0 - The transaction does not have data errors. 1 - The transaction has data errors. <sup>a</sup>
2	Not executed	0 - The transaction has been executed at least once. 1 - The transaction has not been executed yet.
3 - 7	(Reserved)	(Always 0)

a. Data errors that can be detected are 'data out of range', 'invalid data size' and 'non-matching constant bytes' (in Constant object).

### 9.3.3 Query/Response

In Query/Response mode the Communicator operates as a master and issues queries to the CAN network. The Communicator will then expect a response within the specified timeout. A Query/Response transaction includes both query CAN frames and response CAN frames.

Selecting Query will give the same options as selecting Produce, except 'Update on RTR', see:

- “Produce” on page 34.

Selecting Response will give the same options as selecting Consume, see

- “Consume” on page 35.

Please note that the Offline Timeout value indicates the maximum time that the Communicator will wait for an answer before an error is issued. For a cyclic query, the offline timeout must be lower than the update time.

Right click on either 'Query' or 'Response' to add a new CAN frame. For the setup of CAN frames see “Configuration of CAN Frames” on page 39.

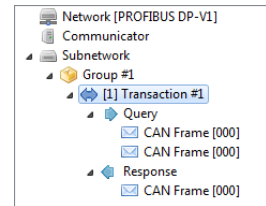



### 9.3.4 Dynamic Produce

Only one dynamic produce transaction can be added to a configuration. The function and parameters are similar to a produce transaction with the exception that some parameters can be accessed by the network master in the output data area or the general data area. At the same time, these parameters are not accessible via the Anybus Configuration Manager.

Parameters that are available in the Anybus Configuration Manager are given in the table below.

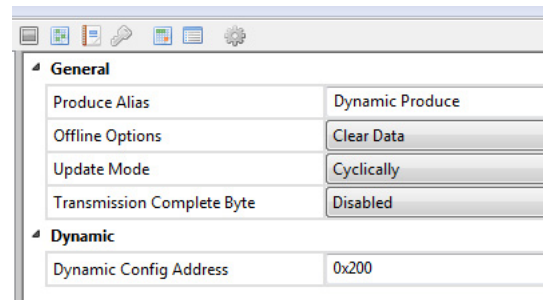

Parameter	Value	Comment
Produce Alias	-	An alias for the dynamic produce transaction (max 16 characters)
Offline Options	Clear Data	Select what will happen to the output data if the Modbus RTU network goes offline
	Freeze Data	
	Stop Transaction	
Update Mode	Cyclically	Defines how the transmission of the transaction is triggered
	On Data Change	
	Single Shot	
	Trigger Byte	
Transmission Complete Byte	Disabled	When enabled, the Transmission Complete Byte is incremented each time a produce transmission is completed.
	Enabled	
Transmission Complete Address	First available address (default)	If the Transmission Complete Byte is enabled, enter the address here.
Trigger Byte Address	First available address (default)	When Update Mode 'Trigger Byte' is selected, this parameter specifies the address of the trigger byte. The transaction will be triggered on a change in this byte.
Dynamic Config Address	First available address (default)	This parameter specifies the memory address for the dynamically configurable parameters.

Parameters that can be changed dynamically are stored at the specified memory address in the order given in the table below. These parameters are initialized at 0.

Parameter	Size	Comment	
CAN-ID	2 or 4 bytes	11 bit or 29 bit CAN identifier	
Update time	2 bytes	When Update Mode 'Cyclically' is selected, this parameter defines the time interval (ms) between two transmissions. Valid range: 5 - 65535. Cyclic update is stopped if this parameter is set to 0.	
Data length (bit 0-3)	1 byte	The data length is given in bits 0-3 in this byte. At initialization this value is set to 0 and can later be changed up to the maximal data length entered for the data object in the Anybus Configuration Manager.	
RTR bit (bit 4)			Signals a remote transmission request.
Reserved (bit 5 - 7)			

### 9.3.5 Dynamic Consume

Only one dynamic consume transaction can be added to a configuration. The function and parameters are similar to a consume transaction with the exception that some parameters can be accessed by the network master in the output data area or the general data area. At the same time, these parameters are not accessible via the Anybus Configuration Manager.

Parameters that are available in the Anybus Configuration Manager are given in the table below.

Parameter	Value	Comment
Consumer Alias	-	An alias for the dynamic consume transaction (max 16 characters).
Offline Options	Clear Data	Select what will happen to the input data if the CAN subnetwork goes offline.
	Freeze Data	
Reception Trigger Byte	Disabled	When enabled, the Reception Trigger Byte is incremented each time a consume transaction is received.
	Enabled	
Reception Trigger Address	First available address (default)	If the Reception Trigger Byte is enabled, enter the address here.
Transaction Status Byte	Disabled	When enabled, the Transaction Status Byte is updated every time the status of the transaction is changed. <sup>a</sup>
	Enabled	
Transaction Status Address	First available address (default)	If the Transaction Status Byte is enabled, enter the address here.
Dynamic Config Address	First available address (default)	This parameter specifies the memory address for the dynamically configurable parameters.

a. See "Transaction Status Byte" on page 35.

Parameters that can be changed dynamically are stored at the specified memory address in the order given in the table below. These parameters are initialized at 0.

Parameter	Size	Comment
CAN-ID	2 or 4 bytes	11 bit or 29 bit CAN identifier
Offline Timeout	2 bytes	The maximum time before the transaction is considered to be lost. Use 0 to disable the timeout. Valid Range: 0, 10 - 65535.
Data length (bit 0-3)	1 byte	The data length is given in bits 0-3 in this byte. At initialization this value is set to 0 and can later be changed up to the maximal data length entered for the data object in the Anybus Configuration Manager.
Reserved (bit 4 - 7)		

## 10. Configuration of CAN Frames

### 10.1 General

Each transaction includes one or more CAN frames. A total of 256 CAN frames is allowed. Right-clicking on a transaction will give the opportunity to add another frame to the transaction.

The Anybus Configuration Manager makes it possible to decide the configuration of the 8 bytes of data that can be included in each frame. The configuration manager automatically allocates memory space in the input and output areas of the Communicator for the data objects that are configured in the frames. The result can be seen in the Address Overview, see page 46. Any address conflicts will turn up red in this view.

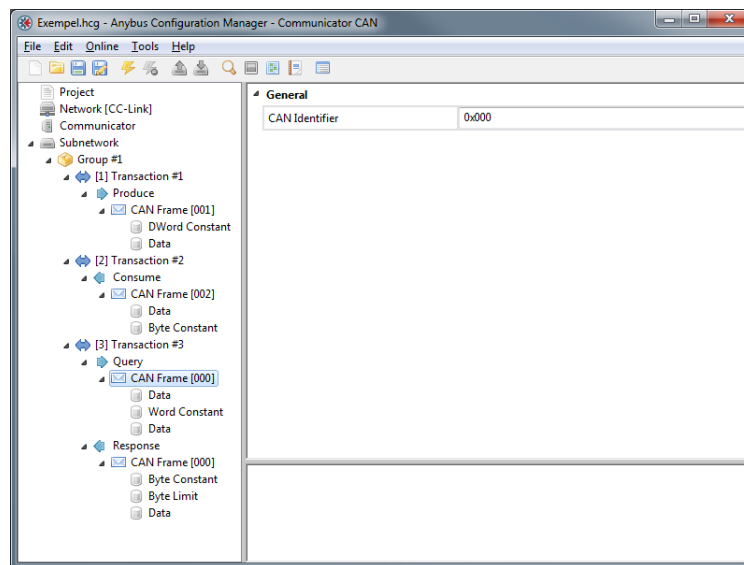

**Note:** A CAN frame can not contain more than 8 bytes of data. It is possible to configure the data area in each frame, but the size of the combination of objects must not exceed 8 bytes.

#### 10.1.1 CAN Identifiers

Each frame has a CAN identifier, to make it possible for each node on the CAN network to recognize data meant for it. Default identifier is '0'. It can be changed by selecting the CAN Frame and enter the new CAN Identifier in the Parameter window.

The CAN frame has either a 11-bit identifier or a 29-bit identifier. If the size of the identifier is changed, an 11-bit identifier will have the 11 original bits padded with zeroes in front. A 29 bit identifier will have its 18 highest bits cut, which may cause a not valid 11-bit identifier.

It is possible to have several frames in one transaction. The first frame in a Consume or Response transaction must have a CAN identifier that does not appear in any other Consume or Response transaction. Consecutive frames within a received transaction may have the same identifier, on two conditions:

- The first part of the data area in the frame is a byte, word or Dword constant with a unique value compared to other frames with the same identifier within the transaction.
- If any frame with another identifier is added to the transaction, it must not break the sequence of frames with identical identifiers.

## 10.2 Produce/Query CAN Frame

The following objects and parameters are configurable in a CAN frame in a produce transaction, or when used in the query part of a query/response transaction. To add objects to the 8 byte data area of the frame, right-click on CAN Frame.

Object	Parameters	Description/Comment							
Data	Data Length (Bytes)	A data object can occupy 1 - 8 bytes (default =1).							
	Data Address	Address in the data area where the object shall be mapped. Default: The first available position is used.							
	Swap	<table border="0"> <tr> <td>Values:</td> <td>Result (original value = 0102 0304):</td> </tr> <tr> <td>No Swapping (default)</td> <td>0102 0304</td> </tr> <tr> <td>Word Swap</td> <td>0201 0403</td> </tr> <tr> <td>Double Word Swap</td> <td>0403 0201</td> </tr> </table>	Values:	Result (original value = 0102 0304):	No Swapping (default)	0102 0304	Word Swap	0201 0403	Double Word Swap
Values:	Result (original value = 0102 0304):								
No Swapping (default)	0102 0304								
Word Swap	0201 0403								
Double Word Swap	0403 0201								
Byte Constant	Value (1 byte, valid range: 0x00 - 0xFF)	Constant value to be transmitted (little endian).							
Word Constant	Value(2 bytes, valid range: 0x0000 - 0xFFFF)	Constant value to be transmitted (little endian).							
Dword Constant	Value (4 bytes, valid range: 0x00000000 - 0xFFFFFFFF)	Constant value to be transmitted (little endian).							

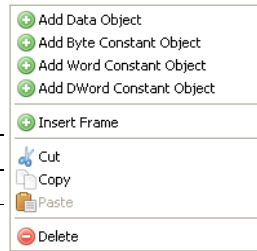

## 10.3 Consume/Response CAN Frame

The following objects and parameters are configurable in a CAN frame in a consume transaction, or when used in the response part of a query/response transaction. To add objects to the 8 byte data area of the frame, right-click on CAN Frame.

Object	Parameters	Description/Comment							
Data	Data Length (Bytes)	A data object can occupy 1 - 8 bytes (default =1).							
	Data Address	Address in the data area where the object shall be mapped. Default: The first available position shall be used.							
	Swap	<table border="0"> <tr> <td>Values:</td> <td>Result (original value = 0102 0304):</td> </tr> <tr> <td>No Swapping (default)</td> <td>0102 0304</td> </tr> <tr> <td>Word Swap</td> <td>0201 0403</td> </tr> <tr> <td>Double Word Swap</td> <td>0403 0201</td> </tr> </table>	Values:	Result (original value = 0102 0304):	No Swapping (default)	0102 0304	Word Swap	0201 0403	Double Word Swap
Values:	Result (original value = 0102 0304):								
No Swapping (default)	0102 0304								
Word Swap	0201 0403								
Double Word Swap	0403 0201								
Byte Constant	Value (1 byte, valid range: 0x00 - 0xFF)	When receiving a message with a constant, the received value will be checked against this value. If the values differ, the message will be ignored (little endian).							
Word Constant	Value(2 bytes, valid range: 0x0000 - 0xFFFF)	When receiving a message with a constant, the received value will be checked against this value. If the values differ, the message will be ignored (little endian).							
Dword Constant	Value (4 bytes, valid range: 0x00000000 - 0xFFFFFFFF)	When receiving a message with a constant, the received value will be checked against this value. If the values differ, the message will be ignored (little endian).							

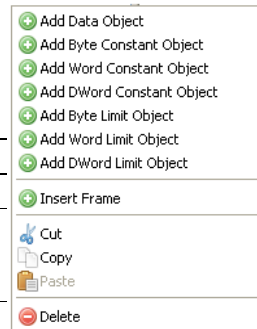

Object	Parameters	Description/Comment
Byte Limit (1 byte, valid range: 0x00 - 0xFF)	Minimum Value	When receiving a message with a limit object, the received value will be checked against the minimum value. If the received value is lower than the minimum value, the message will be ignored.
	Maximum Value	When receiving a message with a limit object, the received value will be checked against the maximum value. If the received value is larger than the maximum value, the message will be ignored.
Word Limit (2 bytes, valid range: 0x0000 - 0xFFFF)	Minimum Value	When receiving a message with a limit object, the received value will be checked against the minimum value. If the received value is lower than the minimum value, the message will be ignored.
	Maximum Value	When receiving a message with a limit object, the received value will be checked against the maximum value. If the received value is larger than the maximum value, the message will be ignored.
Dword Limit (4 bytes, valid range: 0x00000000 - 0xFFFFFFFF)	Minimum Value	When receiving a message with a limit object, the received value will be checked against the minimum value. If the received value is lower than the minimum value, the message will be ignored.
	Maximum Value	When receiving a message with a limit object, the received value will be checked against the maximum value. If the received value is larger than the maximum value, the message will be ignored.

## 10.4 CAN Frames in Dynamic Transactions

A dynamic transaction must consist of one frame. Only one object, a data object, can be added to the 8 byte data area of this frame. .

The CAN Identifier of the CAN frame in a dynamic transaction can not be set in the Anybus Configuration Manager. The identifier is stored in the output data area or the general data area.

The Max Data Length of the data object is entered in the configuration manager, but the actual data length is given by the parameter mapped to the output data area or the general data area.

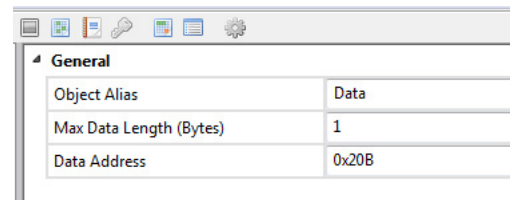

## 11. Online

The entries in the Online menu are used to select and connect to a Anybus Communicator CAN module and to upload/download the configuration.

- Select Connection
- Connect/Disconnect
- Upload Configuration
- Download Configuration

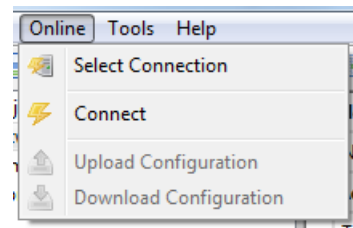

Connect the Communicator that is to be configured to your PC. The configuration can always be downloaded to the Communicator using the USB type 2 connector and the included USB cord. If the industrial network interface supports Ethernet, a suitable LAN cable can be used to download the configuration. Apply power to the module.

### 11.1 Select Connection

To be able to access the module, start by choosing 'Select Connection'.

The module supports Ethernet and USB connections.

**Note:** Although the Anybus Ethernet (UCOM) connection is available in the connection list, it can in practice only be used if the module has an RJ45 connector for Ethernet.

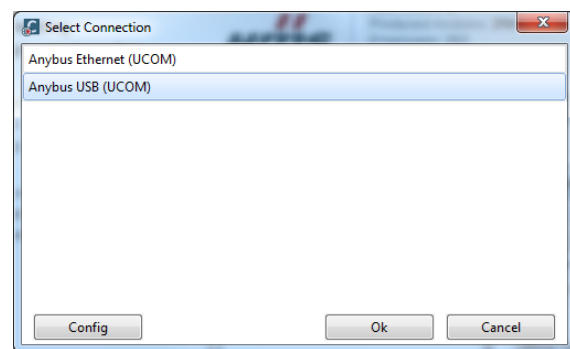

#### General

When a connection is selected, the PC running the ACM will lock to that specific Communicator. If the USB connection is used, the Communicator will be identified by its serial number. If the Ethernet connection is used, the IP address will be used for identification. If the configuration is to be downloaded to another module, using the same PC, the process of selecting connection will have to be repeated for that specific module.

It is recommended to select a specific Communicator for the connection, as this will diminish the risk of downloading the wrong configuration.

### Anybus Ethernet (UCOM) Connection

Selecting ‘Anybus Ethernet (UCOM)’ and pressing ‘Configure’ opens a window where available Anybus Communicator CAN modules are listed.

To scan the network for further modules, press the ‘Scan’ button at the bottom of the window.

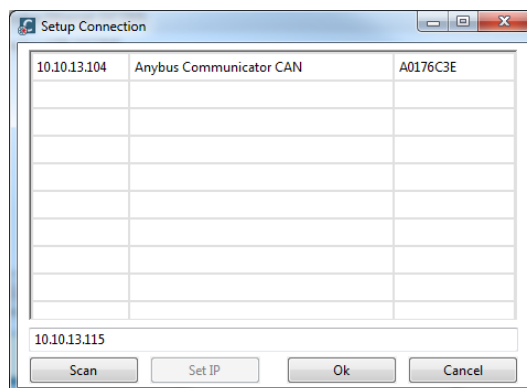

If the IP settings for a module are not set, it is possible to set these by pressing the ‘Set IP’ button. The module can be identified by the MAC Id listed in the rightmost column.

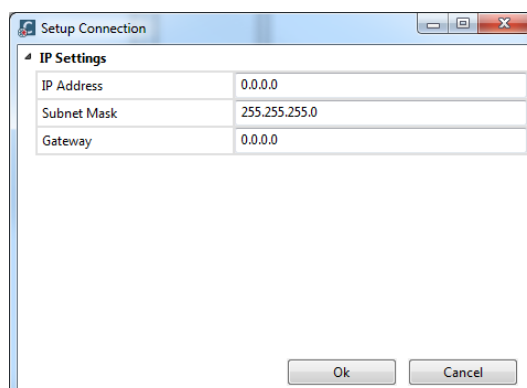

**Note:** These IP settings will be overwritten at the next power up of the module, if the settings are changed within the configuration.

### Anybus USB (UCOM) Connection

To use a USB connection, select ‘Anybus USB (UCOM)’. Continue by pressing ‘Configure’ to open the ACM USB Connection window. The dropdown menu in this window shows available Anybus Communicator CAN modules.

There are also the options to either manually enter the serial number of a desired device or to select ‘first available device’ to download a configuration to.

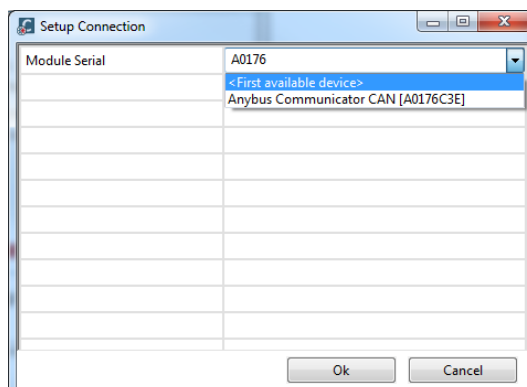

## 11.2 Connect/Disconnect

The Communicator is connected/disconnected using this entry in the menu.

## 11.3 Download and Upload Configuration

Selecting ‘Download Configuration’ downloads the configuration to the Communicator. Any configuration previously present in the ACM will be overwritten.

Selecting ‘Upload Configuration’ will fetch the configuration in the connected Communicator to the Anybus Configuration Manager.

If the configuration is to be downloaded to another Communicator, change the connection, see ‘Select Connection’ on page 42.

## 12. Anybus Configuration Manager Tools

The Anybus Configuration Manager (ACM) gives access to different tools for monitoring and controlling the module and the CAN subnetwork:

- Monitor/Modify
- CAN Line Listener
- Address Overview
- Diagnostics/Status
- Reassign Addresses
- Project Summary
- Password
- Options

### 12.1 Monitor/Modify

Selecting this option in the Tools menu opens this window, where the data areas of the transactions can be monitored. If the configuration downloaded to the Communicator is the same as is open in the ACM, it is possible to monitor and modify the transactions. Pressing the green button on the left starts the monitoring/modifying:

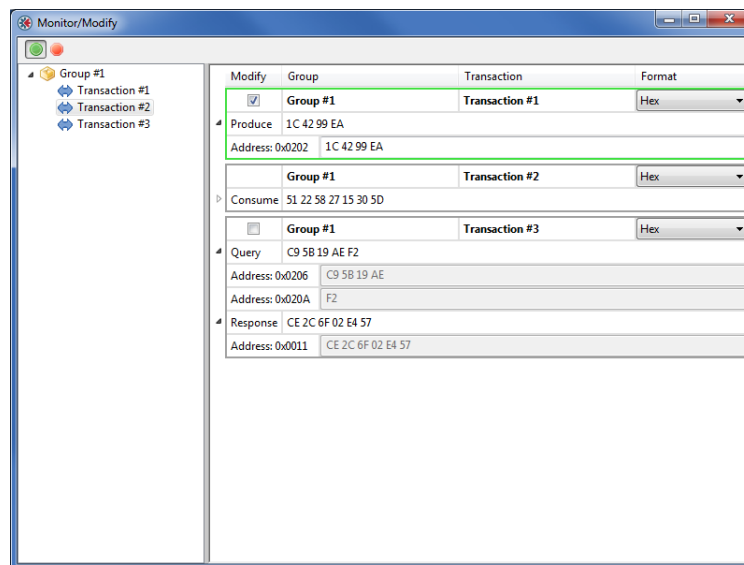

If Modify is enabled, it is possible to change the data values during runtime in Produce transactions and in the Query part of Query/Response transactions, i.e. only the out area of the Communicator can be modified. This will inhibit any data from the industrial network (Modbus RTU), but input data from the CAN network will still be updated.

**Note 1:** Addresses in the general area range can not be modified. If a transaction only has addresses in the general area, the Modify check box will be disabled.

**Note 2:** If a transaction is defined to transmit on a change of state in a trigger byte, this transaction can not be modified by this tool.



## 12.2 CAN Line Listener

The CAN Line Listener gives the opportunity to log the traffic on the CAN network. Any log can be saved for later use. The 5000 latest frames are logged. This is done continuously, or it is possible to stop logging after 5000 frames from a defined time.

The CAN Line Listener shows all CAN frames present on the CAN network, not only those sent or received by the Communicator. Information about CAN frames, that have identifiers present in the configuration, that is downloaded to the Communicator, is shown in black text. Information about all other frames is shown in gray text. Clicking on the save icon will save the log at the location entered in the Tools/Options dialogue, see “Options” on page 51.

Please note that the configuration in the ACM and the configuration in the Communicator have to match.

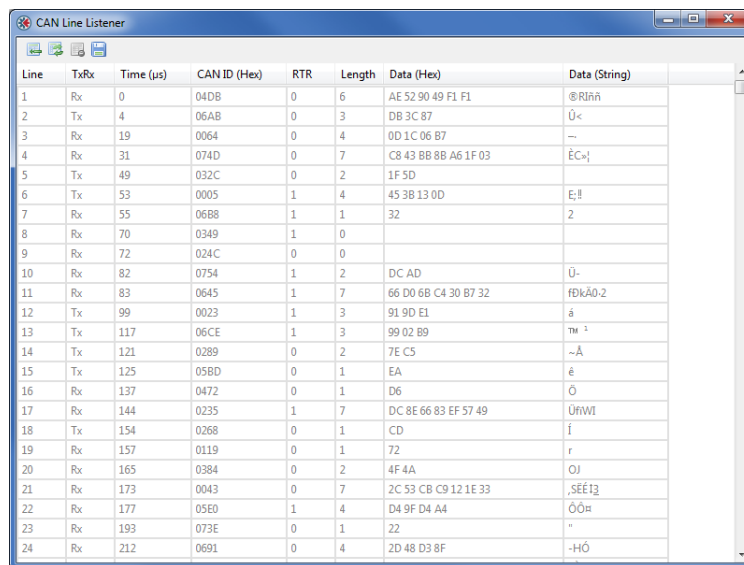

Line	Tx/Rx	Time (µs)	CAN ID (Hex)	RTR	Length	Data (Hex)	Data (String)
1	Rx	0	04DB	0	6	AE 52 90 49 F1 F1	@Rlnñ
2	Tx	4	06AB	0	3	DB 3C 87	Ù<
3	Rx	19	0064	0	4	0D 1C 06 B7	--
4	Rx	31	074D	0	7	C8 43 8B 8B A6 1F 03	ËC-;
5	Tx	49	032C	0	2	1F 5D	
6	Tx	53	0005	1	4	45 3B 13 0D	E;!
7	Rx	55	0688	1	1	32	2
8	Rx	70	0349	1	0		
9	Rx	72	024C	0	0		
10	Rx	82	0754	1	2	DC AD	Ù-
11	Rx	83	0645	1	7	66 D0 6B C4 30 B7 32	fBkÄ0-2
12	Tx	99	0023	1	3	91 9D E1	ä
13	Tx	117	06CE	1	3	99 02 B9	™ ð
14	Tx	121	0289	0	2	7E C5	--Ä
15	Tx	125	058D	0	1	EA	ë
16	Rx	137	0472	0	1	D6	Ö
17	Rx	144	0235	1	7	DC 8E 66 83 EF 57 49	ÙñWl
18	Tx	154	0268	0	1	CD	ï
19	Rx	157	0119	0	1	72	r
20	Rx	165	0384	0	2	4F 4A	OJ
21	Rx	173	0043	0	7	2C 53 CB C9 12 1E 33	,SEE13
22	Rx	177	05E0	1	4	D4 9F D4 A4	ÖÖπ
23	Rx	193	073E	0	1	22	"
24	Rx	212	0691	0	4	2D 48 D3 8F	-HÖ

**Note:** The CAN Line Listener will only display data if the RTR bit is NOT set.

## 12.3 Address Overview

The Address Overview tool shows the usage of the different memory areas in the module. It gives an easy view of any collisions of data that are present in the different memory areas. If needed, the memory location for the data of one transaction at a time, can be shown.

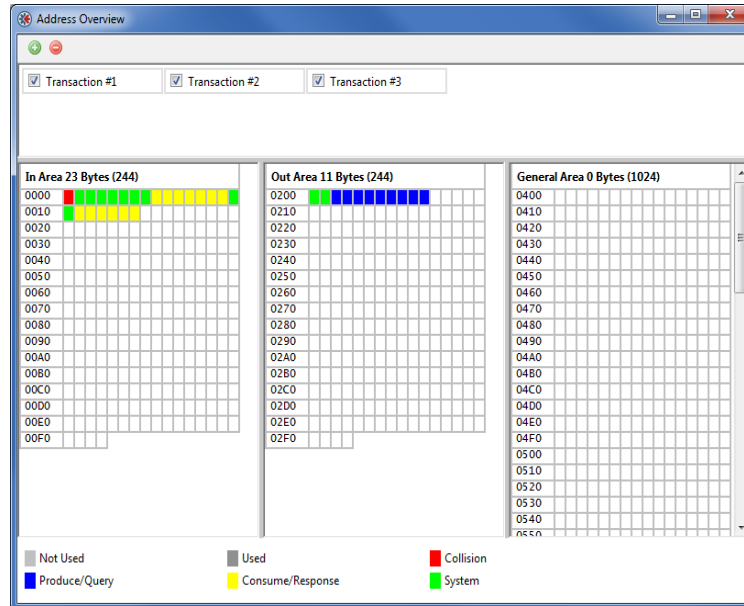

**Note:** The Address Overview is an offline tool with no reference to the module. It shows the memory usage of the the configuration that is present in the Anybus Configuration Manager at the moment.

## 12.4 Diagnostics/Status

The Diagnostics/Status tool gives access to diagnostics and status information of different kinds.

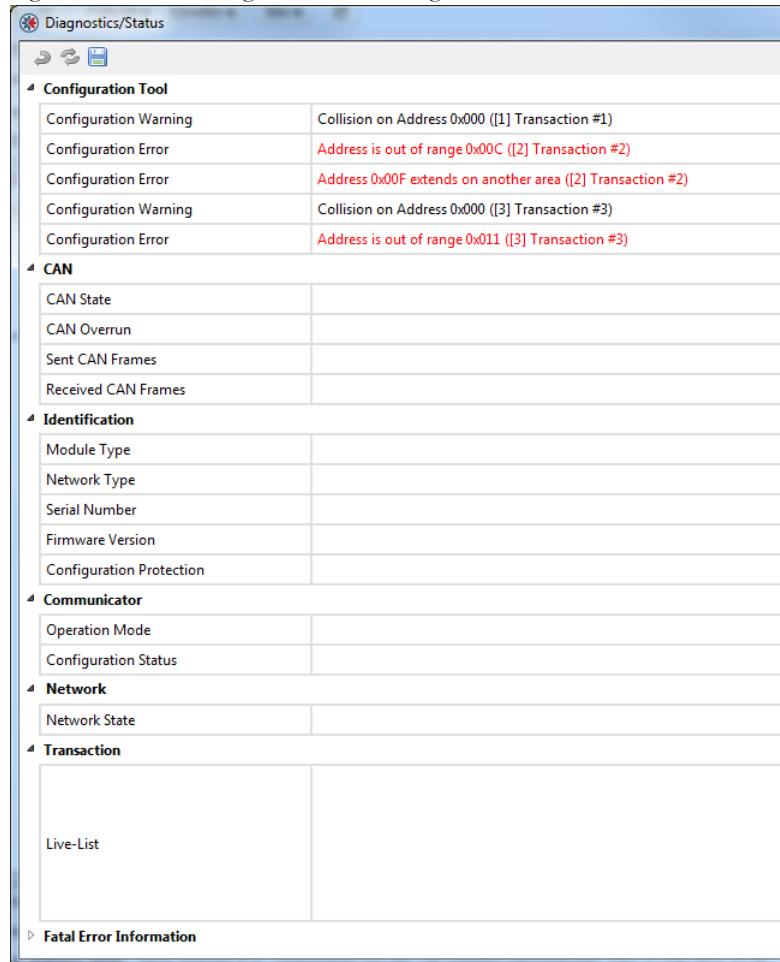

Item	Description
Configuration Tool	The configuration is validated by the ACM and any errors will be reported here, e.g. if the some address has been used for several transactions or if the same CAN identifier is used for more than one transaction. This is the only section of the Diagnostic/Status window that can be used when the configuration tool is not connected to a Communicator. <b>Note:</b> This information is valid for the configuration in the tool only, and does not relate to any configuration stored in the module.
CAN	Information on the status of the CAN subnetwork
Identification	Information on the module
Communicator	This item gives the operation mode and the configuration status of the Communicator
Network	Network state
Transaction	The live list will be shown here. It can also be kept in the input memory area, see 4-18 "Transaction Live List".
Fatal Error Information	If the Communicator is subject to a fatal error, this information is used by HMS support when troubleshooting the module. Please contact HMS support at <a href="http://www.anybus.com">www.anybus.com</a> if a fatal error occurs.

The figure below shows an example of what the section Fatal Error Information may look like.

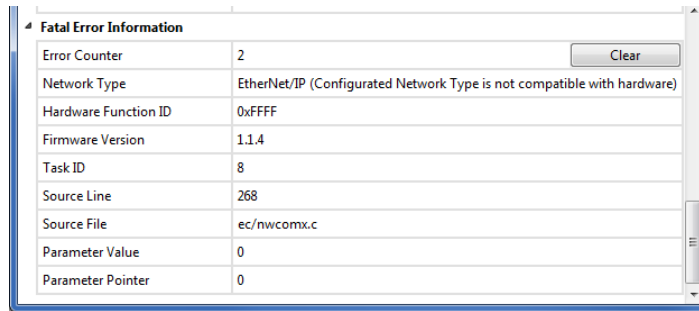

Fatal Error Information	
Error Counter	2
Network Type	EtherNet/IP (Configurated Network Type is not compatible with hardware)
Hardware Function ID	0xFFFF
Firmware Version	1.1.4
Task ID	8
Source Line	268
Source File	ec/nwcomx.c
Parameter Value	0
Parameter Pointer	0

The information in the Diagnostics/Status window can be saved by clicking on the save icon (file format CSV). The file will be saved at the location entered in the Tools/Options dialogue, see “Options” on page 51.

## 12.5 Reassign Addresses

This tool sorts all assigned data and puts it in order, from the beginning of the memory area and on. It also removes any collisions. The result can be seen using the tool “Address Overview”.

Note that there will be no confirmation notice after clicking the “Reassign Addresses” button.

## 12.6 Project Summary

Project information and a summary of the configuration is saved as a html file and can be read in any browser. The file is saved as the location entered in the Tools/Options dialogue, see “Options” on page 51.

Selecting ‘Project Summary’ will open a browser window that displays the summary:



**Anybus Configuration Manager**  
**Communicator CAN**  
Version 1.1.1.3

---

**Information**

Project Name	Example
Project Creator	Appl. Dev.
Project Version	1.0
Project Description	Example Project
Document Date	2011-09-16 13:52:45

**Configuration**

**Network**

Network Type:	EtherNet/IP
TCP/IP Settings:	Enabled
IP Address:	192.168.0.1
Subnet Mask:	255.255.255.0
Gateway:	0.0.0.0
Modbus Addressing Mode:	Disabled
Modbus Connection Timeout:	60
Exact IO Match:	Disabled

**Communicator**

Control/Status Word:	Enabled
Start-up Operation Mode:	Idle
Transaction Live List:	Map 16 transactions (2 bytes)
Receive Counter Address:	0x004
Transmit Counter Address:	0x006
Action:	Stay in Safe-State

**Subnetwork**

Bit Rate:	250 kbit/s
Bus Off Action:	No Action
11/29-bit CAN Identifier:	11 bit

**Group #1 > [1] Transaction #1**

Transaction:	Produce
Offline Options:	Clear Data
Update Mode:	Cyclically
Update on RTR:	Enabled
Transmission Complete Address:	0x00F
Update Time (ms):	10
CAN Frame [001], DWord Constant:	Value: 0xABCDEF00
CAN Frame [001], Data (4 bytes):	Address: 0x202

**Group #1 > [2] Transaction #2**

Transaction:	Consume
Offline Options:	Clear Data
Offline Timeout (ms):	100
Reception Trigger Address:	0x010
CAN Frame [002], Data (7 bytes):	Address: 0x008
CAN Frame [002], Byte Constant:	Value: 0x22

**Group #1 > [3] Transaction #3**

Transaction:	Query
Offline Options:	Clear Data
Update Mode:	Cyclically
Transmission Complete Address:	0x000
Update Time (ms):	10
CAN Frame [000], Data (4 bytes):	Address: 0x206
CAN Frame [000], Word Constant:	Value: 0x0000
CAN Frame [000], Data (1 byte):	Address: 0x20A
Transaction:	Response
Offline Options:	Clear Data
Offline Timeout (ms):	0
CAN Frame [000], Byte Constant:	Value: 0x00
CAN Frame [000], Byte Limit:	Value: 0x00 - 0x00
CAN Frame [000], Data (6 bytes):	Address: 0x011

## 12.7 Password

It is possible to password protect a configuration. Passwords can be set both for uploading and downloading a configuration.

Passwords are set in the Options window, see “Options” on page 51. The same password can be used for uploading a configuration and for downloading a configuration. If the “Set Module Password on Download” parameter is enabled, the password will be downloaded to the module along with the configuration. When a configuration is protected by passwords you can still use the tools that are listed in this chapter. It is only the configuration by itself that is protected.

The passwords in a connected module can be changed directly from the ‘Change Module Password’ entry in the Tools menu. If no password has been set previously, the “Old Password” box should be left empty.

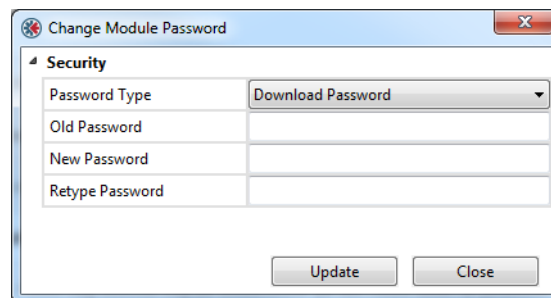

## 12.8 Options

Selecting this entry gives access to more settings, that can be used to adapt the behavior of the Communicator.

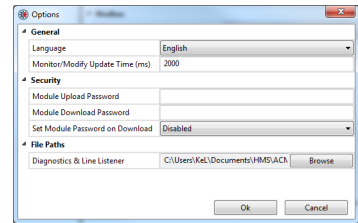

Item	Subitem	Comment
General	Language	
	Monitor/Modify Update Time (ms)	Enter the time between monitor/modify updates in milliseconds <sup>a</sup> . Valid range: 1000 to 60000 Default: 2000
Security <sup>b</sup>	Module Upload Password	
	Module Download Password	
	Set Module Password on Download	Default: Disabled
File Paths	Diagnostics & Line Listener	By default the logs and the project summary are saved in the user catalog in Windows (My Documents\HMS\ACM Communicator CAN). To change this, browse to or enter the name of the folder where the logs shall be saved. <sup>c</sup> If the folder entered does not exist, the ACM will use the default address.

- If a low value is entered, it may affect the performance of the Communicator, i.e. the data throughput delay will be longer.
- See "Password" on page 50.
- The log files contain time stamped versions of the CAN Line Listener, Diagnostics/Status and Project Summary. When the "Project Summary" button is pressed a time stamped version is automatically saved in a subfolder named "Project Summary Logs".  
When the Save button in the CAN Line Listener window is pressed a time stamped version is automatically saved in a subfolder named "Line Listener Logs".  
When the Save button in the Diagnostics/Status window is pressed a time stamped version is automatically saved in a subfolder named "Diagnostics Logs".

## **A. Technical Specification**

### **A.1 Protective Earth (PE) Requirements**

The product must be connected to protective earth (PE) via the DIN-rail connector in order to achieve proper EMC behavior.

HMS Industrial Networks does not guarantee proper EMC behavior unless these PE requirements are fulfilled.

### **A.2 Power Supply**

#### **Supply Voltage**

The Communicator requires a regulated 24 V $\pm$ 10% DC power source.

#### **Power Consumption**

The typical power consumption is 150 mA at 24 V.

### **A.3 Environmental Specification**

#### **A.3.1 Temperature**

##### **Operating**

-25° to +55° Celsius

(Test performed according to IEC-60068-2-1 and IEC 60068-2-2.)

##### **Non Operating**

-40° to +85° degrees Celsius

(Test performed according to IEC-60068-2-1 and IEC 60068-2-2.)

#### **A.3.2 Relative Humidity**

The product is designed for a relative humidity of 5 to 95% non-condensing.

Test performed according to IEC 60068-2-30.



## A.4 EMC (CE) Compliance

EMC compliance testing has been conducted according to the Electromagnetic Compatibility Directive 2004/108/EC. For more information please consult the EMC compliance document, see product/support pages for Anybus Communicator CAN to CANopen (slave) at [www.anybus.com](http://www.anybus.com).

## B. Configuration Example

This appendix gives an example of the configuration of an Anybus Communicator CAN to collect data from a temperature sensor and to control and monitor a motor.

1. Start the Anybus Configuration Manager - Communicator CAN (ACM).
2. Choose industrial network. The example is the same irrespective of industrial network, but in an application it is important to choose network first, as the ACM will show the amount of data that can be transferred.

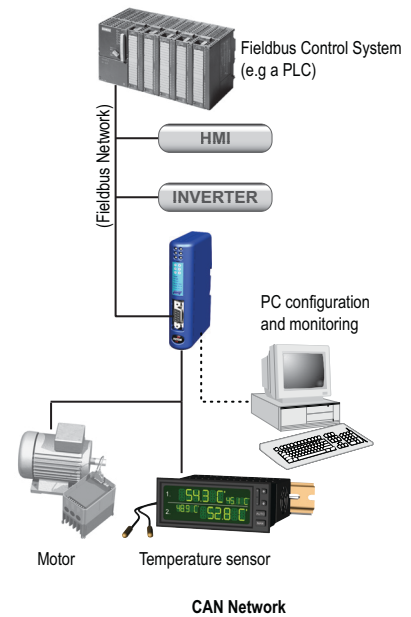

3. Select 'Communicator'.

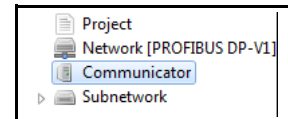

- Enable the Control/Status Word.  
If the Control/Status Word is to be used in a configuration, it is recommended to enable it before adding any transactions to the configuration. The Control/Status Word is positioned at the start of the memory, and this may cause address conflicts if any data objects have been configured previously.  
For more information on the Control/Status Word, see page 18.
- Leave the rest of the parameters at default values.

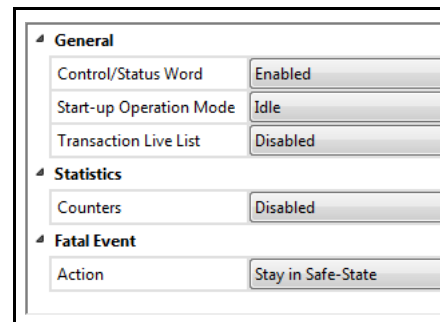

## 4. Select 'Subnetwork'.

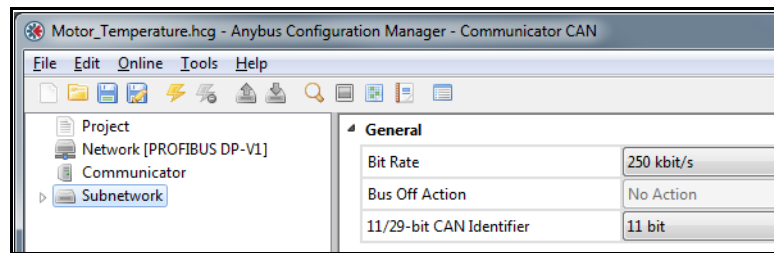

If the Control/Status Word is enabled no Bus Off Action can be defined.

## 5. Add Groups.

- Right-click on 'Subnetwork' and add two groups to the navigation tree, one for each device on the CAN network.
- Rename them e.g. Temp. Sensor and Motor. Renaming is essential to enable other users than the designer of the application to comfortably monitor and modify the application.

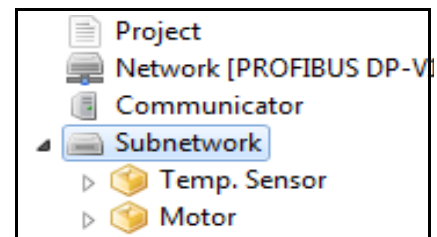

The CAN network is message-based, but using the group to structure the transactions will make it conceptually easier to build a configuration.

## 6. Add transactions to Temp. Sensor group.

The temperature sensor needs to be initialized. It needs instructions during runtime, and it will deliver temperature data to the Communicator.

A suitable transaction for an initialization is a query-response transaction which is run once at start up. A query-response transaction ensures an acknowledgement of a successful initialization. In this example, the initialization is performed in two steps.

Also, instructions and information need to be sent to the sensor and data collected. A produce transaction sends information to the network and a consume transaction will collect information.

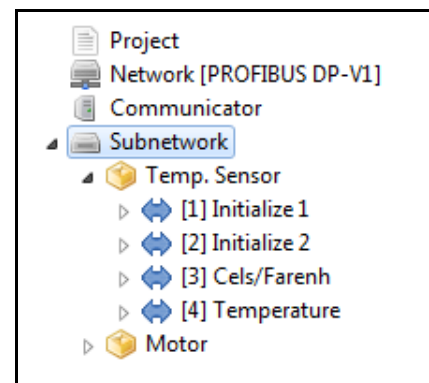

- Add two query-response transactions and rename them 'Initialize 1' and 'Initialize 2'.
- On each, select Query and change Update Mode to Single Shot. The transactions will be run once at startup to initialize the communication with the temperature sensor.
- Leave the rest of the parameters at default values.
- Add one Produce transaction to send information and instructions to the temperature sensor. Rename the transaction to 'Cels/Farenh' and set Update Mode to Cyclically.
- Leave the rest of the parameters at default values.
- Finally add one Consume transaction to collect the data cyclically from the temperature sensor. Rename the transaction to 'Temperature' and set Update Mode to Cyclically.
- Leave the rest of the parameters at default values.

7. Add frames to the transactions.

- Right-click on 'Query' in 'Initialize 1' and add a CAN frame.
- Select the frame.
- Set a unique CAN identifier to the frame. The CAN identifier shall be recognized on the network by the temperature sensor.
- Right click on the frame to define the components of the 8 byte data area in the frame, see figure to the right.
- Enter constant values where applicable.
- Right-click on 'Response' in 'Initialize 1' and repeat the procedure.

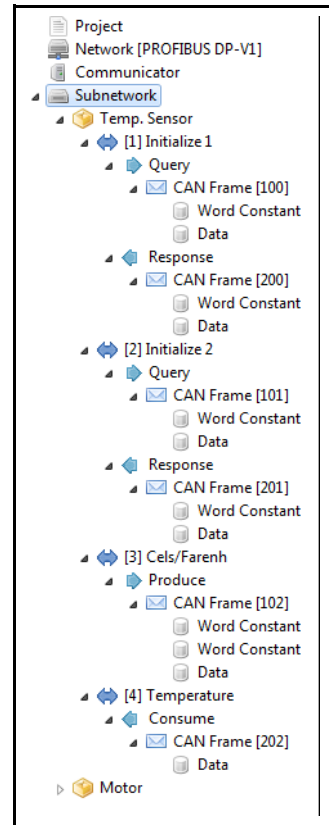

Addresses in the input and output areas of the internal memory will automatically be allocated to the data objects. It is possible to change these addresses, but it is recommended to finish configuration using default values. If any collisions appear, the addresses can be changed at a later stage. The ACM will not allow you to add a data or a constant object, that is larger than the remaining data area in the selected frame.

8. Repeat according to step 7 to add frames and contents to 'Initialize 2', 'Cels/Farenh' and 'Temperature'.

9. Add transactions to Motor group.

The motor needs to be initialized. It also needs instructions during runtime, and it will return status information to the Communicator. It is also possible to remotely set the speed of the motor.

- Add a query-response transaction and rename it 'Initialize'.
- Select Query and change Update Mode to Single Shot.

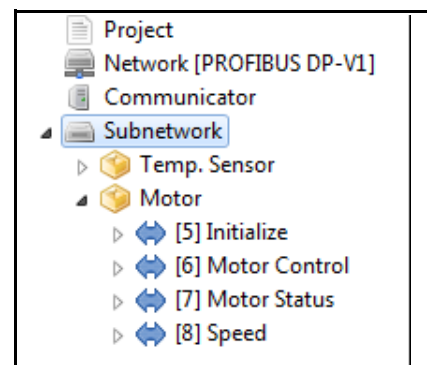

- Add one Query-Response transaction ("Motor Control") to control the motor during runtime.
- Set Update Mode to On Data Change.
- Add one Consume transaction ("Motor Status") to collect status cyclically from the motor.
- Finally add a Produce transaction ("Speed") to be able to change the speed of the motor.

10. Add frames to the transactions, see step 7 above.

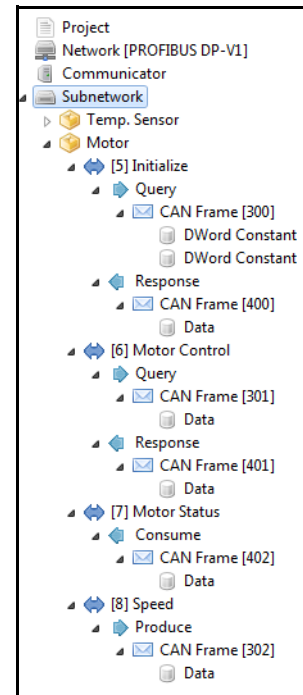

11. Check the validity of configuration in the Diagnostics/Status window.

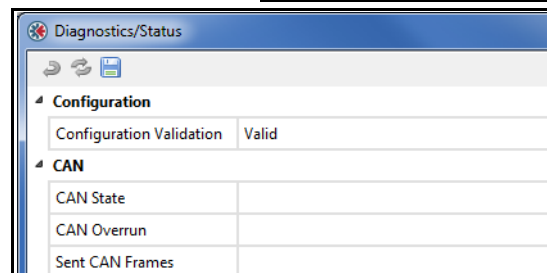

If address conflicts are present, check the Address Overview to see which transactions cause the conflict. Change the addresses of the data objects in the frames to remove conflicts.

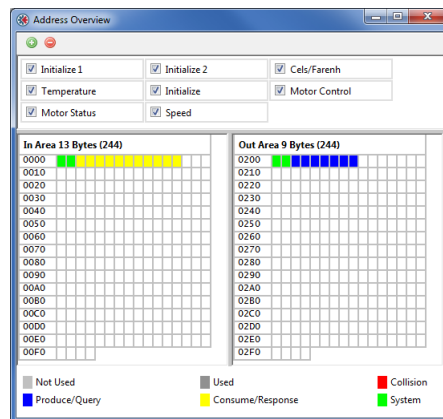

12. Download the configuration to the Communicator using the USB connection. Remove the USB cable when finished

A configuration can be saved at any time and opened at a later time for editing. Once it is valid it can be downloaded to the Anybus Communicator CAN.